

21st Balkan Karate Championships for Cadets, Juniors and  
U21 - RIJEKA 2021

2021.11.26 - 2021.11.28

RIJEKA

CROATIA,CRO















## 21st Balkan Karate Championships for Cadets, J ..

CROATIA  
RIJEKA

2021.11.26 - 2021.11.28

### NUMBER OF ENTRIES

| #              | Code  | Country                | Male Entries | Female Entries | Total Entries | Total Athletes |
|----------------|---|------------------------|--------------|----------------|---------------|----------------|
| 1              |  ALB | ALBANIA                | 3            | 2              | 5             | 5              |
| 2              |  BIH | BOSNIA AND HERZEGOVINA | 66           | 49             | 115           | 112            |
| 3              |  BUL | BULGARIA               | 16           | 10             | 26            | 23             |
| 4              |  CRO | CROATIA                | 64           | 54             | 118           | 114            |
| 5              |  CYP | CYPRUS                 | 4            | 2              | 6             | 6              |
| 6              |  GRE | GREECE                 | 32           | 35             | 67            | 57             |
| 7              |  KOS | KOSOVO                 | 30           | 27             | 57            | 47             |
| 8              |  MNE | MONTENEGRO             | 27           | 19             | 46            | 43             |
| 9              |  MKD | NORTH MACEDONIA        | 40           | 24             | 64            | 58             |
| 10             |  ROU | ROMANIA                | 24           | 19             | 43            | 35             |
| 11             |  SRB | SERBIA                 | 58           | 53             | 111           | 102            |
| 12             |  SLO | SLOVENIA               | 31           | 27             | 58            | 52             |
| 13             |  TUR | TURKEY                 | 22           | 21             | 43            | 42             |
| <b>Totals:</b> |   |                        | 417          | 342            | 759           | 696            |

# 21st Balkan Karate Championships for Cadets, J ..

CROATIA  
RIJEKA

2021.11.26 - 2021.11.28

## ENTRY LIST

|  <b>ALB - ALBANIA</b> |        |             |            |                             |
|---|--------|-------------|------------|-----------------------------|
| ID  | Gender | Family Name | Given Name | Event                       |
| ALB02386  | Male   | CANGA       | ALEKS      | CADET KUMITE MALE -57 KG    |
| ALB2221   | Male   | PJETRI      | ENRIK      | CADET KUMITE MALE -63 KG    |
| ALB02383  | Male   | PRODANI     | ALEKSANDER | CADET KUMITE MALE -70 KG    |
| ALB02311  | Female | DOKOLLARI   | GEA        | JUNIOR KUMITE FEMALE -59 KG |
| ALB02385  | Female | RUCI        | LAURA      | CADET KUMITE FEMALE -54 KG  |

Entries: 5

# 21st Balkan Karate Championships for Cadets, J ..

CROATIA  
RIJEKA

2021.11.26 - 2021.11.28

## ENTRY LIST

| BIH - BOSNIA AND HERZEGOVINA |        |             |            |                                 |
|------------------------------|--------|-------------|------------|---------------------------------|
| ID                           | Gender | Family Name | Given Name | Event                           |
| BIH2186                      | Male   | AHMETOVIC   | HAMZA      | JUNIOR KUMITE MALE -61 KG       |
| BIH03859                     | Male   | BARLOV      | ADIN       | JUNIOR KUMITE MALE -76 KG       |
| BIH03343                     | Male   | BAZINA      | ANTONIO    | JUNIOR KUMITE MALE 76+ KG       |
| BIH03343                     | Male   | BAZINA      | ANTONIO    | JUNIOR KUMITE TEAM MALE         |
| BIH03857                     | Male   | BEHADEROVIC | BAKIR      | CADET KUMITE MALE -52 KG        |
| BIH2362                      | Male   | BESIC       | HASIM      | JUNIOR KUMITE MALE 76+ KG       |
| BIH2362                      | Male   | BESIC       | HASIM      | JUNIOR KUMITE TEAM MALE         |
| BIH2695                      | Male   | BILANOVIC   | IMRAN      | CADET KUMITE MALE -70 KG        |
| BIH2179                      | Male   | BOSTANDZIC  | ANES       | JUNIOR KUMITE MALE 76+ KG       |
| BIH2179                      | Male   | BOSTANDZIC  | ANES       | JUNIOR KUMITE TEAM MALE         |
| BIH03262                     | Male   | CETIN       | ARMIN      | CADET KUMITE MALE 70+ KG        |
| BIH03866                     | Male   | CUBARA      | EMAN       | CADET KUMITE TEAM MALE          |
| BIH03870                     | Male   | CUKOVIC     | LUKA       | JUNIOR KUMITE MALE -55 KG       |
| BIH03851                     | Male   | DABIC       | MILAN      | CADET KUMITE MALE -70 KG        |
| BIH03851                     | Male   | DABIC       | MILAN      | CADET KUMITE TEAM MALE          |
| BIH2836                      | Male   | DELIC       | ALIJA      | U21 KUMITE MALE -75 KG          |
| BIH460                       | Male   | DUJAKOVIC   | PAVLE      | U21 KUMITE MALE -60 KG          |
| BIH2201                      | Male   | DZUHO       | MAHIR      | U21 KUMITE MALE -84 KG          |
| BIH2199                      | Male   | DZUHO       | RIJAD      | U21 KUMITE MALE 84+ KG          |
| BIH2199                      | Male   | DZUHO       | RIJAD      | Kumite Team male U21            |
| BIH2630                      | Male   | GAJANIN     | MILAN      | CADET KUMITE MALE -70 KG        |
| BIH03863                     | Male   | GARACA      | ANES       | CADET KUMITE MALE -63 KG        |
| BIH2386                      | Male   | GRABUS      | BAKIR      | U21 KUMITE MALE -75 KG          |
| BIH03860                     | Male   | HADZIC      | ALDIN      | CADET KUMITE MALE -63 KG        |
| BIH03865                     | Male   | HALILOVIC   | EMIR       | CADET KUMITE MALE -52 KG        |
| BIH2398                      | Male   | HALILOVIC   | HARIS      | JUNIOR KUMITE MALE -68 KG       |
| BIH03490                     | Male   | HALILOVIC   | MUAMER     | Junior Kata Male                |
| BIH2358                      | Male   | HALILOVIC   | OMAR       | JUNIOR KUMITE MALE -76 KG       |
| BIH2358                      | Male   | HALILOVIC   | OMAR       | JUNIOR KUMITE TEAM MALE         |
| BIH03489                     | Male   | HALILOVIC   | OSMAN      | U21 Kata Male                   |
| BIH2817                      | Male   | HODZIC      | AMAR       | CADET KUMITE TEAM MALE          |
| BIH2676                      | Male   | HUKARA      | SANJIN     | CADET KUMITE MALE -70 KG        |
| BIH2676                      | Male   | HUKARA      | SANJIN     | CADET KUMITE TEAM MALE          |
| BIH03480                     | Male   | IMSIROVIC   | DINO       | JUNIOR KUMITE MALE -68 KG       |
| BIH03169                     | Male   | JASAREVIC   | KERIM      | CADET KUMITE TEAM MALE          |
| BIH03436                     | Male   | JOVANOVIC   | SRDJAN     | U21 KUMITE MALE 84+ KG          |
| BIH03436                     | Male   | JOVANOVIC   | SRDJAN     | Kumite Team male U21            |
| BIH2573                      | Male   | KADRIC      | FARUK      | JUNIOR KUMITE MALE -55 KG       |
|                              | Male   | KATIC       | IVAN       | JUNIOR KUMITE MALE -76 KG       |
| BIH2797                      | Male   | KATIC       | TOMISLAV   | U21 KUMITE MALE -84 KG          |
| BIH2797                      | Male   | KATIC       | TOMISLAV   | Kumite Team male U21            |
| BIH03864                     | Male   | KOVAC       | ENIS       | CADET KUMITE MALE -63 KG        |
| BIH2361                      | Male   | KRESIC      | SANDRO     | U21 KUMITE MALE 84+ KG          |
| BIH2361                      | Male   | KRESIC      | SANDRO     | Kumite Team male U21            |
| BIH03869                     | Male   | KULENOVIC   | SERGEJ     | CADET KUMITE MALE 70+ KG        |
| BIH03342                     | Male   | LOVRIC      | LUKAS      | JUNIOR KUMITE MALE -61 KG       |
| BIH03200                     | Male   | LUGONIC     | ZEMIR      | KATA TEAM CADET AND JUNIOR MALE |

# 21st Balkan Karate Championships for Cadets, J ..

CROATIA  
RIJEKA

2021.11.26 - 2021.11.28

## ENTRY LIST

|          |        |            |            |   |
|----------|--------|------------|------------|---|
| BIH03200 | Male   | LUGONIC    | ZEMIR      | KATA TEAM CADET AND JUNIOR MALE R2 Bronze Medal Match 1 |
| BIH2151  | Male   | MARKOVIC   | LAZAR      | JUNIOR KUMITE MALE -68 KG                               |
| BIH2889  | Male   | MEHULJIC   | AMIR       | KATA TEAM CADET AND JUNIOR MALE                         |
| BIH2889  | Male   | MEHULJIC   | AMIR       | KATA TEAM CADET AND JUNIOR MALE R2 Bronze Medal Match 1 |
| BIH2337  | Male   | MEMISEVIC  | KENAN      | JUNIOR KUMITE MALE -68 KG                               |
| BIH03867 | Male   | MERDIC     | ISMAR      | U21 KUMITE MALE -67 KG                                  |
| BIH498   | Male   | MURADBASIC | HARIS      | U21 KUMITE MALE -84 KG                                  |
| BIH498   | Male   | MURADBASIC | HARIS      | Kumite Team male U21                                    |
| BIH2148  | Male   | NOVICKI    | ALEKSANDAR | JUNIOR KUMITE MALE 76+ KG                               |
| BIH2148  | Male   | NOVICKI    | ALEKSANDAR | JUNIOR KUMITE TEAM MALE                                 |
| BIH03855 | Male   | OMERINOVIC | EMAN       | CADET KUMITE MALE 70+ KG                                |
| BIH2500  | Male   | OMEROVIC   | BAKIR      | U21 KUMITE MALE -67 KG                                  |
| BIH2922  | Male   | PEJIC      | LUKA       | CADET KUMITE MALE -57 KG                                |
| BIH03469 | Male   | RAONIC     | ALEKSANDAR | JUNIOR KUMITE MALE -55 KG                               |
| BIH2892  | Male   | ROSIC      | RIJAD      | Cadet Kata Male   |
| BIH2892  | Male   | ROSIC      | RIJAD      | KATA TEAM CADET AND JUNIOR MALE                         |
| BIH2892  | Male   | ROSIC      | RIJAD      | KATA TEAM CADET AND JUNIOR MALE R2 Bronze Medal Match 1 |
| BIH2206  | Male   | SADIKOVIC  | EMIL       | U21 KUMITE MALE -84 KG                                  |
| BIH2980  | Male   | SADIKOVIC  | NADAL      | Cadet Kata Male   |
| BIH03488 | Male   | SALKANOVIC | OSMAN      | U21 Kata Male   |
| BIH2611  | Male   | SALKIC     | TARIK      | Cadet Kata Male   |
| BIH2611  | Male   | SALKIC     | TARIK      | CADET KUMITE MALE -63 KG                                |
| BIH2611  | Male   | SALKIC     | TARIK      | Cadet Kata Male R2-G1                                   |
| BIH2611  | Male   | SALKIC     | TARIK      | Cadet Kata Male R3 Bronze Medal Match 1                 |
| BIH2611  | Male   | SALKIC     | TARIK      | CADET KUMITE TEAM MALE                                  |
| BIH03861 | Male   | SAPINA     | LUKA       | CADET KUMITE MALE 70+ KG                                |
| BIH03873 | Male   | SEDIC      | TARIK      | CADET KUMITE MALE -57 KG                                |
| BIH03168 | Male   | SILJAK     | KENAN      | CADET KUMITE MALE -57 KG                                |
| BIH2620  | Male   | SMAJIC     | HARUN      | CADET KUMITE MALE -57 KG                                |
| BIH2112  | Male   | STANIC     | MIHAJLO    | JUNIOR KUMITE MALE -55 KG                               |
| BIH2112  | Male   | STANIC     | MIHAJLO    | JUNIOR KUMITE TEAM MALE                                 |
| BIH401   | Male   | SUMAR      | MUHAMED    | U21 KUMITE MALE -67 KG                                  |
| BIH2203  | Male   | TURULJA    | HAMZA      | U21 KUMITE MALE -75 KG                                  |
| BIH2203  | Male   | TURULJA    | HAMZA      | Kumite Team male U21                                    |
| BIH2218  | Male   | VELADZIC   | SENAID     | U21 Kata Male   |
| BIH2683  | Male   | VUJMILOVIC | KOSTA      | CADET KUMITE TEAM MALE                                  |
| BIH2204  | Male   | ZAIMOVIC   | ALIJA      | JUNIOR KUMITE MALE -76 KG                               |
| BIH2204  | Male   | ZAIMOVIC   | ALIJA      | JUNIOR KUMITE TEAM MALE                                 |
| BIH03876 | Male   | ZAIMOVIC   | AMIL       | CADET KUMITE MALE -52 KG                                |
| BIH3120  | Male   | ZIVKOVIC   | BRANKO     | U21 KUMITE MALE 84+ KG                                  |
| BIH3120  | Male   | ZIVKOVIC   | BRANKO     | Kumite Team male U21                                    |
| BIH2823  | Male   | ZOLOTA     | ISMAIL     | CADET KUMITE MALE -52 KG                                |
| BIH03493 | Male   | ZRNIC      | MIHAJLO    | JUNIOR KUMITE MALE -61 KG                               |
| BIH2178  | Male   | ZUKIC      | AFAN       | U21 KUMITE MALE -75 KG                                  |
| BIH2717  | Female | AVMEDOSKI  | MERJEM     | U21 KUMITE FEMALE 68+ KG                                |
| BIH03174 | Female | BARAKOVIC  | MEDINA     | CADET KUMITE FEMALE 54+ KG                              |
| BIH2124  | Female | BEGANOVIC  | AMILA      | U21 Kata Female   |
| BIH03588 | Female | BEGANOVIC  | NINA       | CADET KUMITE FEMALE -47 KG                              |

# 21st Balkan Karate Championships for Cadets, J ..

CROATIA  
RIJEKA

2021.11.26 - 2021.11.28

## ENTRY LIST

|          |        |              |          |   |
|----------|--------|--------------|----------|---|
| BIH03588 | Female | BEGANOVIC    | NINA     | CADET KUMITE TEAM FEMALE                                  |
| BIH341   | Female | BOROVCANIN   | ISIDORA  | U21 Kata Female   |
|          | Female | BRKAN        | NEJLA    | U21 KUMITE FEMALE 68+ KG                                  |
| BIH2639  | Female | BRKOVIC      | MERIMA   | CADET KUMITE FEMALE -47 KG                                |
| BIH03657 | Female | BUSNOV       | ALMEDINA | U21 KUMITE FEMALE -68 KG                                  |
| BIH03161 | Female | CARDAKOVIC   | SARAH    | JUNIOR KUMITE FEMALE -59 KG                               |
| BIH2408  | Female | CUCAK        | NIKOLINA | JUNIOR KUMITE FEMALE 59+ KG                               |
| BIH2408  | Female | CUCAK        | NIKOLINA | JUNIOR KUMITE TEAM FEMALE                                 |
| BIH2835  | Female | DAHALIC      | AZRA     | U21 KUMITE FEMALE -61 KG                                  |
| BIH2675  | Female | DURAKOVIC    | SEJMA    | Junior Kata Female  |
| BIH2600  | Female | DURDZIC      | IMANA    | Cadet Kata Female   |
| BIH03858 | Female | GUSO         | DZEJLAN  | JUNIOR KUMITE FEMALE -59 KG                               |
| BIH03485 | Female | HALILOVIC    | ALMINA   | U21 KUMITE FEMALE -55 KG                                  |
| BIH2357  | Female | HALILOVIC    | ELVEDINA | U21 KUMITE FEMALE -68 KG                                  |
| BIH2357  | Female | HALILOVIC    | ELVEDINA | Kumite Team female U21                                    |
| BIH03852 | Female | HRBAT        | ELMEDINA | JUNIOR KUMITE FEMALE -48 KG                               |
| BIH03222 | Female | HUSEJINOVIC  | AMINA    | CADET KUMITE FEMALE -54 KG                                |
| BIH2948  | Female | IBRAHIMOVIC  | MELINA   | JUNIOR KUMITE FEMALE 59+ KG                               |
| BIH03477 | Female | KAPO         | HANA     | U21 KUMITE FEMALE -68 KG                                  |
| BIH2644  | Female | KAVAZ        | INELA    | CADET KUMITE FEMALE 54+ KG                                |
| BIH2848  | Female | KELESTURA    | SEMINA   | U21 Kata Female   |
| BIH2269  | Female | KRESIC       | STEFANI  | U21 KUMITE FEMALE 68+ KG                                  |
| BIH2269  | Female | KRESIC       | STEFANI  | Kumite Team female U21                                    |
| BIH3053  | Female | KURTES       | MARINA   | U21 KUMITE FEMALE -61 KG                                  |
| BIH3053  | Female | KURTES       | MARINA   | Kumite Team female U21                                    |
| BIH2895  | Female | LEKANIC      | SELENA   | JUNIOR KUMITE FEMALE 59+ KG                               |
| BIH2895  | Female | LEKANIC      | SELENA   | JUNIOR KUMITE TEAM FEMALE                                 |
| BIH2708  | Female | MUHOVIC      | NADJA    | CADET KUMITE FEMALE 54+ KG                                |
| BIH2708  | Female | MUHOVIC      | NADJA    | CADET KUMITE TEAM FEMALE                                  |
| BIH03874 | Female | MUJAKOVIC    | NEJLA    | U21 KUMITE FEMALE -61 KG                                  |
| BIH3010  | Female | MUJANOVIC    | IRNA     | CADET KUMITE FEMALE -47 KG                                |
| BIH03228 | Female | PASALIC      | ESMA     | Cadet Kata Female   |
| BIH2674  | Female | PESTALIC     | MERJEMA  | Cadet Kata Female   |
| BIH2674  | Female | PESTALIC     | MERJEMA  | KATA TEAM CADET AND JUNIOR FEMALE                         |
| BIH2674  | Female | PESTALIC     | MERJEMA  | KATA TEAM CADET AND JUNIOR FEMALE R2 Bronze Medal Match 2 |
| BIH03236 | Female | POZDERAC     | NINA     | CADET KUMITE FEMALE -54 KG                                |
| BIH03236 | Female | POZDERAC     | NINA     | CADET KUMITE TEAM FEMALE                                  |
| BIH2326  | Female | RAJIC        | MONIKA   | U21 KUMITE FEMALE -61 KG                                  |
| BIH03856 | Female | RASIDBEGOVIC | MUBINA   | JUNIOR KUMITE FEMALE -53 KG                               |
| BIH03591 | Female | SALIHOVIC    | ALDIJANA | KATA TEAM CADET AND JUNIOR FEMALE                         |
| BIH03591 | Female | SALIHOVIC    | ALDIJANA | KATA TEAM CADET AND JUNIOR FEMALE R2 Bronze Medal Match 2 |
| BIH2678  | Female | SARKINOVIC   | UNA      | Junior Kata Female  |
| BIH2678  | Female | SARKINOVIC   | UNA      | JUNIOR KUMITE FEMALE -59 KG                               |
| BIH2604  | Female | SIPOVIC      | AJLA     | CADET KUMITE FEMALE -54 KG                                |
| BIH2110  | Female | SIPOVIC      | EMINA    | JUNIOR KUMITE FEMALE -53 KG                               |
| BIH2110  | Female | SIPOVIC      | EMINA    | JUNIOR KUMITE TEAM FEMALE                                 |
| BIH2111  | Female | SIPOVIC      | NEJRA    | U21 KUMITE FEMALE -55 KG                                  |
| BIH2111  | Female | SIPOVIC      | NEJRA    | Kumite Team female U21                                    |

## 21st Balkan Karate Championships for Cadets, J ..

CROATIA  
RIJEKA

2021.11.26 - 2021.11.28

### ENTRY LIST

|          |        |            |           |   |
|----------|--------|------------|-----------|---|
| BIH2379  | Female | SOFTIC     | DINKA     | JUNIOR KUMITE FEMALE -59 KG                               |
| BIH2379  | Female | SOFTIC     | DINKA     | JUNIOR KUMITE TEAM FEMALE                                 |
| BIH2673  | Female | STANOJEVIC | KRISTINA  | Cadet Kata Female   |
| BIH2673  | Female | STANOJEVIC | KRISTINA  | KATA TEAM CADET AND JUNIOR FEMALE                         |
| BIH2673  | Female | STANOJEVIC | KRISTINA  | KATA TEAM CADET AND JUNIOR FEMALE R2 Bronze Medal Match 2 |
| BIH2390  | Female | TANOVIC    | EMINA     | Junior Kata Female  |
| BIH2390  | Female | TANOVIC    | EMINA     | Junior Kata Female R2-G2                                  |
| BIH2910  | Female | TOPIC      | KAJA      | CADET KUMITE FEMALE 54+ KG                                |
| BIH2910  | Female | TOPIC      | KAJA      | CADET KUMITE TEAM FEMALE                                  |
| BIH03862 | Female | VESIC      | MAGDALENA | JUNIOR KUMITE FEMALE -48 KG                               |
| BIH2602  | Female | ZENUNOVIC  | LARISA    | CADET KUMITE FEMALE -54 KG                                |
| BIH03853 | Female | ZIGIC      | AJNA      | JUNIOR KUMITE FEMALE -53 KG                               |

Entries: **155**

# 21st Balkan Karate Championships for Cadets, J ..

CROATIA  
RIJEKA

2021.11.26 - 2021.11.28

## ENTRY LIST

|  <b>BUL - BULGARIA</b> |        |             |            |                            |
|--|--------|-------------|------------|----------------------------|
| ID   | Gender | Family Name | Given Name | Event                      |
| BUL02454   | Male   | ATANASOV    | TEODOR     | CADET KUMITE MALE 70+ KG   |
| BUL02454   | Male   | ATANASOV    | TEODOR     | CADET KUMITE TEAM MALE     |
| BUL2162  | Male   | HANDZHIEV   | VIKTOR     | JUNIOR KUMITE MALE -76 KG  |
| BUL2305  | Male   | HRISTAKIEV  | ALEKSANDER | CADET KUMITE MALE -57 KG   |
| BUL2305  | Male   | HRISTAKIEV  | ALEKSANDER | CADET KUMITE TEAM MALE     |
| BUL2161  | Male   | IVANOV      | VELIN      | JUNIOR KUMITE MALE -55 KG  |
| BUL2139  | Male   | MATUSKI     | GEORGI     | Junior Kata Male           |
| BUL2306  | Male   | MIHAYLOV    | PETAR      | CADET KUMITE MALE -52 KG   |
| BUL2306  | Male   | MIHAYLOV    | PETAR      | CADET KUMITE TEAM MALE     |
| BUL2219  | Male   | MILENKOV    | DEYAN      | CADET KUMITE MALE -70 KG   |
| BUL2219  | Male   | MILENKOV    | DEYAN      | CADET KUMITE TEAM MALE     |
| BUL2061  | Male   | NASTEV      | TODOR      | U21 KUMITE MALE -60 KG     |
| BUL2075  | Male   | PETKOV      | IVAN       | U21 KUMITE MALE -67 KG     |
| BUL2073  | Male   | PETROV      | ROBERTO    | U21 KUMITE MALE 84+ KG     |
| BUL2133  | Male   | STEFANOV    | ALEKSANDAR | JUNIOR KUMITE MALE -68 KG  |
| BUL2255  | Male   | STOIMENOV   | MIHAIL     | CADET KUMITE MALE -57 KG   |
| BUL2255  | Male   | STOIMENOV   | MIHAIL     | CADET KUMITE TEAM MALE     |
| BUL376   | Male   | STOYANOV    | DENISLAV   | U21 KUMITE MALE -60 KG     |
| BUL2256  | Male   | VAKARELOV   | VLADISLAV  | CADET KUMITE MALE -63 KG   |
| BUL2256  | Male   | VAKARELOV   | VLADISLAV  | CADET KUMITE TEAM MALE     |
| BUL2218  | Male   | VASILEV     | HRISTIAN   | CADET KUMITE MALE -57 KG   |
| BUL2218  | Male   | VASILEV     | HRISTIAN   | CADET KUMITE TEAM MALE     |
| BUL2336  | Female | HRISTOVA    | IREN       | U21 KUMITE FEMALE -50 KG   |
| BUL02721   | Female | ILIEVA      | VIKTORIA   | CADET KUMITE FEMALE -47 KG |
| BUL02458   | Female | KOSTOVA     | VELIZARA   | Cadet Kata Female          |
| BUL02458   | Female | KOSTOVA     | VELIZARA   | CADET KUMITE FEMALE -54 KG |
| BUL02458   | Female | KOSTOVA     | VELIZARA   | CADET KUMITE TEAM FEMALE   |
| BUL2307  | Female | STOIMENOVA  | VENETA     | CADET KUMITE FEMALE 54+ KG |
| BUL2307  | Female | STOIMENOVA  | VENETA     | CADET KUMITE TEAM FEMALE   |
| BUL02757   | Female | STOYANOVA   | YOANNA     | CADET KUMITE FEMALE 54+ KG |
| BUL02757   | Female | STOYANOVA   | YOANNA     | CADET KUMITE TEAM FEMALE   |
| BUL02756   | Female | TOSHEVA     | VICTORIA   | CADET KUMITE FEMALE -47 KG |
| BUL2210  | Female | TSANEVA     | TEODORA    | CADET KUMITE FEMALE -54 KG |
| BUL2210  | Female | TSANEVA     | TEODORA    | CADET KUMITE TEAM FEMALE   |
| BUL02755   | Female | ZLATKOVA    | LIDIA      | CADET KUMITE FEMALE -47 KG |

Entries: 35



## 21st Balkan Karate Championships for Cadets, J ..

CROATIA  
RIJEKA

2021.11.26 - 2021.11.28

# ENTRY LIST

| CRO - CROATIA |        |               |              |   |
|---------------|--------|---------------|--------------|---|
| ID            | Gender | Family Name   | Given Name   | Event   |
| CRO2083       | Male   | BAZDARIC      | ANTON        | U21 KUMITE MALE 84+ KG                                  |
| CRO03083      | Male   | BOGAT         | MARTIN       | CADET KUMITE MALE -70 KG                                |
| CRO03083      | Male   | BOGAT         | MARTIN       | CADET KUMITE TEAM MALE                                  |
| CRO03281      | Male   | BRAVARIC CILO | DAMJAN       | Junior Kata Male  |
| CRO03281      | Male   | BRAVARIC CILO | DAMJAN       | KATA TEAM CADET AND JUNIOR MALE                         |
| CRO03281      | Male   | BRAVARIC CILO | DAMJAN       | KATA TEAM CADET AND JUNIOR MALE R2 Bronze Medal Match 2 |
|               | Male   | CIPRIC        | LUKA STEFANO | U21 KUMITE MALE -84 KG                                  |
| CRO2753       | Male   | CIPRIC        | LUKA STEFANO | U21 KUMITE MALE -84 KG                                  |
| CRO2851       | Male   | CULE          | OLIVER       | U21 KUMITE MALE 84+ KG                                  |
| CRO03057      | Male   | CUTURA        | TONI         | CADET KUMITE MALE 70+ KG                                |
| CRO03057      | Male   | CUTURA        | TONI         | CADET KUMITE TEAM MALE                                  |
| CRO2533       | Male   | DONADIC       | NINO         | JUNIOR KUMITE MALE -55 KG                               |
| CRO03389      | Male   | DRAZENOVIC    | DAMIAN       | CADET KUMITE MALE -57 KG                                |
| CRO03279      | Male   | DUBRAVCIC     | AXEL ADAM    | JUNIOR KUMITE MALE -76 KG                               |
| CRO03279      | Male   | DUBRAVCIC     | AXEL ADAM    | JUNIOR KUMITE TEAM MALE                                 |
| CRO2279       | Male   | ECIMOVIC      | MIHAEL       | U21 Kata Male   |
| CRO2279       | Male   | ECIMOVIC      | MIHAEL       | Kata Team male U21                                      |
| CRO2444       | Male   | FAJERBACH     | MAX          | JUNIOR KUMITE MALE 76+ KG                               |
| CRO2444       | Male   | FAJERBACH     | MAX          | JUNIOR KUMITE TEAM MALE                                 |
| CRO2446       | Male   | FARKAS        | LOVRO        | JUNIOR KUMITE MALE -61 KG                               |
| CRO2641       | Male   | FILES         | MARK         | Cadet Kata Male   |
| CRO2641       | Male   | FILES         | MARK         | Cadet Kata Male R2-G1                                   |
| CRO2634       | Male   | FRANK         | KRISTIJAN    | CADET KUMITE MALE -63 KG                                |
| CRO2634       | Male   | FRANK         | KRISTIJAN    | CADET KUMITE TEAM MALE                                  |
| CRO03237      | Male   | GARAJ         | IVAN         | CADET KUMITE MALE -70 KG                                |
| CRO2226       | Male   | GLUHINIC      | DARIO        | U21 KUMITE MALE 84+ KG                                  |
| CRO2226       | Male   | GLUHINIC      | DARIO        | Kumite Team male U21                                    |
| CRO2855       | Male   | GOLUBIC       | LEONARD      | CADET KUMITE MALE -57 KG                                |
| CRO2872       | Male   | GONDI         | NIKOLA       | CADET KUMITE MALE 70+ KG                                |
| CRO2872       | Male   | GONDI         | NIKOLA       | CADET KUMITE TEAM MALE                                  |
| CRO03368      | Male   | GUDELJ        | PETAR        | JUNIOR KUMITE MALE -76 KG                               |
| CRO03368      | Male   | GUDELJ        | PETAR        | JUNIOR KUMITE TEAM MALE                                 |
| CRO03015      | Male   | HUIC          | DINO         | Cadet Kata Male   |
| CRO03015      | Male   | HUIC          | DINO         | Cadet Kata Male R2-G1                                   |
| CRO03015      | Male   | HUIC          | DINO         | Cadet Kata Male R3 Bronze Medal Match 2                 |
| CRO2856       | Male   | HUZANIC       | IVAN         | JUNIOR KUMITE MALE -76 KG                               |
| CRO2857       | Male   | IVANIC        | VALENTINO    | JUNIOR KUMITE MALE -61 KG                               |
| CRO03065      | Male   | KADIC         | BARTOL       | CADET KUMITE MALE -63 KG                                |
| CRO2414       | Male   | KALABIC       | ALEKSANDAR   | U21 KUMITE MALE -84 KG                                  |
| CRO2414       | Male   | KALABIC       | ALEKSANDAR   | Kumite Team male U21                                    |
| CRO2299       | Male   | KATANEC       | JAN          | JUNIOR KUMITE MALE 76+ KG                               |
| CRO2299       | Male   | KATANEC       | JAN          | JUNIOR KUMITE TEAM MALE                                 |
| CRO03546      | Male   | KAURIN        | FILIP        | CADET KUMITE MALE -63 KG                                |
| CRO03549      | Male   | KEKO          | LUKA         | Cadet Kata Male   |
| CRO03549      | Male   | KEKO          | LUKA         | KATA TEAM CADET AND JUNIOR MALE                         |

# 21st Balkan Karate Championships for Cadets, J ..

CROATIA  
RIJEKA

2021.11.26 - 2021.11.28

## ENTRY LIST

|          |        |                 |          |   |
|----------|--------|-----------------|----------|---|
| CRO03549 | Male   | KEKO            | LUKA     | KATA TEAM CADET AND JUNIOR MALE R2 Bronze Medal Match 2 |
| CRO2719  | Male   | KOKIC           | PATRIK   | Kata Team male U21                                      |
| CRO2106  | Male   | KOSCEVIC        | LUKA     | U21 Kata Male   |
| CRO03144 | Male   | KVESIC          | LUKA     | JUNIOR KUMITE MALE 76+ KG                               |
| CRO03144 | Male   | KVESIC          | LUKA     | JUNIOR KUMITE TEAM MALE                                 |
| CRO2202  | Male   | LAZAR           | LEO      | U21 KUMITE MALE -84 KG                                  |
| CRO2202  | Male   | LAZAR           | LEO      | Kumite Team male U21                                    |
| CRO2119  | Male   | MARKOVIC        | LEO      | U21 KUMITE MALE -75 KG                                  |
| CRO2820  | Male   | MASLOV          | LOVRO    | CADET KUMITE MALE -52 KG                                |
| CRO2525  | Male   | MILINOVICH      | DAVID    | JUNIOR KUMITE MALE -61 KG                               |
| CRO03197 | Male   | NASTESKI        | MATIJA   | JUNIOR KUMITE MALE -61 KG                               |
| CRO03242 | Male   | NEDIC           | LEON     | CADET KUMITE MALE -70 KG                                |
| CRO2576  | Male   | ORESKOVIC       | PETAR    | U21 KUMITE MALE -67 KG                                  |
| CRO2599  | Male   | PARLOV          | NIKOLA   | KATA TEAM CADET AND JUNIOR MALE                         |
| CRO2599  | Male   | PARLOV          | NIKOLA   | KATA TEAM CADET AND JUNIOR MALE R2 Bronze Medal Match 2 |
|          | Male   | PEHAR           | IVAN     | U21 KUMITE MALE 84+ KG                                  |
| CRO2224  | Male   | PEHAR           | IVAN     | Kumite Team male U21                                    |
| CRO03027 | Male   | PERVAN          | ZELJKO   | CADET KUMITE MALE -52 KG                                |
| CRO03130 | Male   | PLESIVCAK       | MISLAV   | CADET KUMITE MALE 70+ KG                                |
| CRO2617  | Male   | PREMEC          | IVOR     | Kata Team male U21                                      |
| CRO2223  | Male   | PRUSINA         | IVAN     | JUNIOR KUMITE MALE -76 KG                               |
| CRO2222  | Male   | PUCE            | JURE     | JUNIOR KUMITE MALE 76+ KG                               |
| CRO03148 | Male   | RUMENJAK        | NOA      | U21 KUMITE MALE -60 KG                                  |
| CRO03548 | Male   | SARAVANJA       | MATE     | JUNIOR KUMITE MALE -55 KG                               |
| CRO2096  | Male   | SIMUNEC         | DINO     | U21 KUMITE MALE -75 KG                                  |
| CRO2096  | Male   | SIMUNEC         | DINO     | Kumite Team male U21                                    |
| CRO2711  | Male   | SIPIC           | LUKA     | JUNIOR KUMITE MALE -68 KG                               |
| CRO2234  | Male   | SLUKIC          | JOSIP    | JUNIOR KUMITE MALE -68 KG                               |
| CRO2234  | Male   | SLUKIC          | JOSIP    | JUNIOR KUMITE TEAM MALE                                 |
| CRO2512  | Male   | SONJE           | DOMINIK  | CADET KUMITE MALE -63 KG                                |
| CRO2512  | Male   | SONJE           | DOMINIK  | CADET KUMITE TEAM MALE                                  |
| CRO2127  | Male   | SOPER           | ERIK     | Junior Kata Male  |
| CRO2660  | Male   | STRAHIJA        | SVEN     | CADET KUMITE MALE -70 KG                                |
| CRO2660  | Male   | STRAHIJA        | SVEN     | CADET KUMITE TEAM MALE                                  |
| CRO2122  | Male   | TERHAJ          | IVAN     | JUNIOR KUMITE MALE -68 KG                               |
| CRO2122  | Male   | TERHAJ          | IVAN     | JUNIOR KUMITE TEAM MALE                                 |
| CRO395   | Male   | TOMLJANOVIC     | LEON     | U21 KUMITE MALE -84 KG                                  |
| CRO395   | Male   | TOMLJANOVIC     | LEON     | Kumite Team male U21                                    |
| CRO2264  | Male   | TOMLJANOVIC     | LUKA     | U21 KUMITE MALE -67 KG                                  |
| CRO2235  | Male   | TOPLICANEC      | KRISTIAN | U21 KUMITE MALE -60 KG                                  |
| CRO2445  | Male   | TOPLICANEC      | NIKOLA   | JUNIOR KUMITE MALE -55 KG                               |
| CRO2809  | Male   | TOTH            | MATEJ    | Cadet Kata Male   |
| CRO2648  | Male   | VASILJ          | ANDRIJA  | JUNIOR KUMITE MALE -68 KG                               |
| CRO03547 | Male   | VITELIC PAPRIKA | TIBOR    | CADET KUMITE MALE 70+ KG                                |
| CRO03547 | Male   | VITELIC PAPRIKA | TIBOR    | CADET KUMITE TEAM MALE                                  |
|          | Male   | VUJEVIC         | ANTUN    | U21 KUMITE MALE -75 KG                                  |
| CRO2630  | Male   | VUJEVIC         | ANTUN    | Kumite Team male U21                                    |
| CRO2210  | Female | BATTAIA         | LUCIA    | U21 KUMITE FEMALE -68 KG                                |

# 21st Balkan Karate Championships for Cadets, J ..

CROATIA  
RIJEKA

2021.11.26 - 2021.11.28

## ENTRY LIST

|          |        |             |            |   |
|----------|--------|-------------|------------|---|
| CRO2827  | Female | BESLIJA     | NIKA       | CADET KUMITE FEMALE -54 KG                                |
| CRO2827  | Female | BESLIJA     | NIKA       | CADET KUMITE TEAM FEMALE                                  |
| CRO2610  | Female | BOCKOR      | EMMA BERTA | Cadet Kata Female   |
| CRO2610  | Female | BOCKOR      | EMMA BERTA | Cadet Kata Female R2-G1                                   |
| CRO2507  | Female | BRAJA       | KLARA      | Junior Kata Female  |
| CRO2507  | Female | BRAJA       | KLARA      | Junior Kata Female R2-G1                                  |
| CRO2507  | Female | BRAJA       | KLARA      | Junior Kata Female R3-G1                                  |
| CRO2507  | Female | BRAJA       | KLARA      | Junior Kata Female R4 Bronze Medal Match 1                |
| CRO2598  | Female | BUNJEVAC    | LUCIJA     | U21 KUMITE FEMALE -61 KG                                  |
| CRO2627  | Female | CACKO       | MIA        | JUNIOR KUMITE FEMALE -59 KG                               |
| CRO03550 | Female | ECIMOVIC    | MATEA      | U21 Kata Female   |
| CRO03550 | Female | ECIMOVIC    | MATEA      | U21 Kata Female R2-G2                                     |
| CRO2640  | Female | FILIPOVIC   | ANA        | JUNIOR KUMITE FEMALE 59+ KG                               |
| CRO2457  | Female | GOLOMBOS    | NIKOLINA   | JUNIOR KUMITE FEMALE 59+ KG                               |
| CRO2457  | Female | GOLOMBOS    | NIKOLINA   | JUNIOR KUMITE TEAM FEMALE                                 |
| CRO2259  | Female | GRGIC       | BARBARA    | U21 KUMITE FEMALE -61 KG                                  |
| CRO2281  | Female | GRGIC       | INGA       | KATA TEAM CADET AND JUNIOR FEMALE                         |
| CRO2281  | Female | GRGIC       | INGA       | KATA TEAM CADET AND JUNIOR FEMALE R2 Bronze Medal Match 1 |
| CRO03006 | Female | GULIJA      | LEONA      | JUNIOR KUMITE FEMALE 59+ KG                               |
| CRO2886  | Female | HORVAT      | IVONA      | CADET KUMITE FEMALE 54+ KG                                |
| CRO2282  | Female | HORVAT      | STELA      | Junior Kata Female  |
| CRO2282  | Female | HORVAT      | STELA      | Junior Kata Female R2-G2                                  |
| CRO2282  | Female | HORVAT      | STELA      | KATA TEAM CADET AND JUNIOR FEMALE                         |
| CRO2282  | Female | HORVAT      | STELA      | KATA TEAM CADET AND JUNIOR FEMALE R2 Bronze Medal Match 1 |
| CRO2206  | Female | JURICIC     | EMA        | U21 KUMITE FEMALE -61 KG                                  |
| CRO03382 | Female | KIRINIC     | LUCIJA     | CADET KUMITE FEMALE -47 KG                                |
| CRO03132 | Female | KLARIC      | KORINA     | CADET KUMITE FEMALE -54 KG                                |
| CRO03140 | Female | KOCKAREVIC  | LANA       | JUNIOR KUMITE FEMALE -48 KG                               |
| CRO2638  | Female | KOVAC       | IRIS       | JUNIOR KUMITE FEMALE -59 KG                               |
| CRO2638  | Female | KOVAC       | IRIS       | JUNIOR KUMITE TEAM FEMALE                                 |
| CRO2416  | Female | LISAC       | LAURA      | JUNIOR KUMITE FEMALE -59 KG                               |
| CRO2416  | Female | LISAC       | LAURA      | JUNIOR KUMITE TEAM FEMALE                                 |
| CRO03408 | Female | LUJIC       | ANA        | Cadet Kata Female   |
| CRO03408 | Female | LUJIC       | ANA        | CADET KUMITE FEMALE -47 KG                                |
| CRO03408 | Female | LUJIC       | ANA        | CADET KUMITE TEAM FEMALE                                  |
| CRO2838  | Female | LUKENDA     | NINA       | JUNIOR KUMITE FEMALE 59+ KG                               |
| CRO2300  | Female | MAJSEC      | ISKRA      | JUNIOR KUMITE FEMALE -53 KG                               |
| CRO2249  | Female | MAMELEDZIJA | TIA        | JUNIOR KUMITE FEMALE -53 KG                               |
| CRO2830  | Female | MANDIC      | MARIJA     | CADET KUMITE FEMALE 54+ KG                                |
| CRO2966  | Female | MARTINOVIC  | GABRIELA   | U21 KUMITE FEMALE -50 KG                                  |
| CRO2201  | Female | NUIC        | PETRA      | U21 KUMITE FEMALE -61 KG                                  |
| CRO2201  | Female | NUIC        | PETRA      | Kumite Team female U21                                    |
| CRO2273  | Female | PALIAGA     | FLAVIA     | Junior Kata Female  |
| CRO2273  | Female | PALIAGA     | FLAVIA     | Junior Kata Female R2-G2                                  |
| CRO2273  | Female | PALIAGA     | FLAVIA     | KATA TEAM CADET AND JUNIOR FEMALE                         |
| CRO2273  | Female | PALIAGA     | FLAVIA     | KATA TEAM CADET AND JUNIOR FEMALE R2 Bronze Medal Match 1 |
| CRO03241 | Female | PEROVIC     | LUCIJA     | JUNIOR KUMITE FEMALE -48 KG                               |
| CRO2585  | Female | POLONIJO    | STELLA     | U21 KUMITE FEMALE -50 KG                                  |

# 21st Balkan Karate Championships for Cadets, J ..

CROATIA  
RIJEKA

2021.11.26 - 2021.11.28

## ENTRY LIST

|          |        |                   |           |   |
|----------|--------|-------------------|-----------|---|
| CRO03369 | Female | PRUSINA           | JANA      | JUNIOR KUMITE FEMALE -53 KG               |
| CRO2884  | Female | RAGUZ             | IVANA     | U21 Kata Female                           |
| CRO2884  | Female | RAGUZ             | IVANA     | U21 Kata Female R2-G1                     |
| CRO2884  | Female | RAGUZ             | IVANA     | U21 Kata Female R3 Bronze Medal Match 2   |
| CRO2644  | Female | REZIC             | DORA      | JUNIOR KUMITE FEMALE -48 KG               |
| CRO03040 | Female | RUMENJAK          | RAFAELA   | CADET KUMITE FEMALE -54 KG                |
| CRO03390 | Female | SAMBOL            | IVONA     | CADET KUMITE FEMALE 54+ KG                |
| CRO03371 | Female | SEGAVCIC          | KATIA     | Cadet Kata Female                         |
| CRO03371 | Female | SEGAVCIC          | KATIA     | Cadet Kata Female R2-G2                   |
| CRO03371 | Female | SEGAVCIC          | KATIA     | Cadet Kata Female R3 Bronze Medal Match 1 |
| CRO2209  | Female | SGARDELLI         | EMA       | JUNIOR KUMITE FEMALE -53 KG               |
| CRO2209  | Female | SGARDELLI         | EMA       | JUNIOR KUMITE TEAM FEMALE                 |
| CRO2829  | Female | SGARDELLI LJATIFI | TEA       | CADET KUMITE FEMALE -47 KG                |
| CRO03243 | Female | SMOLCIC           | TIA       | CADET KUMITE FEMALE -47 KG                |
| CRO2086  | Female | SOGORIC           | PAULA     | U21 KUMITE FEMALE 68+ KG                  |
|          | Female | STIVIC            | EMA       | U21 KUMITE FEMALE -55 KG                  |
| CRO2098  | Female | SULEK             | TIHANA    | U21 KUMITE FEMALE -55 KG                  |
| CRO2098  | Female | SULEK             | TIHANA    | Kumite Team female U21                    |
| CRO2253  | Female | SUTIC             | LINA      | U21 KUMITE FEMALE -68 KG                  |
| CRO2841  | Female | TOMIC             | SARA      | CADET KUMITE FEMALE 54+ KG                |
| CRO2841  | Female | TOMIC             | SARA      | CADET KUMITE TEAM FEMALE                  |
| CRO2932  | Female | VAJDA             | MAGDALENA | CADET KUMITE FEMALE -54 KG                |
| CRO2932  | Female | VAJDA             | MAGDALENA | CADET KUMITE TEAM FEMALE                  |
| CRO2250  | Female | VUKOJA            | LEA       | U21 KUMITE FEMALE -68 KG                  |
| CRO2250  | Female | VUKOJA            | LEA       | Kumite Team female U21                    |
| CRO2764  | Female | WEISMANN          | LARA      | U21 KUMITE FEMALE -50 KG                  |
| CRO2852  | Female | WEISMANN          | LUNA      | U21 KUMITE FEMALE -55 KG                  |
| CRO2243  | Female | ZORKO             | MIA GRETA | U21 KUMITE FEMALE 68+ KG                  |
| CRO2243  | Female | ZORKO             | MIA GRETA | Kumite Team female U21                    |
| CRO03147 | Female | ZUGCIC            | DORA      | JUNIOR KUMITE FEMALE -59 KG               |

Entries: 171

# 21st Balkan Karate Championships for Cadets, J ..

CROATIA  
RIJEKA

2021.11.26 - 2021.11.28

## ENTRY LIST

|  CYP - CYPRUS |        |             |                 |                             |
|---|--------|-------------|-----------------|-----------------------------|
| ID  | Gender | Family Name | Given Name      | Event                       |
| CYP2159   | Male   | IOANNOU     | PANOS           | U21 KUMITE MALE 84+ KG      |
| CYP2132   | Male   | KITSIOS     | CHRISTOFOROS    | JUNIOR KUMITE MALE -68 KG   |
| CYP2233   | Male   | NICOLAOU    | IASONAS IOANNIS | JUNIOR KUMITE MALE -68 KG   |
| CYP2333   | Male   | THEOCHAROUS | KYPRIANOS       | JUNIOR KUMITE MALE -61 KG   |
| CYP2210   | Female | KOKKINIDOU  | ATHENA          | JUNIOR KUMITE FEMALE -53 KG |
| CYP2209   | Female | STYLIANOU   | MARIA           | CADET KUMITE FEMALE 54+ KG  |

Entries: 6

# 21st Balkan Karate Championships for Cadets, J ..

CROATIA  
RIJEKA

2021.11.26 - 2021.11.28

## ENTRY LIST

|  <b>GRE - GREECE</b> |        |                |                  |  |
|--|--------|----------------|------------------|--|
| ID   | Gender | Family Name    | Given Name       | Event                                    |
| GRE02730   | Male   | ASIMAKOPOULOS  | ASIMAKIS         | JUNIOR KUMITE MALE -55 KG                |
| GRE02730   | Male   | ASIMAKOPOULOS  | ASIMAKIS         | JUNIOR KUMITE TEAM MALE                  |
| GRE02640   | Male   | ATHANASOULIAS  | KONSTANTINOS     | CADET KUMITE MALE -52 KG                 |
| GRE2156  | Male   | BITSORIS       | ANDREAS          | CADET KUMITE MALE -63 KG                 |
| GRE2156  | Male   | BITSORIS       | ANDREAS          | CADET KUMITE TEAM MALE                   |
| GRE2264  | Male   | CHONDROGIORGOS | NIKOLAOS         | U21 Kata Male                            |
| GRE2072  | Male   | GIANNAKOS      | THEOHARIS        | U21 KUMITE MALE -75 KG                   |
| GRE2072  | Male   | GIANNAKOS      | THEOHARIS        | Kumite Team male U21                     |
| GRE2142  | Male   | KAMPOUGERIS    | CHARALAMPOS      | U21 KUMITE MALE -75 KG                   |
| GRE2142  | Male   | KAMPOUGERIS    | CHARALAMPOS      | Kumite Team male U21                     |
| GRE02456   | Male   | KARRAS         | PETROS           | CADET KUMITE MALE -57 KG                 |
| GRE02456   | Male   | KARRAS         | PETROS           | CADET KUMITE TEAM MALE                   |
| GRE722   | Male   | KARVOUNIS      | SERGIOS          | U21 KUMITE MALE 84+ KG                   |
| GRE722   | Male   | KARVOUNIS      | SERGIOS          | Kumite Team male U21                     |
| GRE02447   | Male   | KATSAKOULAS    | CHRISTOFOROS     | JUNIOR KUMITE MALE -76 KG                |
| GRE02447   | Male   | KATSAKOULAS    | CHRISTOFOROS     | JUNIOR KUMITE TEAM MALE                  |
| GRE02315   | Male   | KIOUPELIS      | DIMITRIOS        | JUNIOR KUMITE MALE -61 KG                |
| GRE02315   | Male   | KIOUPELIS      | DIMITRIOS        | JUNIOR KUMITE TEAM MALE                  |
| GRE2220  | Male   | KOSMAS         | AGGELOS          | JUNIOR KUMITE MALE -68 KG                |
| GRE2220  | Male   | KOSMAS         | AGGELOS          | JUNIOR KUMITE TEAM MALE                  |
| GRE02397   | Male   | KOUKOUSSELIS   | IOANNIS          | Junior Kata Male                         |
| GRE02397   | Male   | KOUKOUSSELIS   | IOANNIS          | Junior Kata Male R2-G2                   |
| GRE02397   | Male   | KOUKOUSSELIS   | IOANNIS          | Junior Kata Male R3 Bronze Medal Match 1 |
| GRE02450   | Male   | KOULOURIS      | DIMITRIOS        | U21 KUMITE MALE -60 KG                   |
| GRE02450   | Male   | KOULOURIS      | DIMITRIOS        | Kumite Team male U21                     |
| GRE02718   | Male   | KOUTALIARIS    | DIMOSTHENIS      | Cadet Kata Male                          |
| GRE02718   | Male   | KOUTALIARIS    | DIMOSTHENIS      | CADET KUMITE MALE -63 KG                 |
| GRE02718   | Male   | KOUTALIARIS    | DIMOSTHENIS      | CADET KUMITE TEAM MALE                   |
| GRE02364   | Male   | LITOS          | FILIPPOS MARIOS  | CADET KUMITE MALE -70 KG                 |
| GRE02312   | Male   | MARKESINIS     | LAMPRINOS MARIOS | U21 Kata Male                            |
| GRE02312   | Male   | MARKESINIS     | LAMPRINOS MARIOS | Kumite Team male U21                     |
| GRE02734   | Male   | MOKAS          | EVANGELOS        | JUNIOR KUMITE MALE -68 KG                |
| GRE02734   | Male   | MOKAS          | EVANGELOS        | JUNIOR KUMITE TEAM MALE                  |
| GRE2183  | Male   | MORAITIS       | NIKOLAOS         | CADET KUMITE MALE -70 KG                 |
| GRE02840   | Male   | MYTILIOS       | KONSTANTINOS     | JUNIOR KUMITE MALE -68 KG                |
| GRE02840   | Male   | MYTILIOS       | KONSTANTINOS     | JUNIOR KUMITE TEAM MALE                  |
| GRE02629   | Male   | PAPADOPOULOS   | GEORGIOS         | CADET KUMITE MALE -52 KG                 |
| GRE02629   | Male   | PAPADOPOULOS   | GEORGIOS         | CADET KUMITE TEAM MALE                   |
| GRE2223  | Male   | PAPPAS         | VASILEIOS        | CADET KUMITE MALE -57 KG                 |
| GRE2223  | Male   | PAPPAS         | VASILEIOS        | CADET KUMITE TEAM MALE                   |
| GRE02458   | Male   | PERGANTHS      | EKTORAS          | CADET KUMITE MALE 70+ KG                 |
| GRE02300   | Male   | PSOMAS         | ILIAS            | CADET KUMITE MALE -70 KG                 |
| GRE02300   | Male   | PSOMAS         | ILIAS            | CADET KUMITE TEAM MALE                   |
| GRE2168  | Male   | STEFANIDIS     | PETROS           | CADET KUMITE MALE 70+ KG                 |
| GRE2168  | Male   | STEFANIDIS     | PETROS           | CADET KUMITE TEAM MALE                   |
| GRE02731   | Male   | SVETSAS        | DIMITRIOS        | JUNIOR KUMITE MALE -55 KG                |
| GRE02835   | Male   | TSEMPELIS      | ODYSSEAS         | JUNIOR KUMITE MALE -61 KG                |



# 21st Balkan Karate Championships for Cadets, J ..

CROATIA  
RIJEKA

2021.11.26 - 2021.11.28

## ENTRY LIST

|          |        |             |                    |   |
|----------|--------|-------------|--------------------|---|
| GRE02835 | Male   | TSEMPELIS   | ODYSSEAS           | JUNIOR KUMITE TEAM MALE                                   |
| GRE02494 | Male   | TSIAKMAKIS  | FOTIOS             | Junior Kata Male  |
| GRE02494 | Male   | TSIAKMAKIS  | FOTIOS             | Junior Kata Male R2-G1                                    |
| GRE02494 | Male   | TSIAKMAKIS  | FOTIOS             | Junior Kata Male R3 Gold Medal Match                      |
| GRE02314 | Male   | VAZAIOS     | SPYRIDONAS         | JUNIOR KUMITE MALE -61 KG                                 |
| GRE02831 | Female | ANASTASIOU  | MARIA GEORGIA      | CADET KUMITE FEMALE 54+ KG                                |
| GRE02831 | Female | ANASTASIOU  | MARIA GEORGIA      | CADET KUMITE TEAM FEMALE                                  |
| GRE02634 | Female | DELIMICHALI | CHRISTINA          | JUNIOR KUMITE FEMALE -59 KG                               |
| GRE02449 | Female | FARMAKI     | KASSIANI           | JUNIOR KUMITE FEMALE -59 KG                               |
| GRE02449 | Female | FARMAKI     | KASSIANI           | JUNIOR KUMITE TEAM FEMALE                                 |
| GRE02307 | Female | FRAGKOULI   | XRISOULA VAGIA     | U21 KUMITE FEMALE 68+ KG                                  |
| GRE02307 | Female | FRAGKOULI   | XRISOULA VAGIA     | Kumite Team female U21                                    |
| GRE02834 | Female | GEORGOULEA  | MYRTO              | JUNIOR KUMITE FEMALE -48 KG                               |
| GRE2178  | Female | IOSIF       | EVA                | JUNIOR KUMITE FEMALE 59+ KG                               |
| GRE2178  | Female | IOSIF       | EVA                | JUNIOR KUMITE TEAM FEMALE                                 |
| GRE02325 | Female | KARAVA      | MARIA-EVANGELIA    | JUNIOR KUMITE FEMALE -59 KG                               |
| GRE02838 | Female | KOKKOTA     | ANASTASIA          | Junior Kata Female  |
| GRE02725 | Female | KONDYLI     | IOANNA             | JUNIOR KUMITE FEMALE 59+ KG                               |
| GRE783   | Female | KOULOURIDOU | PANAGIOTA          | U21 KUMITE FEMALE -55 KG                                  |
| GRE783   | Female | KOULOURIDOU | PANAGIOTA          | U21 Kata Female   |
| GRE783   | Female | KOULOURIDOU | PANAGIOTA          | Kumite Team female U21                                    |
| GRE2259  | Female | KOUTALIARI  | KIRIAKI MARIA      | U21 KUMITE FEMALE -61 KG                                  |
| GRE2259  | Female | KOUTALIARI  | KIRIAKI MARIA      | Kumite Team female U21                                    |
| GRE565   | Female | KYDONAKI    | KYRIAKI            | U21 KUMITE FEMALE 68+ KG                                  |
| GRE02837 | Female | LAOUDI      | IOANNA             | CADET KUMITE FEMALE -47 KG                                |
| GRE2219  | Female | LYRITSI     | VASILIKI           | JUNIOR KUMITE FEMALE -53 KG                               |
| GRE2219  | Female | LYRITSI     | VASILIKI           | JUNIOR KUMITE TEAM FEMALE                                 |
| GRE744   | Female | MOYSIDOU    | ANTONIA            | U21 Kata Female   |
| GRE02326 | Female | ORAIPOULOU  | STAVROULA          | U21 KUMITE FEMALE -68 KG                                  |
| GRE02326 | Female | ORAIPOULOU  | STAVROULA          | Kumite Team female U21                                    |
| GRE02642 | Female | PAPPA       | CHRISTINA TRIADA   | CADET KUMITE FEMALE -47 KG                                |
| GRE02642 | Female | PAPPA       | CHRISTINA TRIADA   | KATA TEAM CADET AND JUNIOR FEMALE                         |
| GRE02642 | Female | PAPPA       | CHRISTINA TRIADA   | CADET KUMITE TEAM FEMALE                                  |
| GRE02642 | Female | PAPPA       | CHRISTINA TRIADA   | KATA TEAM CADET AND JUNIOR FEMALE R2 Bronze Medal Match 2 |
| GRE02641 | Female | PAVLITINA   | MARIA              | CADET KUMITE FEMALE 54+ KG                                |
| GRE02641 | Female | PAVLITINA   | MARIA              | KATA TEAM CADET AND JUNIOR FEMALE                         |
| GRE02641 | Female | PAVLITINA   | MARIA              | CADET KUMITE TEAM FEMALE                                  |
| GRE02641 | Female | PAVLITINA   | MARIA              | KATA TEAM CADET AND JUNIOR FEMALE R2 Bronze Medal Match 2 |
| GRE02716 | Female | PLATA       | KYRIAKI            | JUNIOR KUMITE FEMALE -53 KG                               |
| GRE02632 | Female | REGKLI      | THEONI             | Cadet Kata Female   |
| GRE02632 | Female | REGKLI      | THEONI             | CADET KUMITE FEMALE -47 KG                                |
| GRE2152  | Female | SIETI       | ANGELIKA PARASKEVI | JUNIOR KUMITE FEMALE -59 KG                               |
| GRE2167  | Female | STEFANIDOU  | CHRYSOULA          | JUNIOR KUMITE FEMALE 59+ KG                               |
| GRE02322 | Female | TSAGKERA    | SOFIA              | U21 Kata Female   |
| GRE02322 | Female | TSAGKERA    | SOFIA              | U21 Kata Female R2-G1                                     |
| GRE02322 | Female | TSAGKERA    | SOFIA              | U21 Kata Female R3 Bronze Medal Match 1                   |
| GRE02495 | Female | TSIAKMAKI   | ATHINA             | Cadet Kata Female   |
| GRE02495 | Female | TSIAKMAKI   | ATHINA             | Cadet Kata Female R2-G1                                   |

## 21st Balkan Karate Championships for Cadets, J ..

CROATIA  
RIJEKA

2021.11.26 - 2021.11.28

### ENTRY LIST

|          |        |               |                |   |
|----------|--------|---------------|----------------|---|
| GRE02495 | Female | TSIAKMAKI     | ATHINA         | Cadet Kata Female R3 Bronze Medal Match 2                 |
| GRE02444 | Female | TSILINGERIDOU | ELENI          | JUNIOR KUMITE FEMALE 59+ KG                               |
| GRE02316 | Female | TZILIA        | STYLIANI-ELENI | JUNIOR KUMITE FEMALE -53 KG                               |
| GRE02316 | Female | TZILIA        | STYLIANI-ELENI | JUNIOR KUMITE TEAM FEMALE                                 |
| GRE02713 | Female | VASILEIADI    | MELINA         | CADET KUMITE FEMALE -47 KG                                |
| GRE02320 | Female | XENOU         | LYDIA LAMPRINI | CADET KUMITE FEMALE -54 KG                                |
| GRE02320 | Female | XENOU         | LYDIA LAMPRINI | KATA TEAM CADET AND JUNIOR FEMALE                         |
| GRE02320 | Female | XENOU         | LYDIA LAMPRINI | CADET KUMITE TEAM FEMALE                                  |
| GRE02320 | Female | XENOU         | LYDIA LAMPRINI | KATA TEAM CADET AND JUNIOR FEMALE R2 Bronze Medal Match 2 |
| GRE02836 | Female | XORIANOPOULOU | MARIA          | CADET KUMITE FEMALE 54+ KG                                |

Entries: **105**



# 21st Balkan Karate Championships for Cadets, J ..

CROATIA  
RIJEKA

2021.11.26 - 2021.11.28

## ENTRY LIST

| KOS - KOSOVO |        |             |            |                           |
|--------------|--------|-------------|------------|---------------------------|
| ID           | Gender | Family Name | Given Name | Event                     |
| KOS02860     | Male   | ADEMI       | OLT        | CADET KUMITE MALE -70 KG  |
| KOS02860     | Male   | ADEMI       | OLT        | CADET KUMITE TEAM MALE    |
| KOS02540     | Male   | BAJRAMI     | SEFER      | JUNIOR KUMITE MALE -76 KG |
| KOS02540     | Male   | BAJRAMI     | SEFER      | JUNIOR KUMITE TEAM MALE   |
| KOS2209      | Male   | BEKA        | ENDRIT     | U21 KUMITE MALE -67 KG    |
| KOS2209      | Male   | BEKA        | ENDRIT     | Kumite Team male U21      |
| KOS02857     | Male   | BERISHA     | ARIAN      | JUNIOR KUMITE MALE -68 KG |
| KOS02857     | Male   | BERISHA     | ARIAN      | JUNIOR KUMITE TEAM MALE   |
| KOS02727     | Male   | DEMIRI      | LUAN       | JUNIOR KUMITE MALE -61 KG |
| KOS02727     | Male   | DEMIRI      | LUAN       | JUNIOR KUMITE TEAM MALE   |
| KOS02553     | Male   | GASHI       | DREN       | CADET KUMITE MALE -57 KG  |
| KOS02553     | Male   | GASHI       | DREN       | CADET KUMITE TEAM MALE    |
| KOS02608     | Male   | GASHI       | LEART      | CADET KUMITE MALE 70+ KG  |
| KOS02608     | Male   | GASHI       | LEART      | Cadet Kata Male           |
| KOS02608     | Male   | GASHI       | LEART      | CADET KUMITE TEAM MALE    |
| KOS2036      | Male   | GASHI       | MELOS      | U21 KUMITE MALE -84 KG    |
| KOS2036      | Male   | GASHI       | MELOS      | Kumite Team male U21      |
| KOS02779     | Male   | HALILOSMANI | NORIK      | Junior Kata Male          |
| KOS02779     | Male   | HALILOSMANI | NORIK      | JUNIOR KUMITE MALE 76+ KG |
| KOS2343      | Male   | HALIMI      | QENDRIM    | JUNIOR KUMITE MALE -61 KG |
| KOS2343      | Male   | HALIMI      | QENDRIM    | JUNIOR KUMITE TEAM MALE   |
| KOS02859     | Male   | HASANAJ     | LORIK      | CADET KUMITE MALE -57 KG  |
| KOS02859     | Male   | HASANAJ     | LORIK      | CADET KUMITE TEAM MALE    |
| KOS2359      | Male   | IBRAHIMI    | DREN       | JUNIOR KUMITE MALE -61 KG |
| KOS2359      | Male   | IBRAHIMI    | DREN       | JUNIOR KUMITE TEAM MALE   |
| KOS02782     | Male   | ISMAJLI     | GONI       | JUNIOR KUMITE MALE -68 KG |
| KOS02782     | Male   | ISMAJLI     | GONI       | JUNIOR KUMITE TEAM MALE   |
| KOS2378      | Male   | MALIQI      | BETIM      | U21 KUMITE MALE -75 KG    |
| KOS2378      | Male   | MALIQI      | BETIM      | Kumite Team male U21      |
| KOS02776     | Male   | MALOKU      | ORGES      | CADET KUMITE MALE -70 KG  |
| KOS02776     | Male   | MALOKU      | ORGES      | CADET KUMITE TEAM MALE    |
| KOS2050      | Male   | MEROVCI     | ALBIN      | U21 KUMITE MALE -67 KG    |
| KOS2050      | Male   | MEROVCI     | ALBIN      | Kumite Team male U21      |
| KOS2358      | Male   | MUSLIU      | ELTON      | U21 KUMITE MALE 84+ KG    |
| KOS02732     | Male   | POROSHTICA  | MAL        | U21 KUMITE MALE -67 KG    |
| KOS2361      | Male   | RASHITI     | LUNDRIT    | U21 Kata Male             |
| KOS2380      | Male   | REXHEPI     | MIRLIND    | U21 KUMITE MALE -84 KG    |
| KOS2380      | Male   | REXHEPI     | MIRLIND    | Kumite Team male U21      |
| KOS2190      | Male   | SAHITI      | JUSUF      | JUNIOR KUMITE MALE 76+ KG |
| KOS2190      | Male   | SAHITI      | JUSUF      | JUNIOR KUMITE TEAM MALE   |
| KOS2061      | Male   | SELMANAJ    | ARLIND     | U21 KUMITE MALE -67 KG    |
| KOS2067      | Male   | SELMANI     | ALBINOT    | U21 KUMITE MALE -60 KG    |
| KOS2067      | Male   | SELMANI     | ALBINOT    | Kumite Team male U21      |
| KOS2192      | Male   | SHAQIRI     | ARTIOL     | CADET KUMITE MALE -63 KG  |
| KOS2192      | Male   | SHAQIRI     | ARTIOL     | CADET KUMITE TEAM MALE    |
| KOS2375      | Male   | SHAQIRI     | ENDRIT     | U21 KUMITE MALE 84+ KG    |
| KOS2375      | Male   | SHAQIRI     | ENDRIT     | Kumite Team male U21      |

# 21st Balkan Karate Championships for Cadets, J ..

CROATIA  
RIJEKA

2021.11.26 - 2021.11.28

## ENTRY LIST

|          |        |            |          |                             |
|----------|--------|------------|----------|-----------------------------|
| KOS02545 | Female | ARIFI      | ENKELA   | Junior Kata Female          |
| KOS02544 | Female | BUDAKOVA   | ANTONETA | U21 Kata Female             |
| KOS02544 | Female | BUDAKOVA   | ANTONETA | U21 KUMITE FEMALE -55 KG    |
| KOS2377  | Female | CURRI      | FESTINA  | U21 KUMITE FEMALE -68 KG    |
| KOS2377  | Female | CURRI      | FESTINA  | Kumite Team female U21      |
| KOS02542 | Female | EMERLLAHU  | RONA     | JUNIOR KUMITE FEMALE 59+ KG |
| KOS2348  | Female | FONIQI     | ANILA    | JUNIOR KUMITE FEMALE -53 KG |
| KOS2348  | Female | FONIQI     | ANILA    | JUNIOR KUMITE TEAM FEMALE   |
| KOS2251  | Female | GASHI      | REDONA   | U21 KUMITE FEMALE -50 KG    |
| KOS2251  | Female | GASHI      | REDONA   | Kumite Team female U21      |
| KOS2252  | Female | GASHI      | VALEZA   | JUNIOR KUMITE FEMALE 59+ KG |
| KOS2252  | Female | GASHI      | VALEZA   | JUNIOR KUMITE TEAM FEMALE   |
| KOS02856 | Female | GASHI      | ELMEDINA | JUNIOR KUMITE FEMALE -59 KG |
| KOS02858 | Female | HASANAJ    | DEA      | CADET KUMITE FEMALE -47 KG  |
| KOS2187  | Female | IBRAHIMI   | QENDRESA | CADET KUMITE FEMALE -54 KG  |
| KOS2187  | Female | IBRAHIMI   | QENDRESA | CADET KUMITE TEAM FEMALE    |
| KOS2353  | Female | KRASNIQI   | DIOLA    | JUNIOR KUMITE FEMALE -53 KG |
| KOS02733 | Female | KURSHUMLIU | ORGESA   | JUNIOR KUMITE FEMALE 59+ KG |
| KOS2125  | Female | LOKI       | ALMA     | Junior Kata Female          |
| KOS2125  | Female | LOKI       | ALMA     | JUNIOR KUMITE FEMALE -53 KG |
| KOS2387  | Female | MAHALLA    | DIELLZA  | CADET KUMITE FEMALE 54+ KG  |
| KOS2387  | Female | MAHALLA    | DIELLZA  | CADET KUMITE TEAM FEMALE    |
| KOS2185  | Female | MUSTAFA    | BEHIJE   | JUNIOR KUMITE FEMALE 59+ KG |
| KOS2185  | Female | MUSTAFA    | BEHIJE   | JUNIOR KUMITE TEAM FEMALE   |
| KOS2249  | Female | OSMANI     | NJOMZA   | U21 KUMITE FEMALE 68+ KG    |
| KOS2249  | Female | OSMANI     | NJOMZA   | Kumite Team female U21      |
| KOS2250  | Female | OSMANI     | RINESA   | JUNIOR KUMITE FEMALE -59 KG |
| KOS2250  | Female | OSMANI     | RINESA   | JUNIOR KUMITE TEAM FEMALE   |
| KOS2057  | Female | QERIMI     | VLERA    | U21 KUMITE FEMALE -68 KG    |
| KOS2057  | Female | QERIMI     | VLERA    | Kumite Team female U21      |
| KOS02778 | Female | SEJDIU     | LORINDA  | CADET KUMITE FEMALE 54+ KG  |
| KOS02778 | Female | SEJDIU     | LORINDA  | CADET KUMITE TEAM FEMALE    |
| KOS2384  | Female | SHABANI    | DENISA   | CADET KUMITE FEMALE -54 KG  |
| KOS2186  | Female | SOPIJANI   | ERBLINA  | CADET KUMITE FEMALE 54+ KG  |
| KOS2186  | Female | SOPIJANI   | ERBLINA  | CADET KUMITE TEAM FEMALE    |
| KOS2055  | Female | ZEJNULLAHU | HATIGJE  | U21 KUMITE FEMALE -50 KG    |

Entries: 83

# 21st Balkan Karate Championships for Cadets, J ..

CROATIA  
RIJEKA

2021.11.26 - 2021.11.28

## ENTRY LIST

| MNE - MONTENEGRO |        |             |            |   |
|------------------|--------|-------------|------------|---|
| ID               | Gender | Family Name | Given Name | Event   |
| MNE02925         | Male   | ABRAMOVIC   | VASO       | CADET KUMITE MALE 70+ KG                                |
| MNE2141          | Male   | BAKIC       | FILIP      | U21 Kata Male   |
| MNE2141          | Male   | BAKIC       | FILIP      | U21 Kata Male R2-G2                                     |
| MNE2141          | Male   | BAKIC       | FILIP      | U21 Kata Male R3 Gold Medal Match                       |
| MNE2198          | Male   | BIJELIC     | DUSAN      | JUNIOR KUMITE MALE 76+ KG                               |
| MNE2050          | Male   | BOJIC       | MATIJA     | U21 KUMITE MALE -60 KG                                  |
| MNE2169          | Male   | BOSKOVIC    | FILIP      | JUNIOR KUMITE MALE 76+ KG                               |
| MNE02788         | Male   | CALIC       | UROS       | CADET KUMITE MALE 70+ KG                                |
| MNE2272          | Male   | DJURCEVIC   | LAZAR      | CADET KUMITE MALE -63 KG                                |
| MNE2273          | Male   | DJURETIC    | ALIMPIJE   | CADET KUMITE MALE -70 KG                                |
| MNE2463          | Male   | DJURICIC    | NENAD      | CADET KUMITE MALE -63 KG                                |
| MNE02785         | Male   | DZOGANOVIC  | ALEKSANDAR | CADET KUMITE MALE 70+ KG                                |
| MNE2457          | Male   | GERSCHWITZ  | AJSEL      | Cadet Kata Male   |
| MNE2457          | Male   | GERSCHWITZ  | AJSEL      | KATA TEAM CADET AND JUNIOR MALE                         |
| MNE2457          | Male   | GERSCHWITZ  | AJSEL      | KATA TEAM CADET AND JUNIOR MALE R2 Bronze Medal Match 1 |
| MNE2266          | Male   | JANJIC      | ALEKSA     | Cadet Kata Male   |
| MNE2266          | Male   | JANJIC      | ALEKSA     | KATA TEAM CADET AND JUNIOR MALE                         |
| MNE2266          | Male   | JANJIC      | ALEKSA     | KATA TEAM CADET AND JUNIOR MALE R2 Bronze Medal Match 1 |
| MNE2287          | Male   | JOVOVIC     | LAZAR      | JUNIOR KUMITE MALE -76 KG                               |
| MNE2192          | Male   | JOVOVIC     | NEMANJA    | U21 KUMITE MALE 84+ KG                                  |
| MNE2078          | Male   | KOCAN       | ARIJAN     | U21 Kata Male   |
| MNE2078          | Male   | KOCAN       | ARIJAN     | U21 Kata Male R2-G1                                     |
| MNE2078          | Male   | KOCAN       | ARIJAN     | U21 Kata Male R3 Bronze Medal Match 2                   |
| MNE2285          | Male   | MADZAROVIC  | LAZAR      | JUNIOR KUMITE MALE -68 KG                               |
| MNE02827         | Male   | MIJANOVIC   | FILIP      | U21 KUMITE MALE -75 KG                                  |
| MNE2076          | Male   | MILICKOVIC  | BALSA      | U21 KUMITE MALE -75 KG                                  |
| MNE2136          | Male   | MILIC       | NIKOLA     | Junior Kata Male  |
| MNE2136          | Male   | MILIC       | NIKOLA     | KATA TEAM CADET AND JUNIOR MALE                         |
| MNE2136          | Male   | MILIC       | NIKOLA     | KATA TEAM CADET AND JUNIOR MALE R2 Bronze Medal Match 1 |
| MNE2142          | Male   | NIKOCEVIC   | KENAN      | U21 Kata Male   |
| MNE2142          | Male   | NIKOCEVIC   | KENAN      | U21 Kata Male R2-G1                                     |
| MNE2142          | Male   | NIKOCEVIC   | KENAN      | U21 Kata Male R3 Gold Medal Match                       |
| MNE2186          | Male   | POTPARA     | LAZAR      | JUNIOR KUMITE MALE 76+ KG                               |
| MNE02789         | Male   | ROGANOVIC   | MILOS      | CADET KUMITE MALE -63 KG                                |
| MNE02644         | Male   | SALJIU      | EMRE       | JUNIOR KUMITE MALE -68 KG                               |
| MNE2369          | Male   | SEKULIC     | LAZAR      | Junior Kata Male  |
| MNE02926         | Male   | SKATARIC    | LAZAR      | CADET KUMITE MALE -57 KG                                |
| MNE2277          | Male   | VOJINOVIC   | BALSA      | CADET KUMITE MALE -52 KG                                |
| MNE02829         | Female | ALIVODIC    | DINA       | CADET KUMITE FEMALE -54 KG                              |
| MNE2293          | Female | BACKOVIC    | HELENA     | CADET KUMITE FEMALE -47 KG                              |
| MNE02682         | Female | CALIC       | JOVANA     | JUNIOR KUMITE FEMALE -59 KG                             |
| MNE2173          | Female | CANOVIC     | DZENA      | U21 Kata Female   |
| MNE2173          | Female | CANOVIC     | DZENA      | Kata Team female U21                                    |
| MNE2290          | Female | DAMJANOVIC  | JOVANA     | CADET KUMITE FEMALE -54 KG                              |
| MNE390           | Female | DJUKANOVIC  | MASA       | U21 Kata Female   |

## 21st Balkan Karate Championships for Cadets, J ..

CROATIA  
RIJEKA

2021.11.26 - 2021.11.28

### ENTRY LIST

|          |        |             |         |                             |
|----------|--------|-------------|---------|-----------------------------|
| MNE390   | Female | DJUKANOVIC  | MASA    | Kata Team female U21        |
| MNE397   | Female | JOVANOVIC   | MILENA  | U21 KUMITE FEMALE 68+ KG    |
| MNE2258  | Female | KOCAN       | ARIJANA | Cadet Kata Female           |
| MNE2292  | Female | KOTLAJA     | JOVANA  | CADET KUMITE FEMALE 54+ KG  |
| MNE2094  | Female | MARKIC      | LEONA   | JUNIOR KUMITE FEMALE -59 KG |
| MNE2177  | Female | MARKOVIC    | MILA    | Junior Kata Female          |
| MNE2177  | Female | MARKOVIC    | MILA    | Junior Kata Female R2-G1    |
| MNE2130  | Female | MRAKOVIC    | MILA    | U21 Kata Female             |
| MNE2130  | Female | MRAKOVIC    | MILA    | U21 Kata Female R2-G1       |
| MNE2130  | Female | MRAKOVIC    | MILA    | Kata Team female U21        |
| MNE02790 | Female | PAPOVIC     | MILJANA | CADET KUMITE FEMALE 54+ KG  |
| MNE02828 | Female | RADOVANOVIC | DANICA  | Junior Kata Female          |
| MNE02828 | Female | RADOVANOVIC | DANICA  | JUNIOR KUMITE FEMALE -53 KG |
| MNE2095  | Female | STOJANOVIC  | JOVANA  | JUNIOR KUMITE FEMALE 59+ KG |
| MNE2107  | Female | STRUJIC     | JOVANA  | U21 KUMITE FEMALE -55 KG    |
| MNE2257  | Female | ZHRANE      | MARIAM  | CADET KUMITE FEMALE 54+ KG  |

Entries: **61**

# 21st Balkan Karate Championships for Cadets, J ..

CROATIA  
RIJEKA

2021.11.26 - 2021.11.28

## ENTRY LIST

|  MKD - NORTH MACEDONIA |        |                |            |   |
|--|--------|----------------|------------|---|
| ID   | Gender | Family Name    | Given Name | Event   |
| MKD02743   | Male   | ANDRIC         | HRISTIJAN  | Junior Kata Male                                    |
| MKD02743   | Male   | ANDRIC         | HRISTIJAN  | KATA TEAM CADET AND JUNIOR MALE                     |
| MKD02743   | Male   | ANDRIC         | HRISTIJAN  | KATA TEAM CADET AND JUNIOR MALE R2 Gold Medal Match |
| MKD2252  | Male   | ANGELOVSKI     | ANDREJ     | JUNIOR KUMITE MALE -76 KG                           |
| MKD2252  | Male   | ANGELOVSKI     | ANDREJ     | JUNIOR KUMITE TEAM MALE                             |
| MKD2113  | Male   | BAJRAMI        | ILIR       | U21 KUMITE MALE -75 KG                              |
| MKD2113  | Male   | BAJRAMI        | ILIR       | Kumite Team male U21                                |
| MKD2433  | Male   | BASAROV        | ANDREJ     | CADET KUMITE MALE 70+ KG                            |
| MKD2433  | Male   | BASAROV        | ANDREJ     | CADET KUMITE TEAM MALE                              |
| MKD2418  | Male   | BELISTOJANOSKI | MATEJ      | JUNIOR KUMITE MALE -55 KG                           |
| MKD2418  | Male   | BELISTOJANOSKI | MATEJ      | JUNIOR KUMITE TEAM MALE                             |
| MKD2390  | Male   | DIMCHEVSKI     | MARIO      | CADET KUMITE MALE -52 KG                            |
| MKD2390  | Male   | DIMCHEVSKI     | MARIO      | Cadet Kata Male                                     |
| MKD2390  | Male   | DIMCHEVSKI     | MARIO      | CADET KUMITE TEAM MALE                              |
| MKD2160  | Male   | DZAMGJOZOV     | BOBAN      | U21 KUMITE MALE -84 KG                              |
| MKD2160  | Male   | DZAMGJOZOV     | BOBAN      | Kumite Team male U21                                |
| MKD396   | Male   | IDRIZ          | ABDURAHIM  | U21 KUMITE MALE -60 KG                              |
| MKD396   | Male   | IDRIZ          | ABDURAHIM  | Kumite Team male U21                                |
| MKD2443  | Male   | JOVANOVIH      | VUKASHIN   | CADET KUMITE MALE -63 KG                            |
| MKD2443  | Male   | JOVANOVIH      | VUKASHIN   | CADET KUMITE TEAM MALE                              |
| MKD2253  | Male   | KOSTOV         | BOJAN      | U21 KUMITE MALE -60 KG                              |
| MKD02744   | Male   | KURTANOVIC     | BERIZ      | U21 KUMITE MALE 84+ KG                              |
| MKD02744   | Male   | KURTANOVIC     | BERIZ      | Kumite Team male U21                                |
| MKD2423  | Male   | LOZANOSKI      | DIMITAR    | JUNIOR KUMITE MALE -68 KG                           |
| MKD02889   | Male   | MEMETI         | BESART     | CADET KUMITE MALE -52 KG                            |
| MKD02889   | Male   | MEMETI         | BESART     | CADET KUMITE TEAM MALE                              |
| MKD2290  | Male   | MIHAJLOV       | LJUPCHE    | JUNIOR KUMITE MALE -68 KG                           |
| MKD2290  | Male   | MIHAJLOV       | LJUPCHE    | JUNIOR KUMITE TEAM MALE                             |
| MKD02745   | Male   | MUSLIJI        | OMER       | U21 KUMITE MALE -67 KG                              |
| MKD465   | Male   | NEDELKOVSKI    | ALEKSANDAR | U21 Kata Male                                       |
| MKD465   | Male   | NEDELKOVSKI    | ALEKSANDAR | U21 Kata Male R2-G1                                 |
| MKD465   | Male   | NEDELKOVSKI    | ALEKSANDAR | U21 Kata Male R3 Bronze Medal Match 1               |
| MKD2257  | Male   | OSMANI         | JASIN      | JUNIOR KUMITE MALE 76+ KG                           |
| MKD2294  | Male   | PESHKOV        | ANDREJ     | Junior Kata Male                                    |
| MKD515   | Male   | PETKOV         | GLIGOR     | U21 KUMITE MALE -84 KG                              |
| MKD515   | Male   | PETKOV         | GLIGOR     | Kumite Team male U21                                |
| MKD2426  | Male   | PETRESKI       | SIMON      | JUNIOR KUMITE MALE -76 KG                           |
| MKD2426  | Male   | PETRESKI       | SIMON      | JUNIOR KUMITE TEAM MALE                             |
| MKD2636  | Male   | PETRESKI       | STEFAN     | JUNIOR KUMITE MALE -61 KG                           |
| MKD2389  | Male   | POPTODOROV     | MARKO      | Cadet Kata Male                                     |
| MKD2389  | Male   | POPTODOROV     | MARKO      | Cadet Kata Male R2-G2                               |
| MKD2389  | Male   | POPTODOROV     | MARKO      | Cadet Kata Male R3 Bronze Medal Match 2             |
| MKD02688   | Male   | RAMADANI       | AZIZ       | CADET KUMITE MALE -52 KG                            |
| MKD02688   | Male   | RAMADANI       | AZIZ       | CADET KUMITE TEAM MALE                              |
| MKD02892   | Male   | REDJEP         | RUSHTI     | CADET KUMITE MALE -63 KG                            |
| MKD02888   | Male   | RIGON          | ADEMI      | CADET KUMITE MALE -52 KG                            |

# 21st Balkan Karate Championships for Cadets, J ..

CROATIA  
RIJEKA

2021.11.26 - 2021.11.28

## ENTRY LIST

|          |        |              |            |   |
|----------|--------|--------------|------------|---|
| MKD02894 | Male   | RUSHITI      | REDZEP     | CADET KUMITE TEAM MALE                              |
| MKD2566  | Male   | SHAQIRI      | NEDIM      | JUNIOR KUMITE MALE -61 KG                           |
| MKD2588  | Male   | SPASOV       | VIKTOR     | CADET KUMITE MALE -63 KG                            |
| MKD2588  | Male   | SPASOV       | VIKTOR     | CADET KUMITE TEAM MALE                              |
| MKD2067  | Male   | SPASOVSKI    | DAVID      | Junior Kata Male                                    |
| MKD2067  | Male   | SPASOVSKI    | DAVID      | KATA TEAM CADET AND JUNIOR MALE                     |
| MKD2067  | Male   | SPASOVSKI    | DAVID      | KATA TEAM CADET AND JUNIOR MALE R2 Gold Medal Match |
| MKD02895 | Male   | STOJANCEVSKI | ALEKSANDAR | Junior Kata Male                                    |
| MKD2402  | Male   | STOJANOSKI   | ANDREJ     | KATA TEAM CADET AND JUNIOR MALE                     |
| MKD2402  | Male   | STOJANOSKI   | ANDREJ     | KATA TEAM CADET AND JUNIOR MALE R2 Gold Medal Match |
| MKD2637  | Male   | STOJANOVIKJ  | STEFAN     | U21 KUMITE MALE 84+ KG                              |
| MKD2637  | Male   | STOJANOVIKJ  | STEFAN     | Kumite Team male U21                                |
| MKD527   | Male   | SVINARSKI    | MARIO      | U21 KUMITE MALE -75 KG                              |
| MKD527   | Male   | SVINARSKI    | MARIO      | Kumite Team male U21                                |
| MKD02891 | Male   | TASEVSKI     | DARIJAN    | U21 KUMITE MALE 84+ KG                              |
| MKD2153  | Male   | TRAJKOVSKI   | VITOMIR    | JUNIOR KUMITE MALE -76 KG                           |
| MKD2153  | Male   | TRAJKOVSKI   | VITOMIR    | JUNIOR KUMITE TEAM MALE                             |
| MKD2289  | Male   | ZYLALI       | HAMZA      | JUNIOR KUMITE MALE 76+ KG                           |
| MKD2289  | Male   | ZYLALI       | HAMZA      | JUNIOR KUMITE TEAM MALE                             |
| MKD02887 | Male   | BILJALI      | ILI        | JUNIOR KUMITE MALE -61 KG                           |
| MKD02887 | Male   | BILJALI      | ILI        | JUNIOR KUMITE TEAM MALE                             |
| MKD2094  | Female | ADEMI        | JUSRA      | JUNIOR KUMITE FEMALE 59+ KG                         |
| MKD2094  | Female | ADEMI        | JUSRA      | JUNIOR KUMITE TEAM FEMALE                           |
| MKD2109  | Female | ALIU         | RUDINA     | JUNIOR KUMITE FEMALE -53 KG                         |
| MKD2109  | Female | ALIU         | RUDINA     | JUNIOR KUMITE TEAM FEMALE                           |
| MKD02893 | Female | ARSOVA       | DJESIKA    | JUNIOR KUMITE FEMALE 59+ KG                         |
| MKD2096  | Female | ARSOVSKA     | MARTINA    | Junior Kata Female                                  |
| MKD2096  | Female | ARSOVSKA     | MARTINA    | Junior Kata Female R2-G1                            |
| MKD2103  | Female | BOZHINOVSKA  | MAGDALENA  | U21 KUMITE FEMALE -61 KG                            |
| MKD2103  | Female | BOZHINOVSKA  | MAGDALENA  | Kumite Team female U21                              |
| MKD2258  | Female | BUSHI        | ARTA       | JUNIOR KUMITE FEMALE -59 KG                         |
| MKD2258  | Female | BUSHI        | ARTA       | JUNIOR KUMITE TEAM FEMALE                           |
| MKD02896 | Female | DAVIDOVSKA   | ANGELA     | JUNIOR KUMITE FEMALE -48 KG                         |
| MKD2556  | Female | DUKA         | SARA       | CADET KUMITE FEMALE -54 KG                          |
| MKD2556  | Female | DUKA         | SARA       | CADET KUMITE TEAM FEMALE                            |
| MKD02890 | Female | ILIEVSKA     | IVANA      | U21 KUMITE FEMALE -55 KG                            |
| MKD02890 | Female | ILIEVSKA     | IVANA      | Kumite Team female U21                              |
| MKD2076  | Female | JANCHOVSKA   | KAROLINA   | U21 Kata Female                                     |
| MKD476   | Female | JOVANOVSKA   | VIKTORIJA  | U21 KUMITE FEMALE -61 KG                            |
| MKD476   | Female | JOVANOVSKA   | VIKTORIJA  | Kumite Team female U21                              |
| MKD2557  | Female | KOXHA        | ERA        | JUNIOR KUMITE FEMALE -59 KG                         |
| MKD2070  | Female | MANCHEVSKA   | JOVANA     | U21 Kata Female                                     |
| MKD2395  | Female | MINGOVSKA    | ANASTASIJA | Cadet Kata Female                                   |
| MKD2395  | Female | MINGOVSKA    | ANASTASIJA | Cadet Kata Female R2-G2                             |
| MKD2406  | Female | MISHOVSKA    | MIHAELA    | JUNIOR KUMITE FEMALE -53 KG                         |
| MKD2406  | Female | MISHOVSKA    | MIHAELA    | JUNIOR KUMITE TEAM FEMALE                           |
| MKD2405  | Female | MUSTAFAI     | GRESA      | CADET KUMITE FEMALE 54+ KG                          |
| MKD2405  | Female | MUSTAFAI     | GRESA      | CADET KUMITE TEAM FEMALE                            |

## 21st Balkan Karate Championships for Cadets, J ..

CROATIA  
RIJEKA

2021.11.26 - 2021.11.28

### ENTRY LIST

|         |        |           |         |   |
|---------|--------|-----------|---------|---|
| MKD2403 | Female | PECEVSKA  | IVA     | JUNIOR KUMITE FEMALE -48 KG               |
| MKD517  | Female | PETROVSKA | MARIJA  | U21 KUMITE FEMALE -50 KG                  |
| MKD2288 | Female | RAMO      | LORIANA | U21 KUMITE FEMALE -61 KG                  |
| MKD2288 | Female | RAMO      | LORIANA | Kumite Team female U21                    |
| MKD2558 | Female | SELA      | GENTA   | JUNIOR KUMITE FEMALE -59 KG               |
| MKD2387 | Female | STOJKOVA  | DANKA   | Cadet Kata Female                         |
| MKD2387 | Female | STOJKOVA  | DANKA   | Cadet Kata Female R2-G1                   |
| MKD2387 | Female | STOJKOVA  | DANKA   | Cadet Kata Female R3 Bronze Medal Match 1 |

Entries: **102**



# 21st Balkan Karate Championships for Cadets, J ..

CROATIA  
RIJEKA

2021.11.26 - 2021.11.28

## ENTRY LIST

|  <b>ROU - ROMANIA</b> |        |             |                   |  |
|---|--------|-------------|-------------------|--|
| ID  | Gender | Family Name | Given Name        | Event                                    |
| ROU02985  | Male   | BUDAN PIRVU | PATRICK ALEX      | Cadet Kata Male                          |
| ROU02985  | Male   | BUDAN PIRVU | PATRICK ALEX      | CADET KUMITE MALE -63 KG                 |
| ROU02720  | Male   | CARBUNEANU  | RADU              | CADET KUMITE MALE -63 KG                 |
| ROU02720  | Male   | CARBUNEANU  | RADU              | CADET KUMITE TEAM MALE                   |
| ROU02830  | Male   | DOGARU      | ALEXANDRU IONUT   | JUNIOR KUMITE MALE -55 KG                |
| ROU02830  | Male   | DOGARU      | ALEXANDRU IONUT   | JUNIOR KUMITE TEAM MALE                  |
| ROU03093  | Male   | DRAGAN      | MIHAI-ROBERT      | CADET KUMITE MALE -57 KG                 |
| ROU03093  | Male   | DRAGAN      | MIHAI-ROBERT      | CADET KUMITE TEAM MALE                   |
| ROU2575   | Male   | DRAGULIN    | ALFONSO ANDREI    | CADET KUMITE MALE -52 KG                 |
| ROU2575   | Male   | DRAGULIN    | ALFONSO ANDREI    | CADET KUMITE TEAM MALE                   |
| ROU02716  | Male   | GEORGESCU   | THEODOR PETRU     | CADET KUMITE MALE -70 KG                 |
| ROU02716  | Male   | GEORGESCU   | THEODOR PETRU     | CADET KUMITE TEAM MALE                   |
| ROU2371   | Male   | GRIGORIU    | STEFAN ANTON      | Junior Kata Male                         |
| ROU2371   | Male   | GRIGORIU    | STEFAN ANTON      | JUNIOR KUMITE MALE -68 KG                |
| ROU2371   | Male   | GRIGORIU    | STEFAN ANTON      | JUNIOR KUMITE TEAM MALE                  |
| ROU03094  | Male   | MARIN       | MARIAN            | JUNIOR KUMITE MALE -68 KG                |
| ROU03094  | Male   | MARIN       | MARIAN            | JUNIOR KUMITE TEAM MALE                  |
| ROU03100  | Male   | MERDA       | ROBERT            | U21 Kata Male                            |
| ROU2382   | Male   | MIHALACHE   | MIHAI             | U21 KUMITE MALE -67 KG                   |
| ROU03099  | Male   | MOCANU      | VLADUT PAUL       | JUNIOR KUMITE MALE 76+ KG                |
| ROU03099  | Male   | MOCANU      | VLADUT PAUL       | JUNIOR KUMITE TEAM MALE                  |
| ROU2463   | Male   | MOISE       | LEONARD           | JUNIOR KUMITE MALE 76+ KG                |
| ROU2463   | Male   | MOISE       | LEONARD           | JUNIOR KUMITE TEAM MALE                  |
| ROU03091  | Male   | MOLDOVAN    | DAVIDE ALESSANDRO | CADET KUMITE MALE -63 KG                 |
| ROU03091  | Male   | MOLDOVAN    | DAVIDE ALESSANDRO | CADET KUMITE TEAM MALE                   |
| ROU2466   | Male   | MUNTEANU    | MIHAI ALEXANDRU   | CADET KUMITE MALE -70 KG                 |
| ROU2466   | Male   | MUNTEANU    | MIHAI ALEXANDRU   | CADET KUMITE TEAM MALE                   |
| ROU2259   | Male   | NEDELCU     | ANDREI GABRIEL    | U21 Kata Male                            |
| ROU2490   | Male   | POPESCU     | STEFAN OCTAVIAN   | JUNIOR KUMITE MALE -68 KG                |
| ROU02717  | Male   | SPITA       | DANTES            | CADET KUMITE MALE -63 KG                 |
| ROU02717  | Male   | SPITA       | DANTES            | CADET KUMITE TEAM MALE                   |
| ROU2183   | Male   | TORNACI     | ERHAN             | JUNIOR KUMITE MALE -61 KG                |
| ROU2183   | Male   | TORNACI     | ERHAN             | JUNIOR KUMITE TEAM MALE                  |
| ROU2487   | Male   | TUDOR       | DANIEL            | JUNIOR KUMITE MALE -68 KG                |
| ROU2487   | Male   | TUDOR       | DANIEL            | JUNIOR KUMITE TEAM MALE                  |
| ROU2293   | Male   | VULPOIU     | EDUARD            | Junior Kata Male                         |
| ROU2293   | Male   | VULPOIU     | EDUARD            | Junior Kata Male R2-G2                   |
| ROU2293   | Male   | VULPOIU     | EDUARD            | Junior Kata Male R3 Bronze Medal Match 2 |
| ROU03097  | Female | ADOCHITEI   | MARIA             | CADET KUMITE FEMALE 54+ KG               |
| ROU03097  | Female | ADOCHITEI   | MARIA             | CADET KUMITE TEAM FEMALE                 |
| ROU03098  | Female | ANDREI      | LORELLEY          | JUNIOR KUMITE FEMALE -53 KG              |
| ROU03098  | Female | ANDREI      | LORELLEY          | JUNIOR KUMITE TEAM FEMALE                |
| ROU03101  | Female | BACIU       | MARIA             | Cadet Kata Female                        |
| ROU02981  | Female | BANEASU     | MICHELLE          | Junior Kata Female                       |
| ROU2185   | Female | COMAN       | MARIA CRISTINA    | JUNIOR KUMITE FEMALE 59+ KG              |



# 21st Balkan Karate Championships for Cadets, J ..

CROATIA  
RIJEKA

2021.11.26 - 2021.11.28

## ENTRY LIST

|          |        |           |                        |                             |
|----------|--------|-----------|------------------------|-----------------------------|
| ROU2185  | Female | COMAN     | MARIA CRISTINA         | JUNIOR KUMITE TEAM FEMALE   |
| ROU03096 | Female | COFIL     | FRANCESCA              | Cadet Kata Female           |
| ROU03096 | Female | COFIL     | FRANCESCA              | CADET KUMITE FEMALE 54+ KG  |
| ROU2484  | Female | COSTANZO  | ISABELLA JOANA         | Junior Kata Female          |
| ROU2484  | Female | COSTANZO  | ISABELLA JOANA         | Junior Kata Female R2-G2    |
| ROU2484  | Female | COSTANZO  | ISABELLA JOANA         | Junior Kata Female R3-G2    |
| ROU03092 | Female | CRUCERU   | ALESSIA                | CADET KUMITE FEMALE -47 KG  |
| ROU03092 | Female | CRUCERU   | ALESSIA                | CADET KUMITE TEAM FEMALE    |
| ROU2568  | Female | HUIU      | STEFANIA<br>ALECSANDRA | CADET KUMITE FEMALE 54+ KG  |
| ROU03095 | Female | IVASCU    | LARISA ADRIANA         | CADET KUMITE FEMALE -54 KG  |
| ROU03095 | Female | IVASCU    | LARISA ADRIANA         | CADET KUMITE TEAM FEMALE    |
| ROU2461  | Female | MANICA    | BRIANA                 | JUNIOR KUMITE FEMALE -59 KG |
| ROU2461  | Female | MANICA    | BRIANA                 | JUNIOR KUMITE TEAM FEMALE   |
| ROU02988 | Female | MARGINEAN | SARRA                  | JUNIOR KUMITE FEMALE -48 KG |
| ROU02988 | Female | MARGINEAN | SARRA                  | JUNIOR KUMITE TEAM FEMALE   |
| ROU2569  | Female | NASTAS    | PATRICIA               | CADET KUMITE FEMALE -47 KG  |
| ROU2569  | Female | NASTAS    | PATRICIA               | Cadet Kata Female           |
| ROU2569  | Female | NASTAS    | PATRICIA               | CADET KUMITE TEAM FEMALE    |
| ROU2375  | Female | PAVEL     | LIVIA                  | U21 KUMITE FEMALE -68 KG    |
| ROU2584  | Female | POPESCU   | MARIA ANASTASIA        | U21 Kata Female             |

Entries: **65**

# 21st Balkan Karate Championships for Cadets, J ..

CROATIA  
RIJEKA

2021.11.26 - 2021.11.28

## ENTRY LIST

|  <b>SRB - SERBIA</b> |        |             |            |   |
|--|--------|-------------|------------|---|
| ID   | Gender | Family Name | Given Name | Event   |
| SRB2733  | Male   | ANDJELIC    | PETAR      | JUNIOR KUMITE MALE -76 KG                               |
| SRB2516  | Male   | BLANUSA     | MARKO      | CADET KUMITE MALE -63 KG                                |
| SRB2516  | Male   | BLANUSA     | MARKO      | CADET KUMITE TEAM MALE                                  |
| SRB03074   | Male   | BOGDANOVIC  | DAMIR      | CADET KUMITE MALE -57 KG                                |
| SRB2536  | Male   | BOSKOV      | ALEKSANDAR | Cadet Kata Male   |
| SRB2536  | Male   | BOSKOV      | ALEKSANDAR | KATA TEAM CADET AND JUNIOR MALE                         |
| SRB2536  | Male   | BOSKOV      | ALEKSANDAR | KATA TEAM CADET AND JUNIOR MALE R2 Bronze Medal Match 2 |
| SRB2133  | Male   | BULAJIC     | VUKAN      | JUNIOR KUMITE MALE 76+ KG                               |
| SRB2534  | Male   | CUBRILO     | LUKA       | JUNIOR KUMITE MALE -68 KG                               |
| SRB2534  | Male   | CUBRILO     | LUKA       | JUNIOR KUMITE TEAM MALE                                 |
| SRB2737  | Male   | CUMBO       | NIKOLA     | JUNIOR KUMITE MALE -55 KG                               |
| SRB2320  | Male   | CVETKOVIC   | MILUTIN    | JUNIOR KUMITE MALE -61 KG                               |
| SRB03258   | Male   | DJOKIC      | ANDRIJA    | Junior Kata Male R2-G1                                  |
| SRB03258   | Male   | DJOKIC      | ANDRIJA    | Junior Kata Male  |
| SRB03258   | Male   | DJOKIC      | ANDRIJA    | Junior Kata Male R3 Bronze Medal Match 1                |
| SRB03272   | Male   | DJORDJEVIC  | STRAHINJA  | U21 Kata Male   |
| SRB03559   | Male   | DJURDJIC    | MARKO      | CADET KUMITE MALE -52 KG                                |
| SRB03570   | Male   | DUGONJIC    | UROS       | Cadet Kata Male   |
| SRB03570   | Male   | DUGONJIC    | UROS       | Cadet Kata Male R2-G2                                   |
| SRB03570   | Male   | DUGONJIC    | UROS       | Cadet Kata Male R3 Gold Medal Match                     |
| SRB2808  | Male   | GAVRILOVIC  | SRDJAN     | CADET KUMITE MALE 70+ KG                                |
| SRB03263   | Male   | GIRIC       | LUKA       | JUNIOR KUMITE MALE -76 KG                               |
| SRB03263   | Male   | GIRIC       | LUKA       | JUNIOR KUMITE TEAM MALE                                 |
| SRB03582   | Male   | GNJIDIC     | MARKO      | CADET KUMITE MALE -70 KG                                |
| SRB03582   | Male   | GNJIDIC     | MARKO      | CADET KUMITE TEAM MALE                                  |
| SRB2512  | Male   | GRUBIC      | DJORDJE    | CADET KUMITE MALE -63 KG                                |
| SRB2512  | Male   | GRUBIC      | DJORDJE    | CADET KUMITE TEAM MALE                                  |
| SRB2323  | Male   | GRUBIC      | MIHAJLO    | JUNIOR KUMITE MALE -76 KG                               |
| SRB2323  | Male   | GRUBIC      | MIHAJLO    | JUNIOR KUMITE TEAM MALE                                 |
| SRB2410  | Male   | IVANOVIC    | NIKOLA     | U21 KUMITE MALE -75 KG                                  |
| SRB2410  | Male   | IVANOVIC    | NIKOLA     | Kumite Team male U21                                    |
| SRB2456  | Male   | JELOVAC     | DUSAN      | U21 KUMITE MALE 84+ KG                                  |
| SRB2571  | Male   | KNEZEVIC    | PAVLE      | JUNIOR KUMITE MALE -68 KG                               |
| SRB2517  | Male   | KOLAROV     | ZARKO      | JUNIOR KUMITE MALE -55 KG                               |
| SRB474   | Male   | KOVACEVIC   | PAVLE      | U21 KUMITE MALE -67 KG                                  |
| SRB474   | Male   | KOVACEVIC   | PAVLE      | Kumite Team male U21                                    |
| SRB2725  | Male   | KRNAJAC     | MIHAJLO    | CADET KUMITE MALE -52 KG                                |
| SRB2533  | Male   | KRNJAJAC    | MILOS      | CADET KUMITE MALE -70 KG                                |
| SRB03259   | Male   | LUCIC       | FILIP      | JUNIOR KUMITE MALE -61 KG                               |
| SRB2498  | Male   | MARKOVIC    | MIHAJLO    | JUNIOR KUMITE MALE -68 KG                               |
| SRB2631  | Male   | MASLAK      | NIKOLA     | U21 KUMITE MALE -84 KG                                  |
| SRB2631  | Male   | MASLAK      | NIKOLA     | Kumite Team male U21                                    |
| SRB03059   | Male   | MIJANOVIC   | RASTKO     | CADET KUMITE MALE 70+ KG                                |
| SRB03059   | Male   | MIJANOVIC   | RASTKO     | CADET KUMITE TEAM MALE                                  |
| SRB2541  | Male   | MILOSEVIC   | ILIJA      | CADET KUMITE MALE 70+ KG                                |
| SRB2541  | Male   | MILOSEVIC   | ILIJA      | CADET KUMITE TEAM MALE                                  |

# 21st Balkan Karate Championships for Cadets, J ..

CROATIA  
RIJEKA

2021.11.26 - 2021.11.28

## ENTRY LIST

|          |        |               |            |   |
|----------|--------|---------------|------------|---|
| SRB2542  | Male   | MILUNOVIC     | STEFAN     | CADET KUMITE MALE -63 KG                                |
| SRB03254 | Male   | MILUTINOVIC   | MILOS      | U21 KUMITE MALE -67 KG                                  |
| SRB03254 | Male   | MILUTINOVIC   | MILOS      | Kumite Team male U21                                    |
| SRB2574  | Male   | NIKOLIC       | DIMITRIJE  | Cadet Kata Male   |
| SRB2574  | Male   | NIKOLIC       | DIMITRIJE  | Cadet Kata Male R2-G1                                   |
| SRB2574  | Male   | NIKOLIC       | DIMITRIJE  | Cadet Kata Male R3 Gold Medal Match                     |
| SRB2574  | Male   | NIKOLIC       | DIMITRIJE  | KATA TEAM CADET AND JUNIOR MALE                         |
| SRB2574  | Male   | NIKOLIC       | DIMITRIJE  | KATA TEAM CADET AND JUNIOR MALE R2 Bronze Medal Match 2 |
| SRB02996 | Male   | NOVAKOVIC     | STRAHINJA  | CADET KUMITE MALE -57 KG                                |
| SRB2261  | Male   | ORLANDIC      | PETAR      | JUNIOR KUMITE MALE -68 KG                               |
| SRB2261  | Male   | ORLANDIC      | PETAR      | JUNIOR KUMITE TEAM MALE                                 |
| SRB2522  | Male   | PAVLOVIC      | STEFAN     | Junior Kata Male  |
| SRB2522  | Male   | PAVLOVIC      | STEFAN     | KATA TEAM CADET AND JUNIOR MALE                         |
| SRB2522  | Male   | PAVLOVIC      | STEFAN     | KATA TEAM CADET AND JUNIOR MALE R2 Bronze Medal Match 2 |
| SRB2494  | Male   | PEJOVIC       | UGLJESA    | JUNIOR KUMITE MALE 76+ KG                               |
| SRB2494  | Male   | PEJOVIC       | UGLJESA    | JUNIOR KUMITE TEAM MALE                                 |
| SRB389   | Male   | POPOVIC       | MIHAJLO    | U21 KUMITE MALE -75 KG                                  |
| SRB389   | Male   | POPOVIC       | MIHAJLO    | Kumite Team male U21                                    |
| SRB03583 | Male   | PUCAR         | MARKO      | JUNIOR KUMITE MALE -61 KG                               |
| SRB2472  | Male   | PURIC         | LAZAR      | CADET KUMITE MALE -57 KG                                |
| SRB2472  | Male   | PURIC         | LAZAR      | CADET KUMITE TEAM MALE                                  |
| SRB2311  | Male   | PURIC         | MILOS      | Junior Kata Male  |
| SRB2311  | Male   | PURIC         | MILOS      | Junior Kata Male R2-G2                                  |
| SRB2474  | Male   | RADISAVLJEVIC | JOVAN      | Cadet Kata Male   |
| SRB2474  | Male   | RADISAVLJEVIC | JOVAN      | Cadet Kata Male R2-G2                                   |
| SRB2474  | Male   | RADISAVLJEVIC | JOVAN      | Cadet Kata Male R3 Bronze Medal Match 1                 |
| SRB2511  | Male   | RADOJCIN      | DJORDJE    | CADET KUMITE MALE 70+ KG                                |
| SRB2511  | Male   | RADOJCIN      | DJORDJE    | CADET KUMITE TEAM MALE                                  |
| SRB511   | Male   | RISTIC        | DIMITRIJE  | U21 Kata Male   |
| SRB03567 | Male   | SEJDIJA       | DEJAN      | JUNIOR KUMITE MALE -55 KG                               |
| SRB2293  | Male   | STANOJEVIC    | STEFAN     | U21 KUMITE MALE -60 KG                                  |
| SRB2293  | Male   | STANOJEVIC    | STEFAN     | Kumite Team male U21                                    |
| SRB524   | Male   | SUBOTA        | UROS       | U21 Kata Male   |
| SRB524   | Male   | SUBOTA        | UROS       | U21 Kata Male R2-G2                                     |
| SRB524   | Male   | SUBOTA        | UROS       | U21 Kata Male R3 Bronze Medal Match 2                   |
| SRB03571 | Male   | TASIC         | NEMANJA    | CADET KUMITE MALE -70 KG                                |
| SRB03264 | Male   | TOPUZOVIC     | ALEKSANDAR | U21 KUMITE MALE -67 KG                                  |
| SRB03264 | Male   | TOPUZOVIC     | ALEKSANDAR | Kumite Team male U21                                    |
| SRB2401  | Male   | VASILIC       | MIHAJLO    | JUNIOR KUMITE MALE 76+ KG                               |
| SRB2401  | Male   | VASILIC       | MIHAJLO    | JUNIOR KUMITE TEAM MALE                                 |
| SRB03564 | Male   | VIRIJEVIC     | FILIP      | CADET KUMITE MALE -63 KG                                |
| SRB03007 | Male   | VUCKOVIC      | ALEKSANDAR | CADET KUMITE MALE -57 KG                                |
| SRB03101 | Male   | VUKASINOVIC   | MARKO      | CADET KUMITE MALE -52 KG                                |
| SRB2037  | Male   | ZDESIC        | ALEKSANDAR | U21 Kata Male   |
| SRB2037  | Male   | ZDESIC        | ALEKSANDAR | U21 Kata Male R2-G1                                     |
| SRB2664  | Male   | ZIVKOVIC      | OGNJEN     | JUNIOR KUMITE MALE -76 KG                               |
| SRB2664  | Male   | ZIVKOVIC      | OGNJEN     | JUNIOR KUMITE TEAM MALE                                 |
| SRB2268  | Female | BARAC         | JANA       | JUNIOR KUMITE FEMALE -59 KG                             |

# 21st Balkan Karate Championships for Cadets, J ..

CROATIA  
RIJEKA

2021.11.26 - 2021.11.28

## ENTRY LIST

|          |        |             |            |   |
|----------|--------|-------------|------------|---|
| SRB03249 | Female | BOJIC       | MARIJA     | U21 KUMITE FEMALE -50 KG                              |
| SRB03247 | Female | BOTA        | DIJANA     | JUNIOR KUMITE FEMALE 59+ KG                           |
| SRB03247 | Female | BOTA        | DIJANA     | JUNIOR KUMITE TEAM FEMALE                             |
| SRB2135  | Female | CRNOVCIC    | SLAVICA    | U21 Kata Female                                       |
| SRB2135  | Female | CRNOVCIC    | SLAVICA    | U21 Kata Female R2-G2                                 |
| SRB2135  | Female | CRNOVCIC    | SLAVICA    | U21 Kata Female R3 Bronze Medal Match 1               |
| SRB2135  | Female | CRNOVCIC    | SLAVICA    | Kata Team female U21                                  |
| SRB2817  | Female | DJORDJEVIC  | KRISTINA   | JUNIOR KUMITE FEMALE -59 KG                           |
| SRB03010 | Female | DRAGOVIC    | PAOLA      | CADET KUMITE FEMALE -54 KG                            |
| SRB03010 | Female | DRAGOVIC    | PAOLA      | CADET KUMITE TEAM FEMALE                              |
| SRB2340  | Female | FILIPOV     | NEVENA     | JUNIOR KUMITE FEMALE 59+ KG                           |
| SRB2340  | Female | FILIPOV     | NEVENA     | JUNIOR KUMITE TEAM FEMALE                             |
| SRB03067 | Female | GRBIC       | GORDANA    | Cadet Kata Female                                     |
| SRB03067 | Female | GRBIC       | GORDANA    | KATA TEAM CADET AND JUNIOR FEMALE                     |
| SRB03067 | Female | GRBIC       | GORDANA    | KATA TEAM CADET AND JUNIOR FEMALE R2 Gold Medal Match |
| SRB2141  | Female | GRCAK       | JANA       | JUNIOR KUMITE FEMALE 59+ KG                           |
| SRB2141  | Female | GRCAK       | JANA       | JUNIOR KUMITE TEAM FEMALE                             |
| SRB2891  | Female | GRCIC       | TAMARA     | U21 KUMITE FEMALE -50 KG                              |
| SRB2478  | Female | IVANOVIC    | ANDJELA    | JUNIOR KUMITE FEMALE -59 KG                           |
| SRB2478  | Female | IVANOVIC    | ANDJELA    | JUNIOR KUMITE TEAM FEMALE                             |
| SRB2142  | Female | JANKOVIC    | BOJANA     | U21 KUMITE FEMALE -55 KG                              |
| SRB2142  | Female | JANKOVIC    | BOJANA     | Kumite Team female U21                                |
| SRB03581 | Female | JEVTOVIC    | DUNJA      | CADET KUMITE FEMALE 54+ KG                            |
| SRB03565 | Female | JOKSIMOVIC  | DJURDJA    | CADET KUMITE FEMALE -54 KG                            |
| SRB03566 | Female | JOKSIMOVIC  | MARTA      | CADET KUMITE FEMALE -54 KG                            |
| SRB2674  | Female | JOVANOVIC   | KRSTINA    | Junior Kata Female                                    |
| SRB2674  | Female | JOVANOVIC   | KRSTINA    | Junior Kata Female R2-G2                              |
| SRB2473  | Female | JOVANOVIC   | SAVA       | Cadet Kata Female                                     |
| SRB2473  | Female | JOVANOVIC   | SAVA       | Cadet Kata Female R2-G2                               |
| SRB2473  | Female | JOVANOVIC   | SAVA       | Cadet Kata Female R3 Bronze Medal Match 2             |
| SRB2473  | Female | JOVANOVIC   | SAVA       | KATA TEAM CADET AND JUNIOR FEMALE                     |
| SRB2473  | Female | JOVANOVIC   | SAVA       | KATA TEAM CADET AND JUNIOR FEMALE R2 Gold Medal Match |
| SRB03076 | Female | JOVOVIC     | DUNJA      | CADET KUMITE FEMALE -47 KG                            |
| SRB03214 | Female | KALAJDZIC   | SARA       | JUNIOR KUMITE FEMALE -53 KG                           |
| SRB03576 | Female | KRSTIC      | KATARINA   | CADET KUMITE FEMALE -47 KG                            |
| SRB2303  | Female | LAZAREVSKI  | MINA       | Junior Kata Female                                    |
| SRB2303  | Female | LAZAREVSKI  | MINA       | Junior Kata Female R2-G1                              |
| SRB2515  | Female | MARTINOVIC  | ALEKSANDRA | JUNIOR KUMITE FEMALE -53 KG                           |
| SRB2310  | Female | MESIC       | MINA       | U21 Kata Female                                       |
| SRB2310  | Female | MESIC       | MINA       | Kata Team female U21                                  |
| SRB2287  | Female | MILIC       | MASA       | JUNIOR KUMITE FEMALE -53 KG                           |
| SRB03033 | Female | MILOSEVIC   | NEDA       | Cadet Kata Female                                     |
| SRB03033 | Female | MILOSEVIC   | NEDA       | Cadet Kata Female R2-G1                               |
| SRB03033 | Female | MILOSEVIC   | NEDA       | Cadet Kata Female R3 Gold Medal Match                 |
| SRB03033 | Female | MILOSEVIC   | NEDA       | KATA TEAM CADET AND JUNIOR FEMALE                     |
| SRB03033 | Female | MILOSEVIC   | NEDA       | KATA TEAM CADET AND JUNIOR FEMALE R2 Gold Medal Match |
| SRB03568 | Female | MILOSEVIC   | TEODORA    | U21 KUMITE FEMALE 68+ KG                              |
| SRB2557  | Female | MILUTINOVIC | ALEKSANDRA | JUNIOR KUMITE FEMALE -59 KG                           |

# 21st Balkan Karate Championships for Cadets, J ..

CROATIA  
RIJEKA

2021.11.26 - 2021.11.28

## ENTRY LIST

|          |        |             |            |                             |
|----------|--------|-------------|------------|-----------------------------|
| SRB2138  | Female | NEGOVANOVIC | BRANKICA   | U21 KUMITE FEMALE -55 KG    |
| SRB2489  | Female | NIJEMCEVIC  | ANA        | CADET KUMITE FEMALE 54+ KG  |
| SRB2489  | Female | NIJEMCEVIC  | ANA        | CADET KUMITE TEAM FEMALE    |
| SRB03563 | Female | NIKOLIC     | MILICA     | Junior Kata Female          |
| SRB2136  | Female | NIKOLIC     | MILICA     | U21 Kata Female             |
| SRB2136  | Female | NIKOLIC     | MILICA     | Kata Team female U21        |
| SRB03578 | Female | PAUCINAC    | HANA       | U21 KUMITE FEMALE -50 KG    |
| SRB2704  | Female | PAVIC       | JELENA     | U21 Kata Female             |
| SRB496   | Female | PEROVIC     | IVANA      | U21 KUMITE FEMALE 68+ KG    |
| SRB496   | Female | PEROVIC     | IVANA      | Kumite Team female U21      |
| SRB2480  | Female | RADOVANOVIC | ALEKSANDRA | Junior Kata Female          |
| SRB2349  | Female | RADOVIC     | ANJA       | U21 KUMITE FEMALE -68 KG    |
| SRB2349  | Female | RADOVIC     | ANJA       | Kumite Team female U21      |
| SRB2507  | Female | RAJIC       | DUNJA      | CADET KUMITE FEMALE 54+ KG  |
| SRB2507  | Female | RAJIC       | DUNJA      | CADET KUMITE TEAM FEMALE    |
| SRB03054 | Female | RAUKOVIC    | ANDJELA    | CADET KUMITE FEMALE -54 KG  |
| SRB03054 | Female | RAUKOVIC    | ANDJELA    | CADET KUMITE TEAM FEMALE    |
| SRB2816  | Female | ROGIC       | ALEKSANDRA | CADET KUMITE FEMALE 54+ KG  |
| SRB03256 | Female | SERATLIC    | NATALIJA   | U21 KUMITE FEMALE -55 KG    |
| SRB2487  | Female | SIMIC       | KATARINA   | CADET KUMITE FEMALE -47 KG  |
| SRB2106  | Female | SMILJANIC   | BOJANA     | JUNIOR KUMITE FEMALE 59+ KG |
| SRB2363  | Female | SPASIC      | IVANA      | U21 KUMITE FEMALE -61 KG    |
| SRB03579 | Female | TRIFUNOVIC  | TIJANA     | U21 KUMITE FEMALE -55 KG    |
| SRB2312  | Female | TRIKOS      | MINA       | U21 KUMITE FEMALE -61 KG    |
| SRB2103  | Female | TRMCIC      | LIDIJA     | JUNIOR KUMITE FEMALE -53 KG |
| SRB370   | Female | VARSAKOVIC  | MINJA      | U21 KUMITE FEMALE 68+ KG    |
| SRB2407  | Female | ZIVKOVIC    | TAMARA     | U21 KUMITE FEMALE -61 KG    |
| SRB2407  | Female | ZIVKOVIC    | TAMARA     | Kumite Team female U21      |

Entries: **170**

# 21st Balkan Karate Championships for Cadets, J ..

CROATIA  
RIJEKA

2021.11.26 - 2021.11.28

## ENTRY LIST

|  <b>SLO - SLOVENIA</b> |        |             |            |  |
|--|--------|-------------|------------|--|
| ID   | Gender | Family Name | Given Name | Event                                    |
| SLO02638   | Male   | BARL        | MAJ        | JUNIOR KUMITE MALE -76 KG                |
| SLO2273  | Male   | BOROVNIK    | NIK        | CADET KUMITE MALE -70 KG                 |
| SLO2273  | Male   | BOROVNIK    | NIK        | CADET KUMITE TEAM MALE                   |
| SLO02684   | Male   | CRNCEC      | ANEL       | JUNIOR KUMITE MALE -68 KG                |
| SLO02684   | Male   | CRNCEC      | ANEL       | JUNIOR KUMITE TEAM MALE                  |
| SLO2365  | Male   | GAAL        | JAKA       | U21 KUMITE MALE -75 KG                   |
| SLO2365  | Male   | GAAL        | JAKA       | Kumite Team male U21                     |
| SLO2363  | Male   | GORISEK     | MATEJ      | U21 KUMITE MALE -75 KG                   |
| SLO2363  | Male   | GORISEK     | MATEJ      | Kumite Team male U21                     |
| SLO2086  | Male   | HUDALES     | TOMAZ      | U21 KUMITE MALE -67 KG                   |
| SLO2086  | Male   | HUDALES     | TOMAZ      | Kumite Team male U21                     |
| SLO2215  | Male   | ISAKOVIC    | KENAN      | JUNIOR KUMITE MALE -68 KG                |
| SLO2215  | Male   | ISAKOVIC    | KENAN      | JUNIOR KUMITE TEAM MALE                  |
| SLO2213  | Male   | JORDAN      | TIMOTEJ    | JUNIOR KUMITE MALE -76 KG                |
| SLO2213  | Male   | JORDAN      | TIMOTEJ    | JUNIOR KUMITE TEAM MALE                  |
| SLO2355  | Male   | KLOBASA     | ALEKS      | U21 KUMITE MALE -84 KG                   |
| SLO2355  | Male   | KLOBASA     | ALEKS      | Kumite Team male U21                     |
| SLO2079  | Male   | KLOBASA     | BLAZ       | U21 Kata Male                            |
| SLO2417  | Male   | KRZISNIK    | GAL        | JUNIOR KUMITE MALE 76+ KG                |
| SLO2417  | Male   | KRZISNIK    | GAL        | JUNIOR KUMITE TEAM MALE                  |
| SLO2216  | Male   | MARKULJEVIC | MARKO      | JUNIOR KUMITE MALE -76 KG                |
| SLO2217  | Male   | MARKULJEVIC | UROS       | JUNIOR KUMITE MALE 76+ KG                |
| SLO2217  | Male   | MARKULJEVIC | UROS       | JUNIOR KUMITE TEAM MALE                  |
| SLO2351  | Male   | MOCNIK      | TIMI       | Junior Kata Male                         |
| SLO2351  | Male   | MOCNIK      | TIMI       | Junior Kata Male R2-G1                   |
| SLO2351  | Male   | MOCNIK      | TIMI       | Junior Kata Male R3 Bronze Medal Match 1 |
| SLO2351  | Male   | MOCNIK      | TIMI       | Junior Kata Male R3 Bronze Medal Match 2 |
| SLO02688   | Male   | PASIC       | ISAK       | CADET KUMITE MALE -57 KG                 |
| SLO02688   | Male   | PASIC       | ISAK       | CADET KUMITE TEAM MALE                   |
| SLO02758   | Male   | POGACAR     | JAKA       | CADET KUMITE MALE -52 KG                 |
| SLO02758   | Male   | POGACAR     | JAKA       | CADET KUMITE TEAM MALE                   |
| SLO2491  | Male   | RAKOVNIK    | SVEN       | JUNIOR KUMITE MALE -61 KG                |
| SLO2491  | Male   | RAKOVNIK    | SVEN       | JUNIOR KUMITE TEAM MALE                  |
| SLO2350  | Male   | SEHIC       | DENIS      | JUNIOR KUMITE MALE -61 KG                |
| SLO2458  | Male   | SLUGA       | JURE       | Junior Kata Male                         |
| SLO2209  | Male   | STERNISA    | NEJC       | U21 Kata Male                            |
| SLO2209  | Male   | STERNISA    | NEJC       | U21 Kata Male R2-G2                      |
| SLO2209  | Male   | STERNISA    | NEJC       | U21 Kata Male R3 Bronze Medal Match 1    |
| SLO02633   | Male   | SUSA        | ZIGA       | JUNIOR KUMITE MALE -68 KG                |
| SLO02633   | Male   | SUSA        | ZIGA       | JUNIOR KUMITE TEAM MALE                  |
| SLO2204  | Male   | TAMSE       | NIKLAS     | U21 KUMITE MALE -60 KG                   |
| SLO2204  | Male   | TAMSE       | NIKLAS     | Kumite Team male U21                     |
| SLO02560   | Male   | TRATNIK     | ALEN       | CADET KUMITE MALE -52 KG                 |
| SLO02560   | Male   | TRATNIK     | ALEN       | CADET KUMITE TEAM MALE                   |
| SLO2201  | Male   | VALENCAK    | MIHAEL     | U21 KUMITE MALE -60 KG                   |
| SLO2201  | Male   | VALENCAK    | MIHAEL     | Kumite Team male U21                     |
| SLO2427  | Male   | ZARIC       | VID        | JUNIOR KUMITE MALE -61 KG                |



# 21st Balkan Karate Championships for Cadets, J ..

CROATIA  
RIJEKA

2021.11.26 - 2021.11.28

## ENTRY LIST

|          |        |                |            |  |
|----------|--------|----------------|------------|--|
| SLO2443  | Male   | ZIBRET         | BOR        | CADET KUMITE MALE -63 KG                   |
| SLO2443  | Male   | ZIBRET         | BOR        | CADET KUMITE TEAM MALE                     |
| SLO2033  | Male   | ZIDAR          | DOMEN      | U21 KUMITE MALE -67 KG                     |
| SLO2033  | Male   | ZIDAR          | DOMEN      | Kumite Team male U21                       |
| SLO02583 | Male   | ZUMER          | JAKOB      | CADET KUMITE MALE 70+ KG                   |
| SLO02583 | Male   | ZUMER          | JAKOB      | CADET KUMITE TEAM MALE                     |
| SLO2431  | Female | AVZNER         | ZOJA       | JUNIOR KUMITE FEMALE -59 KG                |
| SLO2431  | Female | AVZNER         | ZOJA       | JUNIOR KUMITE TEAM FEMALE                  |
| SLO2457  | Female | BERGANT        | LAURA      | U21 KUMITE FEMALE -55 KG                   |
| SLO02759 | Female | CERU           | JERNEJA    | CADET KUMITE FEMALE 54+ KG                 |
| SLO02759 | Female | CERU           | JERNEJA    | CADET KUMITE TEAM FEMALE                   |
| SLO2095  | Female | CESAR          | PIA        | U21 Kata Female                            |
| SLO2095  | Female | CESAR          | PIA        | U21 Kata Female R2-G2                      |
| SLO2095  | Female | CESAR          | PIA        | U21 Kata Female R3 Bronze Medal Match 2    |
| SLO2361  | Female | DAKOVIC        | LARA       | U21 KUMITE FEMALE -50 KG                   |
| SLO2361  | Female | DAKOVIC        | LARA       | Kumite Team female U21                     |
| SLO2194  | Female | DEBELJAK       | HANA       | U21 KUMITE FEMALE -61 KG                   |
| SLO2194  | Female | DEBELJAK       | HANA       | Kumite Team female U21                     |
| SLO02683 | Female | FAJFER         | LANA       | Junior Kata Female                         |
| SLO2098  | Female | GANZITTI       | NIA        | U21 Kata Female                            |
| SLO2415  | Female | HUMAR          | GAJA       | CADET KUMITE FEMALE 54+ KG                 |
| SLO2415  | Female | HUMAR          | GAJA       | CADET KUMITE TEAM FEMALE                   |
| SLO02565 | Female | JESENEK ROJSEK | ANEJA      | CADET KUMITE FEMALE -54 KG                 |
| SLO02623 | Female | KOBAL PAHOR    | LEA        | Junior Kata Female                         |
| SLO02623 | Female | KOBAL PAHOR    | LEA        | Junior Kata Female R2-G2                   |
| SLO02623 | Female | KOBAL PAHOR    | LEA        | Junior Kata Female R3-G2                   |
| SLO02623 | Female | KOBAL PAHOR    | LEA        | Junior Kata Female R4 Bronze Medal Match 1 |
| SLO02626 | Female | KUTIJA         | ALJA       | Junior Kata Female                         |
| SLO02626 | Female | KUTIJA         | ALJA       | Junior Kata Female R2-G1                   |
| SLO02761 | Female | LAZANSKI       | MAJA       | Cadet Kata Female                          |
| SLO2450  | Female | MAGAJNA        | MASA       | JUNIOR KUMITE FEMALE -48 KG                |
| SLO2450  | Female | MAGAJNA        | MASA       | JUNIOR KUMITE TEAM FEMALE                  |
| SLO2371  | Female | MOLNAR         | ELIZABETA  | U21 KUMITE FEMALE -68 KG                   |
| SLO2371  | Female | MOLNAR         | ELIZABETA  | Kumite Team female U21                     |
| SLO02682 | Female | MUZIK          | TASA       | CADET KUMITE FEMALE 54+ KG                 |
| SLO02682 | Female | MUZIK          | TASA       | CADET KUMITE TEAM FEMALE                   |
| SLO2202  | Female | NADIZAR        | LANA TISA  | Junior Kata Female                         |
| SLO2202  | Female | NADIZAR        | LANA TISA  | Junior Kata Female R2-G1                   |
| SLO2202  | Female | NADIZAR        | LANA TISA  | Junior Kata Female R3-G1                   |
| SLO2202  | Female | NADIZAR        | LANA TISA  | Junior Kata Female R4 Bronze Medal Match 2 |
| SLO02572 | Female | PETKOVIC       | SASA       | CADET KUMITE FEMALE 54+ KG                 |
| SLO02572 | Female | PETKOVIC       | SASA       | CADET KUMITE TEAM FEMALE                   |
| SLO02573 | Female | PETKOVIC       | TJASA      | CADET KUMITE FEMALE -54 KG                 |
| SLO2100  | Female | POTISK         | LAURA      | U21 KUMITE FEMALE -68 KG                   |
| SLO2100  | Female | POTISK         | LAURA      | Kumite Team female U21                     |
| SLO2367  | Female | SENICA         | NIKA       | U21 KUMITE FEMALE -68 KG                   |
| SLO2425  | Female | SEVER          | ANA        | JUNIOR KUMITE FEMALE 59+ KG                |
| SLO2425  | Female | SEVER          | ANA        | JUNIOR KUMITE TEAM FEMALE                  |
| SLO2422  | Female | ZAGER          | HANA       | Cadet Kata Female                          |
| SLO2448  | Female | ZIBRET         | ZALA MARIA | JUNIOR KUMITE FEMALE 59+ KG                |

# 21st Balkan Karate Championships for Cadets, J ..

CROATIA  
RIJEKA

2021.11.26 - 2021.11.28

## ENTRY LIST

|         |        |        |            |                           |
|---------|--------|--------|------------|---------------------------|
| SLO2448 | Female | ZIBRET | ZALA MARIA | JUNIOR KUMITE TEAM FEMALE |
|---------|--------|--------|------------|---------------------------|

Entries: **98**



# 21st Balkan Karate Championships for Cadets, J ..

CROATIA  
RIJEKA

2021.11.26 - 2021.11.28

## ENTRY LIST

|  <b>TUR - TURKEY</b> |        |             |               |   |
|--|--------|-------------|---------------|---|
| ID   | Gender | Family Name | Given Name    | Event   |
| TUR2939  | Male   | AKBABA      | ALI EFE       | Junior Kata Male                                    |
| TUR2939  | Male   | AKBABA      | ALI EFE       | KATA TEAM CADET AND JUNIOR MALE                     |
| TUR2939  | Male   | AKBABA      | ALI EFE       | KATA TEAM CADET AND JUNIOR MALE R2 Gold Medal Match |
| TUR03687   | Male   | AKCA        | SAMIL         | JUNIOR KUMITE MALE -76 KG                           |
| TUR2763  | Male   | AKKURT      | EREN          | U21 KUMITE MALE -75 KG                              |
| TUR2679  | Male   | ASLAN       | GORKEM        | Junior Kata Male                                    |
| TUR2679  | Male   | ASLAN       | GORKEM        | Junior Kata Male R2-G2                              |
| TUR2679  | Male   | ASLAN       | GORKEM        | Junior Kata Male R3 Gold Medal Match                |
| TUR2679  | Male   | ASLAN       | GORKEM        | KATA TEAM CADET AND JUNIOR MALE                     |
| TUR2679  | Male   | ASLAN       | GORKEM        | KATA TEAM CADET AND JUNIOR MALE R2 Gold Medal Match |
| TUR2983  | Male   | AYDEMIR     | SULEYMAN      | CADET KUMITE MALE -70 KG                            |
| TUR03626   | Male   | AYHAN       | SULEYMAN EGE  | CADET KUMITE MALE 70+ KG                            |
| TUR03195   | Male   | BALIKCIOGLU | ABDULKERIM    | U21 KUMITE MALE -84 KG                              |
| TUR2726  | Male   | DUGEROGLU   | EFE           | JUNIOR KUMITE MALE -68 KG                           |
| TUR03624   | Male   | ESER        | BAYRAM ANIL   | CADET KUMITE MALE -57 KG                            |
| TUR2662  | Male   | GENC        | KADIR FURKAN  | U21 KUMITE MALE 84+ KG                              |
| TUR03669   | Male   | GOKCEK      | SEMIH VOLKAN  | CADET KUMITE MALE -52 KG                            |
| TUR2663  | Male   | HALICI      | MERT          | JUNIOR KUMITE MALE -55 KG                           |
| TUR2440  | Male   | KAYNAR      | OMER BERAT    | U21 Kata Male                                       |
| TUR2440  | Male   | KAYNAR      | OMER BERAT    | U21 Kata Male R2-G2                                 |
| TUR03629   | Male   | KILIC       | YUSUF         | Junior Kata Male                                    |
| TUR03629   | Male   | KILIC       | YUSUF         | Junior Kata Male R2-G1                              |
| TUR03629   | Male   | KILIC       | YUSUF         | Junior Kata Male R3 Bronze Medal Match 2            |
| TUR03629   | Male   | KILIC       | YUSUF         | Junior Kata Male R3 Gold Medal Match                |
| TUR03629   | Male   | KILIC       | YUSUF         | KATA TEAM CADET AND JUNIOR MALE                     |
| TUR03629   | Male   | KILIC       | YUSUF         | KATA TEAM CADET AND JUNIOR MALE R2 Gold Medal Match |
| TUR03666   | Male   | KUCUKALTIN  | ALPARSLAN     | Cadet Kata Male                                     |
| TUR03666   | Male   | KUCUKALTIN  | ALPARSLAN     | Cadet Kata Male R2-G2                               |
| TUR675   | Male   | OZDEMIR     | BURAK         | U21 KUMITE MALE -60 KG                              |
| TUR03202   | Male   | SUBASI      | NECIP GOKTURK | U21 KUMITE MALE 84+ KG                              |
| TUR03675   | Male   | TURKMENOGLU | MUHAMMET      | JUNIOR KUMITE MALE -68 KG                           |
| TUR2182  | Male   | YILDIRIM    | HASAN CELAL   | JUNIOR KUMITE MALE -61 KG                           |
| TUR2616  | Male   | YILMAZ      | EKREM ALTUNER | U21 KUMITE MALE -67 KG                              |
| TUR2674  | Male   | YURUR       | OMER FARUK    | U21 KUMITE MALE -75 KG                              |
|  | Female | ASLI        | PEHLIVAN      | Junior Kata Female                                  |
|  | Female | ASLI        | PEHLIVAN      | Junior Kata Female R2-G1                            |
|  | Female | ASLI        | PEHLIVAN      | Junior Kata Female R3-G1                            |
| TUR2237  | Female | AVSAR       | KARYA EYLUL   | JUNIOR KUMITE FEMALE -53 KG                         |
| TUR2702  | Female | AYER        | TURKAN        | JUNIOR KUMITE FEMALE -59 KG                         |
| TUR03520   | Female | BALIK       | HAZEL         | U21 KUMITE FEMALE -50 KG                            |
| TUR03690   | Female | BEYAZIT     | MENSURE       | CADET KUMITE FEMALE -47 KG                          |
| TUR03854   | Female | BUBER       | NURBADE       | U21 KUMITE FEMALE -55 KG                            |
| TUR2858  | Female | COLAK       | KEYDA NUR     | U21 Kata Female                                     |
| TUR2858  | Female | COLAK       | KEYDA NUR     | U21 Kata Female R2-G2                               |
| TUR2858  | Female | COLAK       | KEYDA NUR     | U21 Kata Female R3 Gold Medal Match                 |

# 21st Balkan Karate Championships for Cadets, J ..

CROATIA  
RIJEKA

2021.11.26 - 2021.11.28

## ENTRY LIST

|          |        |          |               |   |
|----------|--------|----------|---------------|---|
| TUR2606  | Female | ESER     | CAGLA         | U21 KUMITE FEMALE -61 KG                              |
| TUR2960  | Female | EVSAN    | ESMA SILA     | Cadet Kata Female                                     |
| TUR2960  | Female | EVSAN    | ESMA SILA     | Cadet Kata Female R2-G2                               |
| TUR2960  | Female | EVSAN    | ESMA SILA     | Cadet Kata Female R3 Gold Medal Match                 |
| TUR03698 | Female | GULPINAR | KEVSER ALEYNA | JUNIOR KUMITE FEMALE -48 KG                           |
| TUR2962  | Female | KALPAKLI | IKLIM SEVVAL  | CADET KUMITE FEMALE 54+ KG                            |
| TUR2193  | Female | KASATURA | HIRA NUR      | U21 KUMITE FEMALE -68 KG                              |
| TUR2953  | Female | KAYACAN  | HATICE SENA   | JUNIOR KUMITE FEMALE -48 KG                           |
| TUR3007  | Female | KILIC    | BUSE          | CADET KUMITE FEMALE -54 KG                            |
| TUR03630 | Female | KOYUNCU  | PERI          | Junior Kata Female                                    |
| TUR03630 | Female | KOYUNCU  | PERI          | Junior Kata Female R2-G2                              |
| TUR03630 | Female | KOYUNCU  | PERI          | Junior Kata Female R3-G2                              |
| TUR03630 | Female | KOYUNCU  | PERI          | Junior Kata Female R4 Bronze Medal Match 2            |
| TUR03630 | Female | KOYUNCU  | PERI          | KATA TEAM CADET AND JUNIOR FEMALE                     |
| TUR03630 | Female | KOYUNCU  | PERI          | KATA TEAM CADET AND JUNIOR FEMALE R2 Gold Medal Match |
| TUR2185  | Female | OZYANCAK | TUGCE ELIF    | U21 Kata Female                                       |
| TUR2185  | Female | OZYANCAK | TUGCE ELIF    | U21 Kata Female R2-G1                                 |
| TUR2185  | Female | OZYANCAK | TUGCE ELIF    | U21 Kata Female R3 Gold Medal Match                   |
| TUR2410  | Female | PEHLIVAN | ASLI BASAK    | KATA TEAM CADET AND JUNIOR FEMALE                     |
| TUR2410  | Female | PEHLIVAN | ASLI BASAK    | KATA TEAM CADET AND JUNIOR FEMALE R2 Gold Medal Match |
| TUR03702 | Female | SAHIN    | IREMNUR       | U21 KUMITE FEMALE -68 KG                              |
| TUR03183 | Female | SENGUL   | HULYANUR      | Junior Kata Female                                    |
| TUR03183 | Female | SENGUL   | HULYANUR      | Junior Kata Female R2-G2                              |
| TUR03183 | Female | SENGUL   | HULYANUR      | Junior Kata Female R3-G2                              |
| TUR03183 | Female | SENGUL   | HULYANUR      | Junior Kata Female R4 Gold Medal Match                |
| TUR2188  | Female | TUREMEN  | DAMLA SU      | Junior Kata Female                                    |
| TUR2188  | Female | TUREMEN  | DAMLA SU      | Junior Kata Female R2-G1                              |
| TUR2188  | Female | TUREMEN  | DAMLA SU      | Junior Kata Female R3-G1                              |
| TUR2188  | Female | TUREMEN  | DAMLA SU      | Junior Kata Female R4 Gold Medal Match                |
| TUR2188  | Female | TUREMEN  | DAMLA SU      | KATA TEAM CADET AND JUNIOR FEMALE                     |
| TUR2188  | Female | TUREMEN  | DAMLA SU      | KATA TEAM CADET AND JUNIOR FEMALE R2 Gold Medal Match |
| TUR2415  | Female | UYGUR    | FATMA         | U21 KUMITE FEMALE 68+ KG                              |

Entries: 77

# 21st Balkan Karate Championships for Cadets, J ..

---

CROATIA  
RIJEKA

2021.11.26 - 2021.11.28

## ENTRY LIST

Total Entries: **1,133**

# 21st Balkan Karate Championships for Cadets, J ..

CROATIA  
RIJEKA

2021.11.26 - 2021.11.28

## Statistics

Participating Countries: 13

Participating Regions: 0

Participating  
Team/Clubs: 13

|              | Competitors | Entries    |
|--------------|-------------|------------|
| Female       | 304         | 342        |
| Male         | 392         | 417        |
| <b>Total</b> | <b>696</b>  | <b>759</b> |

### Entries per Category

|                                   | Entries | Teams |
|-----------------------------------|---------|-------|
| CADET KUMITE FEMALE -47 KG        | 22      | -     |
| CADET KUMITE FEMALE -54 KG        | 25      | -     |
| CADET KUMITE FEMALE 54+ KG        | 33      | -     |
| CADET KUMITE MALE -52 KG          | 21      | -     |
| CADET KUMITE MALE -57 KG          | 22      | -     |
| CADET KUMITE MALE -63 KG          | 28      | -     |
| CADET KUMITE MALE -70 KG          | 23      | -     |
| CADET KUMITE MALE 70+ KG          | 22      | -     |
| CADET KUMITE TEAM FEMALE          | -       | 9     |
| CADET KUMITE TEAM MALE            | -       | 9     |
| Cadet Kata Female                 | 22      | -     |
| Cadet Kata Male                   | 19      | -     |
| JUNIOR KUMITE FEMALE -48 KG       | 12      | -     |
| JUNIOR KUMITE FEMALE -53 KG       | 23      | -     |
| JUNIOR KUMITE FEMALE -59 KG       | 27      | -     |
| JUNIOR KUMITE FEMALE 59+ KG       | 25      | -     |
| JUNIOR KUMITE MALE -55 KG         | 16      | -     |
| JUNIOR KUMITE MALE -61 KG         | 25      | -     |
| JUNIOR KUMITE MALE -68 KG         | 33      | -     |
| JUNIOR KUMITE MALE -76 KG         | 23      | -     |
| JUNIOR KUMITE MALE 76+ KG         | 22      | -     |
| JUNIOR KUMITE TEAM FEMALE         | -       | 8     |
| JUNIOR KUMITE TEAM MALE           | -       | 8     |
| Junior Kata Female                | 26      | -     |
| Junior Kata Male                  | 23      | -     |
| KATA TEAM CADET AND JUNIOR FEMALE | -       | 5     |
| KATA TEAM CADET AND JUNIOR MALE   | -       | 6     |
| Kata Team female U21              | -       | 2     |
| Kata Team male U21                | -       | 1     |
| Kumite Team female U21            | -       | 7     |

## 21st Balkan Karate Championships for Cadets, J ..

CROATIA  
RIJEKA

2021.11.26 - 2021.11.28

### Statistics









|                          |            |           |
|--------------------------|------------|-----------|
| Kumite Team male U21     | -          | 7         |
| U21 KUMITE FEMALE -50 KG | 12         | -         |
| U21 KUMITE FEMALE -55 KG | 15         | -         |
| U21 KUMITE FEMALE -61 KG | 17         | -         |
| U21 KUMITE FEMALE -68 KG | 16         | -         |
| U21 KUMITE FEMALE 68+ KG | 13         | -         |
| U21 KUMITE MALE -60 KG   | 14         | -         |
| U21 KUMITE MALE -67 KG   | 18         | -         |
| U21 KUMITE MALE -75 KG   | 20         | -         |
| U21 KUMITE MALE -84 KG   | 16         | -         |
| U21 KUMITE MALE 84+ KG   | 20         | -         |
| U21 Kata Female          | 23         | -         |
| U21 Kata Male            | 21         | -         |
| <b>Totals:</b>           | <b>697</b> | <b>62</b> |

## 21st Balkan Karate Championships for Cadets, J ..

CROATIA  
RIJEKA

2021.11.26 - 2021.11.28

### Participation Count - Officials





























| #              | Code  | Country                | Coaches | Officials | Referees | Total |
|----------------|---|------------------------|---------|-----------|----------|-------|
| 1              |  ALB | ALBANIA                | 1       | 1         | 0        | 2     |
| 2              |  BIH | BOSNIA AND HERZEGOVINA | 27      | 1         | 6        | 34    |
| 3              |  BUL | BULGARIA               | 5       | 0         | 3        | 8     |
| 4              |  CRO | CROATIA                | 55      | 0         | 10       | 65    |
| 5              |  CYP | CYPRUS                 | 1       | 0         | 0        | 1     |
| 6              |  GRE | GREECE                 | 10      | 4         | 8        | 22    |
| 7              |  KOS | KOSOVO                 | 21      | 1         | 3        | 25    |
| 8              |  MNE | MONTENEGRO             | 10      | 5         | 4        | 19    |
| 9              |  MKD | NORTH MACEDONIA        | 11      | 2         | 3        | 16    |
| 10             |  ROU | ROMANIA                | 7       | 0         | 1        | 8     |
| 11             |  SRB | SERBIA                 | 9       | 6         | 10       | 25    |
| 12             |  SLO | SLOVENIA               | 8       | 1         | 3        | 12    |
| 13             |  TUR | TURKEY                 | 17      | 4         | 19       | 40    |
| <b>Totals:</b> |   |                        | 182     | 25        | 70       | 277   |

# 21st Balkan Karate Championships for Cadets, J ..

CROATIA  
RIJEKA

2021.11.26 - 2021.11.28

## Officials Registration

| Coach |          |   |     |         |            |
|-------|----------|---|-----|---------|------------|
| 1     | ALBV0036 |    | ALB | LIRIM   | DEDEJ      |
| 2     | BIH2219  |    | BIH | MUJO    | BEGIC_     |
| 3     | BIHV0119 |    | BIH | MIODRAG | BOROVCANIN |
| 4     | BIH2198  |    | BIH | BRANKO  | DERAJIC_   |
| 5     | BIHV0109 |    | BIH | NEBOJSA | DEVIC      |
| 6     | BIH2762  |    | BIH | BAJRO   | DURDZIC    |
| 7     |          |    | BIH | SABINA  | DURDZIC    |
| 8     | BIH314   |    | BIH | ERVIN   | GALIC      |
| 9     | BIH03871 |    | BIH | NISVET  | GASAL      |
| 10    | BIHV0102 |    | BIH | VELIJA  | HALILOVIC  |
| 11    | BIH2553  |    | BIH | EDHEM   | HALILOVIC  |
| 12    | BIH2832  |  | BIH | MEHMED  | HALILOVIC  |
| 13    |          |  | BIH | ASMIR   | JAHIC      |
| 14    | BIHV0116 |  | BIH | FRANC   | JAKIC      |
| 15    | BIH2763  |  | BIH | ANTO    | KRESIC     |
| 16    | BIH2025  |  | BIH | MIRALEM | MANDZUKA   |
| 17    | BIH108   |  | BIH | DENIS   | MUHOVIC    |
| 18    | BIHV0025 |  | BIH | RAMIZ   | POTUR      |
| 19    | BIH2617  |  | BIH | SEJLA   | SALKIC     |
| 20    | BIH2616  |  | BIH | ADIS    | SALKIC     |
| 21    | BIH160   |  | BIH | UNA     | SELMAN     |
| 22    | BIH2511  |  | BIH | ARNES   | SELMAN     |
| 23    | BIHV0082 |  | BIH | ZIJAD   | SIPOVIC    |
| 24    | BIH128   |  | BIH | ARMIN   | TOPALOVIC  |
| 25    | BIH2528  |  | BIH | DEJAN   | VITOR      |
| 26    | BIH2532  |  | BIH | DEJAN   | VUKADIN    |
| 27    | BIH565   |  | BIH | ZELJKO  | ZOMBRA     |
| 28    | BIH161   |  | BIH | ADMIR   | ZUKAN      |
| 29    | BUL213   |  | BUL | VESELIN | DIMITROV   |

## 21st Balkan Karate Championships for Cadets, J ..

CROATIA  
RIJEKA

2021.11.26 - 2021.11.28

### Officials Registration

|    |          |   |     |           |             |
|----|----------|---|-----|-----------|-------------|
| 30 | BUL123   |    | BUL | ANGEL     | STEFANOV    |
| 31 | BULV0416 |    | BUL | TEODOR    | TODOROV     |
| 32 | BUL2078  |    | BUL | NIKOLAY   | TSANEV      |
| 33 | BUL2079  |    | BUL | LUCHEZAR  | TSVETKOV    |
| 34 |          |    | CRO | DAMIR     | BARIC       |
| 35 | CRO2037  |    | CRO | IVICA     | BARISEC     |
| 36 | CRO2970  |    | CRO | SENAD     | BARJAMOVIC  |
| 37 | CRO197   |    | CRO | IVANA     | BEBEK_BASIC |
| 38 | CRO2054  |    | CRO | BORAN     | BERAK       |
| 39 | CRO238   |    | CRO | STJEPAN   | BESENIC     |
| 40 | CRO2245  |    | CRO | TEA       | BESLIJA     |
| 41 | CRO2762  |    | CRO | ZVONKO    | BIONDIC     |
| 42 | CRO250   |  | CRO | MARIO     | BUDIMIR     |
| 43 | CRO2195  |  | CRO | DARKO     | BUNJEVAC    |
| 44 | CROV0242 |  | CRO | HRVOJE    | CEBIC       |
| 45 | CRO214   |  | CRO | ANAMARIJA | CELAN_BUJAS |
| 46 | CRO03010 |  | CRO | VIKTOR    | CUBRIC      |
| 47 | CRO2594  |  | CRO | ANTE      | CUTURA      |
| 48 | CRO109   |  | CRO | VANESA    | CVJETAN     |
| 49 | CRO176   |  | CRO | DANIL     | DOMDJONI    |
| 50 | CROV0035 |  | CRO | JOCO      | DUKIC       |
| 51 | CRO2168  |  | CRO | IVA       | DUZIC       |
| 52 | CRO2643  |  | CRO | DENIS     | FILES       |
| 53 | CROV0040 |  | CRO | DRAGUTIN  | GALINA      |
| 54 | CRO2191  |  | CRO | TIHOMIR   | GRGIC       |
| 55 | CRO2139  |  | CRO | NENAD     | HORVAT      |
| 56 | CROV0021 |  | CRO | ZDENKO    | HORVAT      |
| 57 | CRO03283 |  | CRO | GORAN     | JAJTIC      |
| 58 | CRO246   |  | CRO | MAJA      | LENARD      |



## 21st Balkan Karate Championships for Cadets, J ..

CROATIA  
RIJEKA

2021.11.26 - 2021.11.28

### Officials Registration





|    |              |   |     |           |            |
|----|--------------|---|-----|-----------|------------|
| 59 | CRO21<br>93  |    | CRO | KRISTIJAN | LESJAK     |
| 60 | CRO27<br>61  |    | CRO | IGOR      | LOVREKOVIC |
| 61 | CRO03<br>405 |    | CRO | TOMISLAV  | MAGDALENIC |
| 62 | CRO20<br>44  |    | CRO | DARIO     | MARAVIC    |
| 63 | CRO03<br>239 |    | CRO | GORAN     | MATOSEVIC  |
| 64 |              |    | CRO | DAVOR     | MRZAK      |
| 65 | CRO03<br>157 |    | CRO | DZEZIMIR  | MURATAGIC  |
| 66 | CRO20<br>12  |    | CRO | ZDRAVKO   | NALETINA   |
| 67 | CROV0<br>137 |    | CRO | FEDOR     | NALIS      |
| 68 | CRO20<br>27  |    | CRO | FILIP     | NOVAK      |
| 69 | CRO37<br>8   |    | CRO | MARKO     | OPANCAR    |
| 70 | CRO24<br>39  |    | CRO | MARKO     | PALIAGA    |
| 71 | CRO19<br>6   |  | CRO | RENE      | PERNUS     |
| 72 |              |  | CRO | RENE      | PERNUS     |
| 73 | CRO21<br>81  |  | CRO | JOSIP     | PETKOVIC   |
| 74 | CRO28<br>77  |  | CRO | ZARKO     | PLANINIC   |
| 75 | CRO27<br>66  |  | CRO | SAMUEL    | ROKSANDIC  |
| 76 | CROV0<br>232 |  | CRO | GORAN     | ROMIC      |
| 77 | CROV0<br>017 |  | CRO | DARKO     | SIMUNEC    |
| 78 | CRO22<br>31  |  | CRO | DEJAN     | SLUKIC     |
| 79 | CRO03<br>551 |  | CRO | DARKO     | STANCIC    |
| 80 | CRO28<br>79  |  | CRO | GORAN     | STIMAC     |
| 81 | CRO28<br>80  |  | CRO | MLADEN    | VIZINGER   |
| 82 | CRO15<br>1   |  | CRO | DANIJEL   | VUCIC      |
| 83 | CRO11<br>9   |  | CRO | MARIO     | VUCIC      |
| 84 | CRO28<br>81  |  | CRO | DALIBOR   | VUCIC      |
| 85 | CRO20<br>00  |  | CRO | BORIS     | VUJICIC    |
| 86 | CRO11<br>8   |  | CRO | ALEN      | ZAMLIC     |
| 87 | CRO23<br>21  |  | CRO | DENIS     | ZDERIC     |

## 21st Balkan Karate Championships for Cadets, J ..

CROATIA  
RIJEKA

2021.11.26 - 2021.11.28

### Officials Registration

|     |          |   |     |              |                |
|-----|----------|---|-----|--------------|----------------|
| 88  | CRO188   |    | CRO | GORAN        | ZIVKOVIC       |
| 89  | CYP2165  |    | CYP | GEORGE       | EFTHYMIU       |
| 90  | GRE02833 |    | GRE | THOMAS       | DERVISIS       |
| 91  | GRE02843 |    | GRE | DIMITRIOS    | GKOREZIS       |
| 92  | GRE2024  |    | GRE | KONSTANTINOS | GKOUVOUSIS     |
| 93  | GRE124   |    | GRE | THEODOROS    | KOUROUPIS      |
| 94  | GRE127   |    | GRE | SPYRIDON     | MARGARITPOULOS |
| 95  | GRE02739 |    | GRE | SPYRIDOULA   | PITHAMITSI     |
| 96  | GRE114   |    | GRE | DIMITRIOS    | TRIANTAFYLLIS  |
| 97  | GREV0434 |    | GRE | IOANNIS      | TSAROUCHAS     |
| 98  | GREV0445 |    | GRE | GEORGIOS     | TZANOS         |
| 99  | GRE02832 |    | GRE | DIONYSIOS    | XENOS          |
| 100 | KOS2083  |  | KOS | BAJRAM       | BAJRAMI        |
| 101 | KOS2047  |  | KOS | SHKELZEN     | BALAJ          |
| 102 | KOS2389  |  | KOS | IDRIZ        | BARUTI         |
| 103 | KOS02560 |  | KOS | ALBAN        | BEQIRI         |
| 104 | KOS02561 |  | KOS | FIDAIR       | BERISHA        |
| 105 | KOS02562 |  | KOS | LULZIM       | BERISHA        |
| 106 | KOS02563 |  | KOS | SHKELZEN     | BERISHA_       |
| 107 | KOS2048  |  | KOS | ISAK         | CURRI          |
| 108 | KOS2090  |  | KOS | NAZMI        | GASHI          |
| 109 | KOS02864 |  | KOS | VISAR_       | HOXHA_         |
| 110 | KOS02861 |  | KOS | GRANIT_      | HYKOLLI_       |
| 111 | KOS02862 |  | KOS | NEXHMEDIN_   | ISUFI_         |
| 112 | KOS02569 |  | KOS | HALIL        | MAHALLA        |
| 113 | KOS02554 |  | KOS | LEUTRIM      | PEPAJ          |
| 114 | KOS02863 |  | KOS | NUHI_        | REXHEPI_       |
| 115 | KOS2091  |  | KOS | SHKELZEN     | SHALA          |
| 116 | KOS02572 |  | KOS | LULJETA      | SHALA          |

## 21st Balkan Karate Championships for Cadets, J ..

CROATIA  
RIJEKA

2021.11.26 - 2021.11.28

### Officials Registration





























|     |              |   |     |                 |                 |
|-----|--------------|---|-----|-----------------|-----------------|
| 117 | KOS02<br>573 |    | KOS | QENDRIM         | SHAQIRI         |
| 118 | KOS02<br>555 |    | KOS | NAIM            | SHATRI          |
| 119 | KOS20<br>73  |    | KOS | YLBER           | SYLA            |
| 120 | KOS21<br>69  |    | KOS | AGRON           | TOSUNI          |
| 121 | MNE24<br>77  |    | MNE | ALEKSANDAR      | AJKOVIC         |
| 122 | MNE02<br>890 |    | MNE | ALEKSANDAR      | CALIC           |
| 123 | MNE10<br>5   |    | MNE | ALMIR           | CECUNJANIN      |
| 124 |              |    | MNE | MARIO           | HODZIC          |
| 125 | MNE24<br>78  |    | MNE | GORAN           | MADIC           |
| 126 | MNE14<br>7   |    | MNE | GORAN           | MARJANOVIC      |
| 127 | MNEV0<br>069 |    | MNE | LEK             | MARKIC          |
| 128 | MNE24<br>23  |    | MNE | SLADJAN         | MIKULIC         |
| 129 | MNEV0<br>071 |  | MNE | ZARKO           | RAKOVIC         |
| 130 | MNE24<br>81  |  | MNE | NENAD           | VOJINOVIC       |
| 131 | MKDV0<br>095 |  | MKD | STOJAN          | ANDRIEVSKI      |
| 132 | MKDV0<br>081 |  | MKD | PETAR           | BELISTOJANOVSKI |
| 133 | MKDV0<br>063 |  | MKD | ALIM            | HAJREDINI       |
| 134 | MKDV0<br>084 |  | MKD | ARLIND          | HUSEINI         |
| 135 | MKD26<br>6   |  | MKD | PULEKSENIJA     | JOVANOSKA       |
| 136 | MKD10<br>3   |  | MKD | ALEKSANDAR      | KUZMANOVSKI     |
| 137 | MKD11<br>6   |  | MKD | KRISTIJAN       | MLADENOVSKI     |
| 138 | MKD21<br>8   |  | MKD | MARTIN          | NESTOROVSKI     |
| 139 | MKD25<br>92  |  | MKD | DURIM           | PACHOKU         |
| 140 | MKD20<br>53  |  | MKD | BOSHKO          | ZABORSKI        |
| 141 | MKD53<br>4   |  | MKD | PETAR           | ZABORSKI        |
| 142 | ROU13<br>3   |  | ROU | CATALIN         | DUMITRU         |
| 143 | ROUV0<br>078 |  | ROU | GERI_CONSTANTIN | MITROI          |
| 144 | ROU20<br>32  |  | ROU | ION             | MUNTEANU        |
| 145 | ROU03<br>102 |  | ROU | VIOREL          | PEAGU           |

## 21st Balkan Karate Championships for Cadets, J ..

CROATIA  
RIJEKA

2021.11.26 - 2021.11.28

### Officials Registration









|     |              |   |     |                     |             |
|-----|--------------|---|-----|---------------------|-------------|
| 146 | ROU02<br>979 |    | ROU | CATALIN_MARIAN      | POPESCU     |
| 147 | ROU25<br>05  |    | ROU | COSTIN              | STANCIU     |
| 148 | ROU02<br>722 |    | ROU | DRAGOS              | VARZARU     |
| 149 | SRBV0<br>072 |    | SRB | MILOS               | ERIC        |
| 150 | SRB17<br>1   |    | SRB | NEMANJA             | GLISIC      |
| 151 | SRBV0<br>026 |    | SRB | NINOSLAV            | GLISIC      |
| 152 | SRB24<br>61  |    | SRB | MILENKO             | ORDAGIC     |
| 153 | SRB20<br>25  |    | SRB | MIRKO               | PUZOVIC     |
| 154 | SRB03<br>277 |    | SRB | ZARKO               | RADOVANOVIC |
| 155 | SRBV0<br>006 |    | SRB | GORAN               | SCEPANOVIC  |
| 156 | SRB03<br>364 |    | SRB | NOVICA              | SRECKOVIC   |
| 157 | SRBV0<br>005 |    | SRB | PREDRAG             | STOJADINOV  |
| 158 | SLO27<br>0   |  | SLO | NEJC                | BERTONCELJ  |
| 159 | SLO22<br>2   |  | SLO | TJASA               | BERTONCELJ  |
| 160 | SLO23<br>7   |  | SLO | LUKA                | DEBERSEK    |
| 161 |              |  | SLO | Štefka              | Golac       |
| 162 | SLO20<br>30  |  | SLO | NATALIJA            | KENDA       |
| 163 | SLO16<br>5   |  | SLO | MATIJA              | MATIJEVIC   |
| 164 | SLO22<br>03  |  | SLO | STANE               | NADIZAR     |
| 165 | SLO22<br>60  |  | SLO | PETER               | SIRCELJ     |
| 166 | TUR03<br>856 |  | TUR | MUHAMMET_ABDULLATIF | ALTUNTAS    |
| 167 | TUR54<br>5   |  | TUR | HASAN               | CAKIRLAR    |
| 168 |              |  | TUR | CINAR               | CENGIZ      |
| 169 | TURV0<br>482 |  | TUR | MUHARREM_ALI        | CORA        |
| 170 | TUR24<br>78  |  | TUR | AHMET               | DALAN       |
| 171 | TURV0<br>120 |  | TUR | IBRAHIM             | ERCIN       |
| 172 | TUR23<br>21  |  | TUR | SALIHA_DOGANAY      | EREL        |
| 173 | TUR03<br>855 |  | TUR | MAHMUT              | GUMUSSAY    |
| 174 | TUR21<br>7   |  | TUR | ILKAY               | ILDAS       |

## 21st Balkan Karate Championships for Cadets, J ..

CROATIA  
RIJEKA

2021.11.26 - 2021.11.28

### Officials Registration

|     |              |   |     |              |        |
|-----|--------------|---|-----|--------------|--------|
| 175 | TUR30<br>38  |  | TUR | REYHAN_KOSAR | KIVRAK |
| 176 | TUR20<br>4   |  | TUR | MURAT_SALIH  | KURNAZ |
| 177 | TUR23<br>19  |  | TUR | EROL         | KUTLU  |
| 178 | TUR41<br>5   |  | TUR | IRFAN_TAMER  | MULHIM |
| 179 |              |  | TUR | KAYACIK      | NURKAN |
| 180 | TURV0<br>430 |  | TUR | UNAL         | POLAT  |
| 181 | TUR03<br>858 |  | TUR | SULTAN       | UNAL   |
| 182 | TUR03<br>857 |  | TUR | AYSE_MERYEM  | YAZAR  |

Entries: **182**

# 21st Balkan Karate Championships for Cadets, J ..

CROATIA  
RIJEKA

2021.11.26 - 2021.11.28

## Officials Registration

| Officials |              |   |     |                     |            |
|-----------|--------------|---|-----|---------------------|------------|
| 183       | ALB02<br>387 |    | ALB | KASTRIOT_           | PJETRI     |
| 184       | GREV0<br>429 |    | GRE | PERIKLIS            | KANELLIS   |
| 185       | GRE02<br>644 |    | GRE | ELISAVET_ELEFThERIA | NAXON      |
| 186       | GRE02<br>643 |    | GRE | GRIGORIOS           | SIETIS     |
| 187       | GRE02<br>530 |    | GRE | THEODOROS           | SIETIS     |
| 188       | KOS20<br>90  |    | KOS | NAZMI               | GASHI      |
| 189       | MNE10<br>8   |    | MNE | VELJKO              | BRNOVIC    |
| 190       | MNEV0<br>004 |    | MNE | DRAGOLJUB           | FATIC      |
| 191       | MNE25<br>53  |    | MNE | IVAN                | KRSTAJIC   |
| 192       | MNE22<br>51  |    | MNE | EMIL                | LICINA_    |
| 193       | MNEV0<br>035 |    | MNE | PERICA              | MARAS      |
| 194       | MKDV0<br>075 |  | MKD | BESNIK              | MURATI     |
| 195       | MKD20<br>18  |  | MKD | BRANKO              | TASEVSKI   |
| 196       | SRBV0<br>042 |  | SRB | KAJICA              | KALICANIN  |
| 197       | SRBV0<br>067 |  | SRB | MILAN               | LAKOVIC    |
| 198       | SRBV0<br>092 |  | SRB | ALEKSANDAR          | MIHAILOVIC |
| 199       | SRBV0<br>003 |  | SRB | SLAVOLJUB           | PIPER      |
| 200       | SRB20<br>42  |  | SRB | MILOJE              | STEFANOVIC |
| 201       | SRB20<br>07  |  | SRB | STRAHINJA           | TEPAVCEVIC |
| 202       | SLO23<br>12  |  | SLO | BORUT               | STROJIN    |
| 203       | TUR28<br>21  |  | TUR | ALI                 | BILDIRCIN  |
| 204       | TUR42<br>4   |  | TUR | MEHMET              | KOR        |



Entries: **22**

## 21st Balkan Karate Championships for Cadets, J ..

CROATIA  
RIJEKA

2021.11.26 - 2021.11.28

### Officials Registration

| VIP |  |   |     |           |       |
|-----|--|---|-----|-----------|-------|
| 205 |  |  | BIH | ALMIR     | ISMIC |
| 206 |  |  | TUR | BAYRAKTAR | ORHAN |
| 207 |  |  | TUR | BAYRAKTAR | RABIN |

Entries: 3













# 21st Balkan Karate Championships for Cadets, J ..

CROATIA  
RIJEKA

2021.11.26 - 2021.11.28

## Officials Registration

| Referee |          |   |     |            |              |
|---------|----------|---|-----|------------|--------------|
| 208     | BIHV0002 |    | BIH | NERMIN     | BABIC        |
| 209     | BIHV0143 |    | BIH | DENIS      | BRCANINOVIC  |
| 210     | BIH2544  |    | BIH | BIRSEN     | ELJAZOVIC    |
| 211     | BIH2802  |    | BIH | ALMIR      | GLAVIC       |
| 212     | BIH2512  |    | BIH | GORAN      | IVKOVIC      |
| 213     |          |    | BIH | DALIBOR    | SIMIC        |
| 214     | BUL2253  |    | BUL | KRASSEN    | HADJIEV      |
| 215     | BUL2338  |    | BUL | VLADISLAV  | SHISHKOV     |
| 216     | BULV0402 |    | BUL | NADEZHDA   | SLAVKOVA     |
| 217     | CRO349   |    | CRO | DEJAN      | ALEKSIC      |
| 218     | CRO2097  |    | CRO | MONIKA     | BERULEC      |
| 219     | CRO2362  |  | CRO | GORAN      | BULJAN       |
| 220     |          |  | CRO | VLADIMIR   | CVJETAN      |
| 221     |          |  | CRO | NICOLE     | DELAC        |
| 222     | CRO03544 |  | CRO | IVANA      | KARAMATIC    |
| 223     |          |  | CRO | JADRANKA   | KOVACEVIC    |
| 224     |          |  | CRO | IVANA      | SOIC         |
| 225     | CRO03545 |  | CRO | MATEA      | TROSELJ      |
| 226     |          |  | CRO | MILAN      | UZELAC       |
| 227     | GREV0387 |  | GRE | DIMITRIOS  | ANASTASIADIS |
| 228     | GRE02721 |  | GRE | DIMITRIOS  | ARSENIADIS   |
| 229     | GRE02844 |  | GRE | EVANGELOS  | DIMOU        |
| 230     | SPID2096 |  | GRE | PANAGIOTIS | GOREZIS      |
| 231     | GRE02839 |  | GRE | VASILIKI   | KALOGERA     |
| 232     | SPID2119 |  | GRE | IOANNIS    | KANELIS      |
| 233     | GREV0002 |  | GRE | GIORGOS    | LAZARIDIS    |
| 234     | SPID2166 |  | GRE | NIKOLAOS   | PANETSIDIS   |
| 235     | KOS2032  |  | KOS | GAZMEND    | HAVOLLI      |
| 236     | ALB2003  |  | KOS | ARDIAN     | MUHADRI      |

## 21st Balkan Karate Championships for Cadets, J ..

CROATIA  
RIJEKA

2021.11.26 - 2021.11.28

### Officials Registration

|     |              |   |     |                 |                |
|-----|--------------|---|-----|-----------------|----------------|
| 237 | KOS24<br>70  |    | KOS | ALI             | VOKSHI         |
| 238 | MNEV0<br>032 |    | MNE | DRAGAN          | CIROVIC        |
| 239 | MNE23<br>00  |    | MNE | NAIM            | DURAKU         |
| 240 | MNEV0<br>013 |    | MNE | MIODRAG         | RADUNOVIC      |
| 241 | MNE10<br>6   |    | MNE | TOKO            | RAICEVIC       |
| 242 | MKDV0<br>070 |    | MKD | BLAGOJ          | ATANASOV       |
| 243 | MKDV0<br>102 |    | MKD | LAZAR           | JORDANOV       |
| 244 | MKD36<br>2   |    | MKD | EMIR            | KJOSOVIKJ      |
| 245 | ROU25<br>01  |    | ROU | VASILE_OCTAVIAN | POMARLEANU     |
| 246 | SRBV0<br>001 |    | SRB | STEVAN          | BRAJOVIC       |
| 247 | SRB03<br>280 |    | SRB | ANDJELA         | CUBRANOVIC     |
| 248 | SRBV0<br>105 |   | SRB | MIROSLAV        | DRAGOJLOVIC    |
| 249 | SRBV0<br>022 |  | SRB | MIROSLAV        | ILIC           |
| 250 | SRBV0<br>021 |  | SRB | MILETA          | KOPRIVICA      |
| 251 | SRBV0<br>014 |  | SRB | MILAN           | KOVACEVIC      |
| 252 | SRB03<br>110 |  | SRB | DJORDJE         | PETROVIC       |
| 253 | SRB27<br>90  |  | SRB | ANDJELKA        | SAVIJA         |
| 254 | SRB03<br>279 |  | SRB | ALEKSANDAR      | STANISAVLJEVIC |
| 255 | SRB12<br>7   |  | SRB | MILENA          | STANOJEVIC     |
| 256 | SLOV0<br>018 |  | SLO | MARJAN          | GREIFONER      |
| 257 | SLOV0<br>028 |  | SLO | MILENKO         | RAILIC         |
| 258 | SLO22<br>63  |  | SLO | DRAZEN          | STJEPANOVIC    |
| 259 | TURV0<br>373 |  | TUR | ILKER_BORA      | AKIL           |
| 260 | TUR25<br>15  |  | TUR | FATMA           | AKTEPE         |
| 261 | TUR30<br>95  |  | TUR | DILEK           | BILMEZ         |
| 262 | TUR31<br>00  |  | TUR | MEHMET_ERDINC   | CELIK          |
| 263 | TUR29<br>29  |  | TUR | SEVGI           | ERTUG          |
| 264 | TUR03<br>860 |  | TUR | MEHMET          | ERZIN          |
| 265 | TUR31<br>03  |  | TUR | NIHAL           | FIDAN          |

## 21st Balkan Karate Championships for Cadets, J ..

CROATIA  
RIJEKA

2021.11.26 - 2021.11.28

### Officials Registration

|     |              |   |     |         |         |
|-----|--------------|---|-----|---------|---------|
| 266 | TUR30<br>93  |  | TUR | BURAK   | GULMEZ  |
| 267 | TURV0<br>546 |  | TUR | ISMAIL  | GUNAY   |
| 268 | TUR30<br>98  |  | TUR | ESEF    | KARATAS |
| 269 | TURV0<br>350 |  | TUR | HAZIM   | OZDEMIR |
| 270 | TUR26<br>73  |  | TUR | OMER    | PATIR   |
| 271 | TUR26<br>36  |  | TUR | ALI     | SAHIN   |
| 272 | TURV0<br>550 |  | TUR | MEMDUH  | SAKARYA |
| 273 | TURV0<br>060 |  | TUR | AHMET   | SAN     |
| 274 | TUR31<br>02  |  | TUR | MUSTAFA | SIRAY   |
| 275 | TURV0<br>076 |  | TUR | SALIH   | SUER    |
| 276 | TUR29<br>17  |  | TUR | SAIT    | UZUN    |
| 277 | TUR29<br>32  |  | TUR | RESIT   | YAVUZ   |

Entries: **70**

# 21st Balkan Karate Championships for Cadets, J ..

---

CROATIA  
RIJEKA

2021.11.26 - 2021.11.28

## Officials Registration

Total Entries:**277**

**21st Balkan Karate Championships for Cadets,  
Juniors and U21 - RIJEKA 2021 - 2021-11-26**

**Cadet Kata Female**

**R1 G1/2 (11) Tatami 4 09:00**

| Competitors                 | Kata              | 1T    | 1A    | 2T    | 2A    | 3T    | 3A    | 4T    | 4A    | 5T    | 5A    | 6T | 6A | 7T | 7A | TEC   | ATH  | Extra | Total | Rank |
|-----------------------------|-------------------|-------|-------|-------|-------|-------|-------|-------|-------|-------|-------|----|----|----|----|-------|------|-------|-------|------|
| 1 KOSTOVA VELIZARA (BUL)    | 047 KURURUNFA     | 6.8   | 6.4   | (7.0) | 6.8   | (5.6) | (5.2) | 6.6   | 6.6   | 6.8   | (7.0) |    |    |    |    | 14.14 | 5.94 |       | 20.08 | 10   |
| 2 MILOSEVIC NEDA (SRB)      | 021 GOJUSHIHO SHO | (7.8) | 7.6   | 7.8   | (7.8) | 7.4   | (7.2) | (7.2) | 7.4   | 7.6   | 7.4   |    |    |    |    | 15.96 | 6.72 |       | 22.68 | 1    |
| 3 STANOJEVIC KRISTINA (BIH) | 020 GOJUSHIHO DAI | (7.6) | (8.0) | 7.6   | 7.6   | 7.2   | 7.2   | (6.4) | (6.8) | 7.2   | 7.0   |    |    |    |    | 15.4  | 6.54 |       | 21.94 | 5    |
| 4 COPII FRANCESCA (ROU)     | 041 KANKU SHO     | 7.0   | 7.0   | (7.2) | 7.0   | 6.2   | (6.0) | (6.0) | 6.6   | 6.8   | (7.2) |    |    |    |    | 14.0  | 6.18 |       | 20.18 | 9    |
| 5 BOCKOR EMMA_BERTA (CRO)   | 002 ANAN DAI      | (8.0) | (7.6) | 7.4   | 7.2   | 7.6   | 7.6   | (7.0) | (7.0) | 7.4   | 7.0   |    |    |    |    | 15.68 | 6.54 |       | 22.22 | 3    |
| 6 KOCAN ARIJANA (MNE)       | 021 GOJUSHIHO SHO | (7.2) | 7.2   | (7.6) | (7.4) | 7.4   | 7.0   | 7.2   | (6.8) | 7.4   | 7.2   |    |    |    |    | 15.4  | 6.42 |       | 21.82 | 6    |
| 7 DURDZIC IMANA (BIH)       | 021 GOJUSHIHO SHO | 6.8   | 7.0   | (7.4) | (7.6) | 7.2   | 7.0   | (6.4) | (6.2) | 7.4   | 7.4   |    |    |    |    | 14.98 | 6.42 |       | 21.4  | 7    |
| 8 STOJKOVA DANKA (MKD)      | 020 GOJUSHIHO DAI | 7.6   | (7.6) | 7.6   | 7.6   | (7.8) | 7.4   | (6.6) | (6.8) | 7.6   | 7.2   |    |    |    |    | 15.96 | 6.66 |       | 22.62 | 2    |
| 9 ZAGER HANA (SLO)          | 020 GOJUSHIHO DAI | (6.6) | 6.6   | (7.2) | 7.0   | 6.6   | (6.2) | 6.6   | 6.4   | 6.8   | (7.4) |    |    |    |    | 14.0  | 6.0  |       | 20.0  | 11   |
| 10 TSIKMAKI ATHINA (GRE)    | 064 OHAN DAI      | 7.4   | 7.4   | 7.4   | 7.4   | (7.0) | (7.0) | 7.2   | 7.2   | (7.6) | (7.6) |    |    |    |    | 15.4  | 6.6  |       | 22.0  | 4    |
| 11 GRBIC GORDANA (SRB)      | 021 GOJUSHIHO SHO | (8.2) | (8.2) | 7.0   | 6.8   | (6.8) | (6.6) | 7.6   | 7.4   | 6.8   | 6.8   |    |    |    |    | 14.98 | 6.3  |       | 21.28 | 8    |

**R1 G2/2 (11) Tatami 4 09:55**

| Competitors                  | Kata                    | 1T    | 1A    | 2T    | 2A    | 3T    | 3A    | 4T    | 4A    | 5T    | 5A    | 6T | 6A | 7T | 7A | TEC   | ATH  | Extra | Total | Rank |
|------------------------------|-------------------------|-------|-------|-------|-------|-------|-------|-------|-------|-------|-------|----|----|----|----|-------|------|-------|-------|------|
| 1 LUJIC ANA (CRO)            |                         |       |       |       |       |       |       |       |       |       |       |    |    |    |    |       |      |       |       |      |
| 2 MINGOVSKA ANASTASIJA (MKD) | 021 GOJUSHIHO SHO       | 7.8   | 7.8   | (8.2) | (8.0) | (7.6) | (7.6) | 8.0   | 7.8   | 7.8   | 7.8   |    |    |    |    | 16.52 | 7.02 |       | 23.54 | 2    |
| 3 EVSAN ESMA_SILA (TUR)      | 021 GOJUSHIHO SHO       | (7.2) | 7.6   | (7.8) | (7.4) | 7.8   | (7.8) | 7.6   | 7.4   | 7.4   | 7.4   |    |    |    |    | 15.96 | 6.72 |       | 22.68 | 4    |
| 4 PASALIC ESMA (BIH)         | 021 GOJUSHIHO SHO       | (6.8) | (7.4) | 7.2   | (7.0) | (7.4) | 7.2   | 7.4   | 7.2   | 7.2   | 7.4   |    |    |    |    | 15.26 | 6.54 |       | 21.8  | 8    |
| 5 JOVANOVIC SAVA (SRB)       | 021 GOJUSHIHO SHO       | 8.0   | (8.2) | (8.4) | 8.2   | 8.0   | 8.2   | 7.8   | (7.6) | (7.6) | 7.6   |    |    |    |    | 16.66 | 7.2  |       | 23.86 | 1    |
| 6 BACIU MARIA (ROU)          | 008 CHATANYARA KUSHANKU | (6.8) | 7.0   | 6.8   | (6.6) | (7.8) | (7.8) | 7.4   | 7.4   | 6.8   | 6.8   |    |    |    |    | 14.7  | 6.36 |       | 21.06 | 9    |
| 7 SEGAVCIC KATIA (CRO)       | 078 SANSAN              | (7.6) | 7.8   | 7.6   | (7.4) | (8.4) | (8.2) | 7.6   | 7.6   | 7.8   | 7.6   |    |    |    |    | 16.1  | 6.9  |       | 23.0  | 3    |
| 8 NASTAS PATRICIA (ROU)      | 047 KURURUNFA           | (7.2) | 7.2   | 7.2   | (6.6) | 7.4   | 7.2   | 7.4   | 7.6   | (7.6) | (7.8) |    |    |    |    | 15.4  | 6.6  |       | 22.0  | 7    |
| 9 REGKLI THEONI (GRE)        | 021 GOJUSHIHO SHO       | (6.6) | 7.2   | 6.6   | (6.4) | 7.2   | 6.8   | 7.2   | 6.8   | (7.4) | (7.6) |    |    |    |    | 14.7  | 6.24 |       | 20.94 | 10   |
| 10 PESTALIC MERJEMA (BIH)    | 078 SANSAN              | 7.6   | (7.4) | (7.8) | (7.2) | 7.6   | 7.2   | 7.4   | 7.4   | (7.2) | 7.4   |    |    |    |    | 15.82 | 6.6  |       | 22.42 | 5    |
| 11 LAZANSKI MAJA (SLO)       | 067 PAIKU               | (8.0) | 7.6   | 7.4   | (7.0) | 7.8   | (8.0) | (7.2) | 7.0   | 7.2   | 7.4   |    |    |    |    | 15.68 | 6.6  |       | 22.28 | 6    |

**R2-G1 Tatami 4 10:50**

| Competitors               | Kata                    | 1T    | 1A    | 2T    | 2A    | 3T    | 3A    | 4T    | 4A    | 5T  | 5A  | 6T | 6A | 7T | 7A | TEC   | ATH  | Extra | Total | Rank |
|---------------------------|-------------------------|-------|-------|-------|-------|-------|-------|-------|-------|-----|-----|----|----|----|----|-------|------|-------|-------|------|
| 1 BOCKOR EMMA_BERTA (CRO) | 008 CHATANYARA KUSHANKU | 7.6   | 7.8   | 7.8   | (7.4) | (8.2) | (8.0) | (7.4) | 7.4   | 7.8 | 7.6 |    |    |    |    | 16.24 | 6.84 |       | 23.08 | 4    |
| 2 STOJKOVA DANKA (MKD)    | 021 GOJUSHIHO SHO       | (7.2) | (7.2) | 8.0   | 7.8   | (8.4) | (8.4) | 7.6   | 7.6   | 8.2 | 8.0 |    |    |    |    | 16.66 | 7.02 |       | 23.68 | 2    |
| 3 TSIKMAKI ATHINA (GRE)   | 009 CHIBANA NO KUSHANKU | (8.0) | 7.6   | (7.6) | (7.4) | 8.0   | (8.2) | 7.6   | 7.8   | 8.0 | 7.8 |    |    |    |    | 16.52 | 6.96 |       | 23.48 | 3    |
| 4 MILOSEVIC NEDA (SRB)    | 020 GOJUSHIHO DAI       | 8.4   | 8.2   | 8.2   | 8.0   | (8.6) | (8.4) | (7.8) | (7.6) | 8.4 | 8.2 |    |    |    |    | 17.5  | 7.32 |       | 24.82 | 1    |

**R2-G2 Tatami 4 11:10**

| Competitors                  | Kata          | 1T    | 1A    | 2T    | 2A    | 3T    | 3A    | 4T  | 4A  | 5T  | 5A  | 6T | 6A | 7T | 7A | TEC   | ATH  | Extra | Total | Rank |
|------------------------------|---------------|-------|-------|-------|-------|-------|-------|-----|-----|-----|-----|----|----|----|----|-------|------|-------|-------|------|
| 1 JOVANOVIC SAVA (SRB)       | 041 KANKU SHO | (8.4) | (8.2) | (7.8) | (7.6) | 8.2   | 8.2   | 8.0 | 8.0 | 8.0 | 7.8 |    |    |    |    | 16.94 | 7.2  |       | 24.14 | 2    |
| 2 EVSAN ESMA_SILA (TUR)      | 078 SANSAN    | (7.2) | (7.6) | 8.2   | 8.0   | (8.4) | (8.2) | 7.8 | 8.2 | 8.4 | 8.2 |    |    |    |    | 17.08 | 7.32 |       | 24.4  | 1    |
| 3 MINGOVSKA ANASTASIJA (MKD) | 015 GANKAKU   | (7.6) | (7.4) | 8.2   | 7.8   | (8.4) | (8.4) | 7.8 | 7.6 | 7.6 | 7.6 |    |    |    |    | 16.52 | 6.9  |       | 23.42 | 4    |
| 4 SEGAVCIC KATIA (CRO)       | 002 ANAN DAI  | 8.0   | 8.0   | (7.6) | (7.2) | (8.6) | (8.4) | 7.8 | 7.8 | 7.8 | 7.6 |    |    |    |    | 16.52 | 7.02 |       | 23.54 | 3    |

**R3 Bronze Medal Match 1 Tatami 4 11:30**

| Competitors            | Kata        | 1T    | 1A    | 2T    | 2A    | 3T  | 3A    | 4T  | 4A  | 5T    | 5A    | 6T | 6A | 7T | 7A | TEC   | ATH  | Extra | Total | Rank |
|------------------------|-------------|-------|-------|-------|-------|-----|-------|-----|-----|-------|-------|----|----|----|----|-------|------|-------|-------|------|
| 1 SEGAVCIC KATIA (CRO) | 015 GANKAKU | 8.0   | 8.0   | (8.4) | (8.4) | 8.0 | (7.8) | 8.0 | 8.0 | (7.8) | 8.2   |    |    |    |    | 16.8  | 7.26 |       | 24.06 | 1    |
| 2 STOJKOVA DANKA (MKD) | 015 GANKAKU | (7.4) | (7.4) | (8.2) | 8.0   | 7.6 | 7.4   | 7.6 | 7.8 | 7.6   | (8.4) |    |    |    |    | 15.96 | 6.96 |       | 22.92 | 2    |

**R3 Bronze Medal Match 2 Tatami 4 11:40**







| Competitors             | Kata              | 1T  | 1A  | 2T    | 2A  | 3T    | 3A    | 4T    | 4A    | 5T  | 5A  | 6T | 6A | 7T | 7A | TEC   | ATH  | Extra | Total | Rank |
|-------------------------|-------------------|-----|-----|-------|-----|-------|-------|-------|-------|-----|-----|----|----|----|----|-------|------|-------|-------|------|
| 1 JOVANOVIC SAVA (SRB)  | 020 GOJUSHIHO DAI | 8.2 | 8.0 | 8.2   | 8.2 | (8.0) | (7.8) | (8.4) | (8.4) | 8.0 | 8.2 |    |    |    |    | 17.08 | 7.32 |       | 24.4  | 1    |
| 2 TSIKMAKI ATHINA (GRE) | 001 ANAN          | 8.0 | 7.8 | (7.8) | 7.8 | 7.8   | (7.6) | (8.6) | (8.4) | 8.2 | 8.4 |    |    |    |    | 16.8  | 7.2  |       | 24.0  | 2    |

**R3 Gold Medal Match Tatami 4 11:50**

| Competitors             | Kata        | 1T  | 1A  | 2T    | 2A    | 3T    | 3A    | 4T  | 4A  | 5T    | 5A    | 6T | 6A | 7T | 7A | TEC   | ATH | Extra | Total | Rank |
|-------------------------|-------------|-----|-----|-------|-------|-------|-------|-----|-----|-------|-------|----|----|----|----|-------|-----|-------|-------|------|
| 1 EVSAN ESMA_SILA (TUR) | 015 GANKAKU | 8.2 | 8.0 | (8.4) | (8.4) | (8.0) | (7.8) | 8.0 | 8.0 | 8.2   | 8.0   |    |    |    |    | 17.08 | 7.2 |       | 24.28 | 2    |
| 2 MILOSEVIC NEDA (SRB)  | 099 UNSU    | 8.4 | 8.2 | (8.6) | (8.4) | 8.2   | 8.0   | 8.0 | 7.8 | (7.8) | (7.6) |    |    |    |    | 17.22 | 7.2 |       | 24.42 | 1    |

**21st Balkan Karate Championships for Cadets,  
Juniors and U21 - RIJEKA 2021 - 2021-11-26  
Cadet Kata Female**

**Results**

|   |                      |                 |   |                 |
|---|----------------------|-----------------|---|-----------------|
| 1 | MILOSEVIC NEDA       | SERBIA          |  | SERBIA          |
| 2 | EVSAN ESMA SILA      | TURKEY          |  | TURKEY          |
| 3 | SEGAVCIC KATIA       | CROATIA         |  | CROATIA         |
| 3 | JOVANOVIC SAVA       | SERBIA          |  | SERBIA          |
| 5 | STOJKOVA DANKA       | NORTH MACEDONIA |  | NORTH MACEDONIA |
| 5 | TSIAKMAKI ATHINA     | GREECE          |  | GREECE          |
| 7 | BOCKOR EMMA BERTA    | CROATIA         |  | CROATIA         |
| 7 | MINGOVSKA ANASTASIJA | NORTH MACEDONIA |  | NORTH MACEDONIA |

**21st Balkan Karate Championships for Cadets,  
Juniors and U21 - RIJEKA 2021 - 2021-11-26**

**Cadet Kata Male**

**R1 G1/2 (10) Tatami 4 09:35**

| Competitors                      | Kata              | 1T    | 1A    | 2T    | 2A    | 3T    | 3A    | 4T    | 4A    | 5T    | 5A    | 6T | 6A | 7T | 7A | TEC   | ATH  | Extra | Total Rank |
|----------------------------------|-------------------|-------|-------|-------|-------|-------|-------|-------|-------|-------|-------|----|----|----|----|-------|------|-------|------------|
| 1 BUDAN_PIRVU PATRICK_ALEX (ROU) | 021 GOJUSHIHO SHO | 6.6   | 6.8   | 7.0   | 6.8   | (6.2) | (6.0) | (7.8) | (7.6) | 7.2   | 7.2   |    |    |    |    | 14.56 | 6.24 |       | 20.8 8     |
| 2 NIKOLIC DIMITRIJE (SRB)        | 021 GOJUSHIHO SHO | (8.6) | (8.2) | 7.6   | 7.4   | (6.8) | (6.6) | 8.4   | 8.2   | 8.0   | 8.0   |    |    |    |    | 16.8  | 7.08 |       | 23.88 4    |
| 3 FILES MARK (CRO)               | 041 KANKU SHO     | (8.0) | 8.0   | (7.4) | (7.2) | 8.0   | 8.0   | 8.0   | 7.8   | 8.0   | (8.2) |    |    |    |    | 16.8  | 7.14 |       | 23.94 3    |
| 4 KOUTALIARIS DIMOSTHENIS (GRE)  | 019 GOJUSHIHO SHO | 6.2   | 6.4   | 6.8   | 6.6   | (6.0) | (6.0) | 7.0   | 6.8   | (7.4) | (7.4) |    |    |    |    | 14.0  | 5.94 |       | 19.94 10   |
| 5 SALKIC TARIK (BIH)             | 021 GOJUSHIHO SHO | (7.0) | (7.4) | 8.0   | 7.8   | (8.2) | 8.0   | 8.2   | 8.0   | 8.2   | (8.2) |    |    |    |    | 17.08 | 7.14 |       | 24.22 2    |
| 6 BOSKOV ALEKSANDAR (SRB)        | 021 GOJUSHIHO SHO | (8.8) | (8.6) | 7.4   | (7.0) | (7.2) | 7.0   | 7.8   | 7.8   | 7.6   | 7.6   |    |    |    |    | 15.96 | 6.72 |       | 22.68 5    |
| 7 DIMCHEVSKI MARIO (MKD)         | 021 GOJUSHIHO SHO | 7.0   | (7.2) | (7.6) | 7.0   | (6.6) | (6.6) | 7.2   | 7.0   | 7.0   | 7.0   |    |    |    |    | 14.84 | 6.3  |       | 21.14 7    |
| 8 GASHI LEART (KOS)              | 021 GOJUSHIHO SHO | 6.6   | 6.6   | 6.6   | (6.4) | (6.4) | 6.4   | 6.8   | (6.8) | (7.2) | 6.8   |    |    |    |    | 14.0  | 5.94 |       | 19.94 9    |
| 9 JANJIC ALEKSA (MNE)            | 021 GOJUSHIHO SHO | (8.2) | (8.2) | (6.8) | (6.2) | 7.4   | 7.2   | 7.6   | 7.6   | 7.4   | 7.6   |    |    |    |    | 15.68 | 6.72 |       | 22.4 6     |
| 10 HUIC DINO (CRO)               | 020 GOJUSHIHO DAI | (7.4) | (7.2) | 8.2   | 8.0   | (8.4) | 8.2   | 8.2   | 8.2   | (8.6) |       |    |    |    |    | 17.22 | 7.32 |       | 24.54 1    |

**R1 G2/2 (9) Tatami 4 10:25**

| Competitors                  | Kata              | 1T    | 1A    | 2T    | 2A    | 3T    | 3A    | 4T    | 4A  | 5T    | 5A    | 6T | 6A | 7T | 7A | TEC   | ATH  | Extra | Total Rank |
|------------------------------|-------------------|-------|-------|-------|-------|-------|-------|-------|-----|-------|-------|----|----|----|----|-------|------|-------|------------|
| 1 KUCUKALTIN ALPARSLAN (TUR) | 041 KANKU SHO     | 7.2   | 7.4   | (6.8) | (6.6) | (8.4) | (8.6) | 8.0   | 7.8 | 7.8   | 7.8   |    |    |    |    | 16.1  | 6.9  |       | 23.0 4     |
| 2 GERSCHWITZ AJSEL (MNE)     | 041 KANKU SHO     | 7.8   | 8.2   | 7.2   | (7.0) | (8.6) | (8.6) | 7.8   | 7.8 | (7.0) | 7.0   |    |    |    |    | 15.96 | 6.9  |       | 22.86 5    |
| 3 SADIKOVIC NADAL (BIH)      | 021 GOJUSHIHO SHO | 6.8   | 7.2   | (6.4) | (6.2) | (7.8) | (7.6) | 7.4   | 7.4 | 7.2   | 7.0   |    |    |    |    | 14.98 | 6.48 |       | 21.46 8    |
| 4 KEKO LUKA (CRO)            | 099 UNSU          | 6.4   | 6.2   | (6.2) | (6.0) | (6.8) | 6.4   | 6.8   | 6.6 | 6.8   | (6.8) |    |    |    |    | 14.0  | 5.76 |       | 19.76 9    |
| 5 DUGONJIC UROS (SRB)        | 041 KANKU SHO     | (8.4) | (8.2) | 8.0   | 7.8   | 8.2   | 7.8   | 8.2   | 8.0 | (7.6) | (7.6) |    |    |    |    | 17.08 | 7.08 |       | 24.16 1    |
| 6 RADISAVLJEVIC JOVAN (SRB)  | 020 GOJUSHIHO DAI | (8.6) | (8.4) | (7.0) | (6.6) | 8.2   | 8.2   | 7.8   | 7.8 | 7.6   | 7.2   |    |    |    |    | 16.52 | 6.96 |       | 23.48 2    |
| 7 ROSIC RIJAD (BIH)          | 021 GOJUSHIHO SHO | (7.0) | (7.0) | 7.4   | 7.0   | (8.0) | (7.8) | 7.6   | 7.6 | 7.6   | 7.4   |    |    |    |    | 15.82 | 6.6  |       | 22.42 7    |
| 8 TOTH MATEJ (CRO)           | 099 UNSU          | (7.4) | (7.2) | (7.8) | 7.2   | 7.8   | 7.6   | 7.4   | 7.2 | 7.4   | (7.8) |    |    |    |    | 15.82 | 6.6  |       | 22.42 6    |
| 9 POPTODOROV MARKO (MKD)     | 020 GOJUSHIHO DAI | (8.2) | (8.4) | 8.0   | 7.8   | 8.0   | 7.6   | (7.6) | 7.8 | 7.6   | (7.0) |    |    |    |    | 16.52 | 6.96 |       | 23.48 3    |

**R2-G1 Tatami 4 11:10**

| Competitors               | Kata              | 1T    | 1A    | 2T    | 2A    | 3T    | 3A    | 4T  | 4A    | 5T    | 5A  | 6T | 6A | 7T | 7A | TEC   | ATH  | Extra | Total Rank |
|---------------------------|-------------------|-------|-------|-------|-------|-------|-------|-----|-------|-------|-----|----|----|----|----|-------|------|-------|------------|
| 1 SALKIC TARIK (BIH)      | 020 GOJUSHIHO DAI | 7.8   | (7.6) | (8.6) | (8.6) | 8.2   | 8.2   | 8.2 | 8.2   | (7.6) | 7.8 |    |    |    |    | 16.94 | 7.26 |       | 24.2 2     |
| 2 NIKOLIC DIMITRIJE (SRB) | 020 GOJUSHIHO DAI | 7.6   | (7.4) | (8.4) | 8.2   | 8.4   | (8.4) | 8.4 | 8.4   | (7.4) | 7.4 |    |    |    |    | 17.08 | 7.2  |       | 24.28 1    |
| 3 HUIC DINO (CRO)         | 099 UNSU          | (8.2) | 8.0   | 8.2   | (8.2) | (7.8) | 7.8   | 7.8 | (7.6) | 8.0   | 8.2 |    |    |    |    | 16.8  | 7.2  |       | 24.0 3     |
| 4 FILES MARK (CRO)        | 099 UNSU          | (7.4) | (7.2) | (8.0) | (8.2) | 8.0   | 8.0   | 7.6 | 7.4   | 7.6   | 7.6 |    |    |    |    | 16.24 | 6.9  |       | 23.14 4    |

**R2-G2 Tatami 4 11:30**

| Competitors                  | Kata           | 1T    | 1A    | 2T    | 2A    | 3T  | 3A  | 4T    | 4A  | 5T  | 5A  | 6T | 6A | 7T | 7A | TEC   | ATH  | Extra | Total Rank |
|------------------------------|----------------|-------|-------|-------|-------|-----|-----|-------|-----|-----|-----|----|----|----|----|-------|------|-------|------------|
| 1 KUCUKALTIN ALPARSLAN (TUR) | 099 UNSU       | (7.4) | (7.2) | (8.0) | (8.2) | 7.4 | 7.2 | 7.6   | 7.4 | 8.0 | 8.2 |    |    |    |    | 16.1  | 6.84 |       | 22.94 4    |
| 2 RADISAVLJEVIC JOVAN (SRB)  | 041 KANKU SHO  | (7.6) | (7.4) | (8.4) | (8.4) | 8.2 | 8.2 | 8.0   | 7.8 | 7.8 | 7.6 |    |    |    |    | 16.8  | 7.08 |       | 23.88 3    |
| 3 DUGONJIC UROS (SRB)        | 099 UNSU       | (8.2) | (8.0) | (8.6) | (8.6) | 8.4 | 8.0 | 8.4   | 8.2 | 8.4 | 8.2 |    |    |    |    | 17.64 | 7.32 |       | 24.96 1    |
| 4 POPTODOROV MARKO (MKD)     | 092 SUPARINPEI | 8.0   | (7.6) | (8.8) | (8.4) | 8.4 | 8.2 | (7.8) | 7.6 | 7.8 | 7.8 |    |    |    |    | 16.94 | 7.08 |       | 24.02 2    |

**R3 Bronze Medal Match 1 Tatami 4 11:50**

| Competitors                 | Kata        | 1T    | 1A    | 2T    | 2A    | 3T  | 3A  | 4T  | 4A  | 5T    | 5A    | 6T | 6A | 7T | 7A | TEC   | ATH  | Extra | Total Rank |
|-----------------------------|-------------|-------|-------|-------|-------|-----|-----|-----|-----|-------|-------|----|----|----|----|-------|------|-------|------------|
| 1 SALKIC TARIK (BIH)        | 099 UNSU    | 8.4   | 8.2   | (8.8) | (8.8) | 8.4 | 8.2 | 8.4 | 8.4 | (7.8) | (8.0) |    |    |    |    | 17.64 | 7.44 |       | 25.08 1    |
| 2 RADISAVLJEVIC JOVAN (SRB) | 015 GANKAKU | (8.0) | (7.8) | (9.0) | (8.6) | 8.2 | 8.0 | 8.0 | 8.0 | 8.2   | 8.0   |    |    |    |    | 17.08 | 7.2  |       | 24.28 2    |



**R3 Bronze Medal Match 2 Tatami 4 12:00**

| Competitors              | Kata          | 1T    | 1A    | 2T    | 2A    | 3T  | 3A  | 4T  | 4A  | 5T    | 5A    | 6T | 6A | 7T | 7A | TEC   | ATH  | Extra | Total Rank |
|--------------------------|---------------|-------|-------|-------|-------|-----|-----|-----|-----|-------|-------|----|----|----|----|-------|------|-------|------------|
| 1 HUIC DINO (CRO)        | 041 KANKU SHO | (7.6) | (7.6) | (9.0) | (9.0) | 8.6 | 8.4 | 8.2 | 8.2 | 8.0   | 8.2   |    |    |    |    | 17.36 | 7.44 |       | 24.8 1     |
| 2 POPTODOROV MARKO (MKD) | 015 GANKAKU   | (8.4) | (8.2) | 8.4   | 8.0   | 8.0 | 7.8 | 7.4 | 7.6 | (6.8) | (6.6) |    |    |    |    | 16.66 | 7.02 |       | 23.68 2    |

**R3 Gold Medal Match Tatami 4 12:10**

| Competitors               | Kata          | 1T    | 1A    | 2T    | 2A    | 3T  | 3A  | 4T  | 4A  | 5T    | 5A  | 6T | 6A | 7T | 7A | TEC   | ATH | Extra | Total Rank |
|---------------------------|---------------|-------|-------|-------|-------|-----|-----|-----|-----|-------|-----|----|----|----|----|-------|-----|-------|------------|
| 1 NIKOLIC DIMITRIJE (SRB) | 041 KANKU SHO | (8.0) | (7.8) | (8.6) | (8.4) | 8.0 | 8.0 | 8.2 | 8.2 | 8.0   | 7.8 |    |    |    |    | 16.94 | 7.2 |       | 24.14 2    |
| 2 DUGONJIC UROS (SRB)     | 015 GANKAKU   | 8.4   | (8.2) | (8.8) | (8.6) | 8.4 | 8.4 | 8.4 | 8.4 | (8.2) | 8.2 |    |    |    |    | 17.64 | 7.5 |       | 25.14 1    |





**Results**

|   |                   |                        |   |                        |
|---|-------------------|------------------------|---|------------------------|
| 1 | DUGONJIC UROS     | SERBIA                 |  | SERBIA                 |
| 2 | NIKOLIC DIMITRIJE | SERBIA                 |  | SERBIA                 |
| 3 | SALKIC TARIK      | BOSNIA AND HERZEGOVINA |  | BOSNIA AND HERZEGOVINA |



**21st Balkan Karate Championships for Cadets,  
Juniors and U21 - RIJEKA 2021 - 2021-11-26**

**Cadet Kata Male**

|   |                      |                 |   |                 |
|---|----------------------|-----------------|---|-----------------|
| 3 | HUIC DINO            | CROATIA         |  | CROATIA         |
| 5 | RADISAVLJEVIC JOVAN  | SERBIA          |  | SERBIA          |
| 5 | POPTODOROV MARKO     | NORTH MACEDONIA |  | NORTH MACEDONIA |
| 7 | FILES MARK           | CROATIA         |  | CROATIA         |
| 7 | KUCUKALTIN ALPARSLAN | TURKEY          |  | TURKEY          |

# CADET KUMITE FEMALE -47 KG

21st Balkan Karate Championships for Cadets, Juniors and U21 - RIJEKA 2021, RIJEKA, CRO

Tatami  
1 09:00

Pool  
1/1

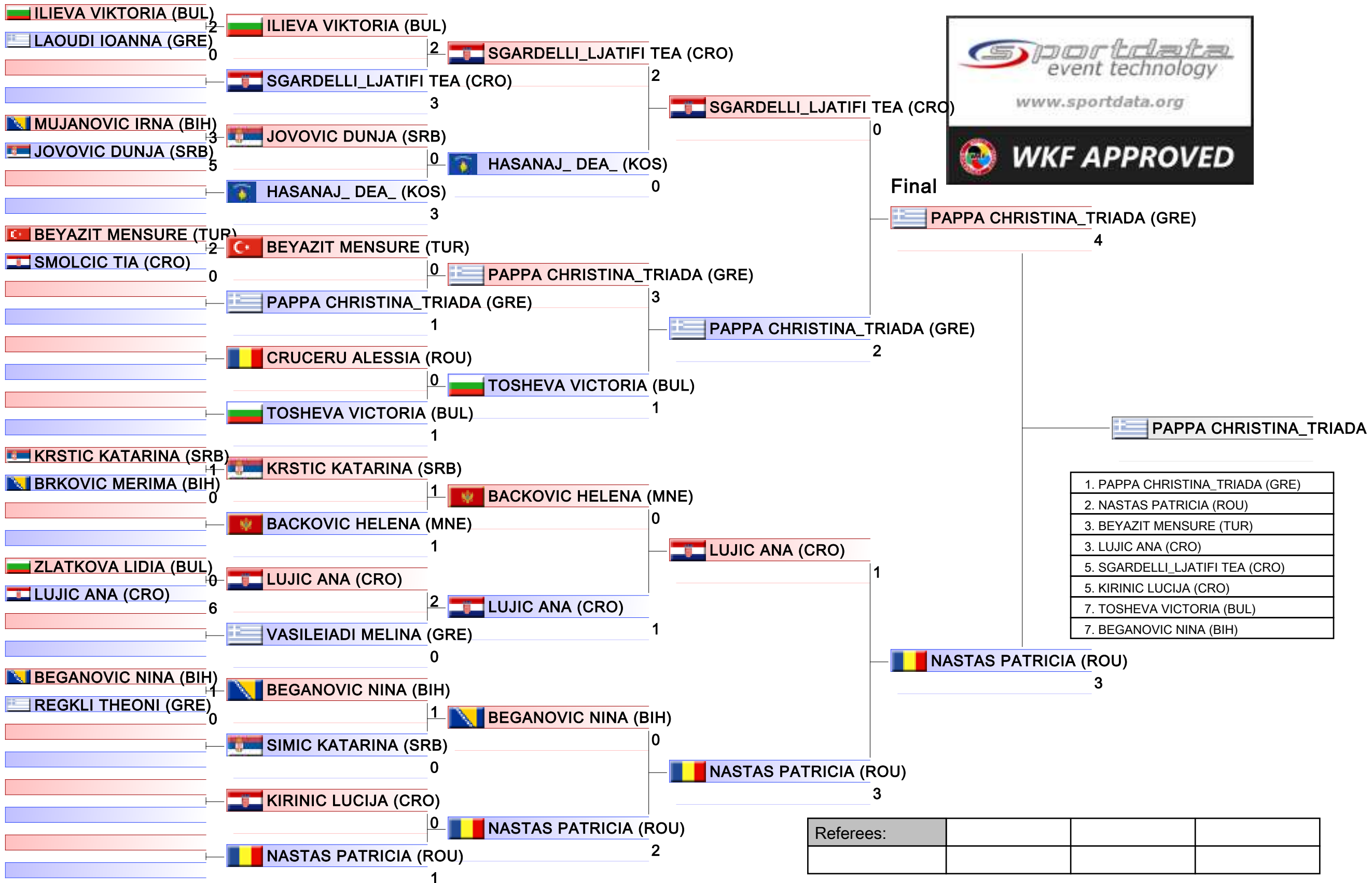

# CADET KUMITE FEMALE -47 KG

21st Balkan Karate Championships for Cadets, Juniors and U21 - RIJEKA 2021

(c)sportdata GmbH & Co KG 2000-2021(2021-11-29 16:49) -WKF Approved- v 9.8.8 build 3 (2021-11-04) License: SDIL Sportdata Internal License 2021 (expire 2021-12-31)

Tatami  
1 10:20

Pool  
1

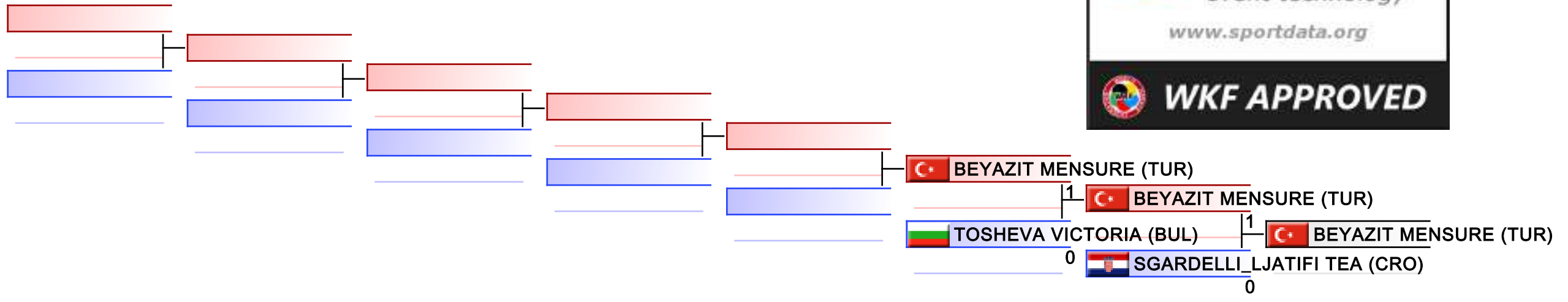

## REPECHAGE: (1)

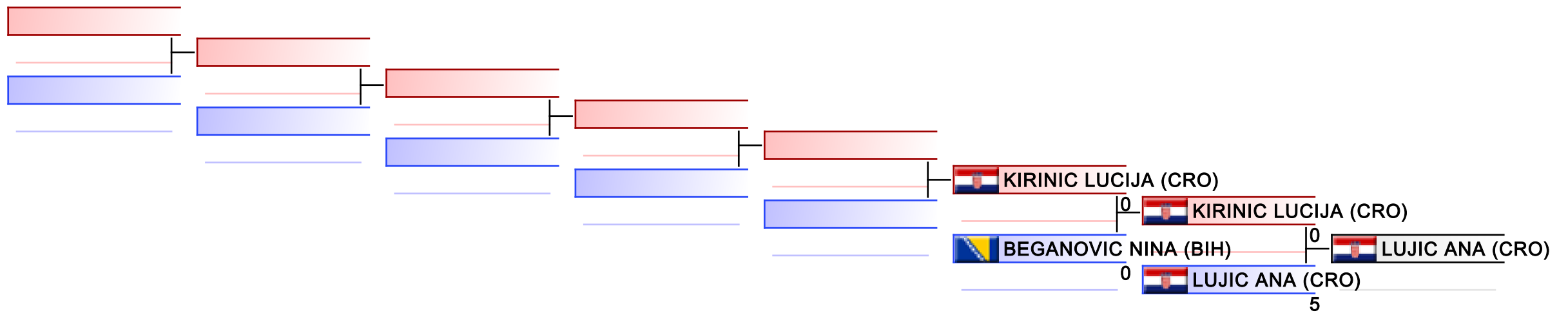

|           |  |  |  |  |  |  |  |
|-----------|--|--|--|--|--|--|--|
| Referees: |  |  |  |  |  |  |  |
|-----------|--|--|--|--|--|--|--|

# CADET KUMITE FEMALE -54 KG

21st Balkan Karate Championships for Cadets, Juniors and U21 - RIJEKA 2021, RIJEKA, CRO

Tatami  
1 10:55

Pool  
1/1

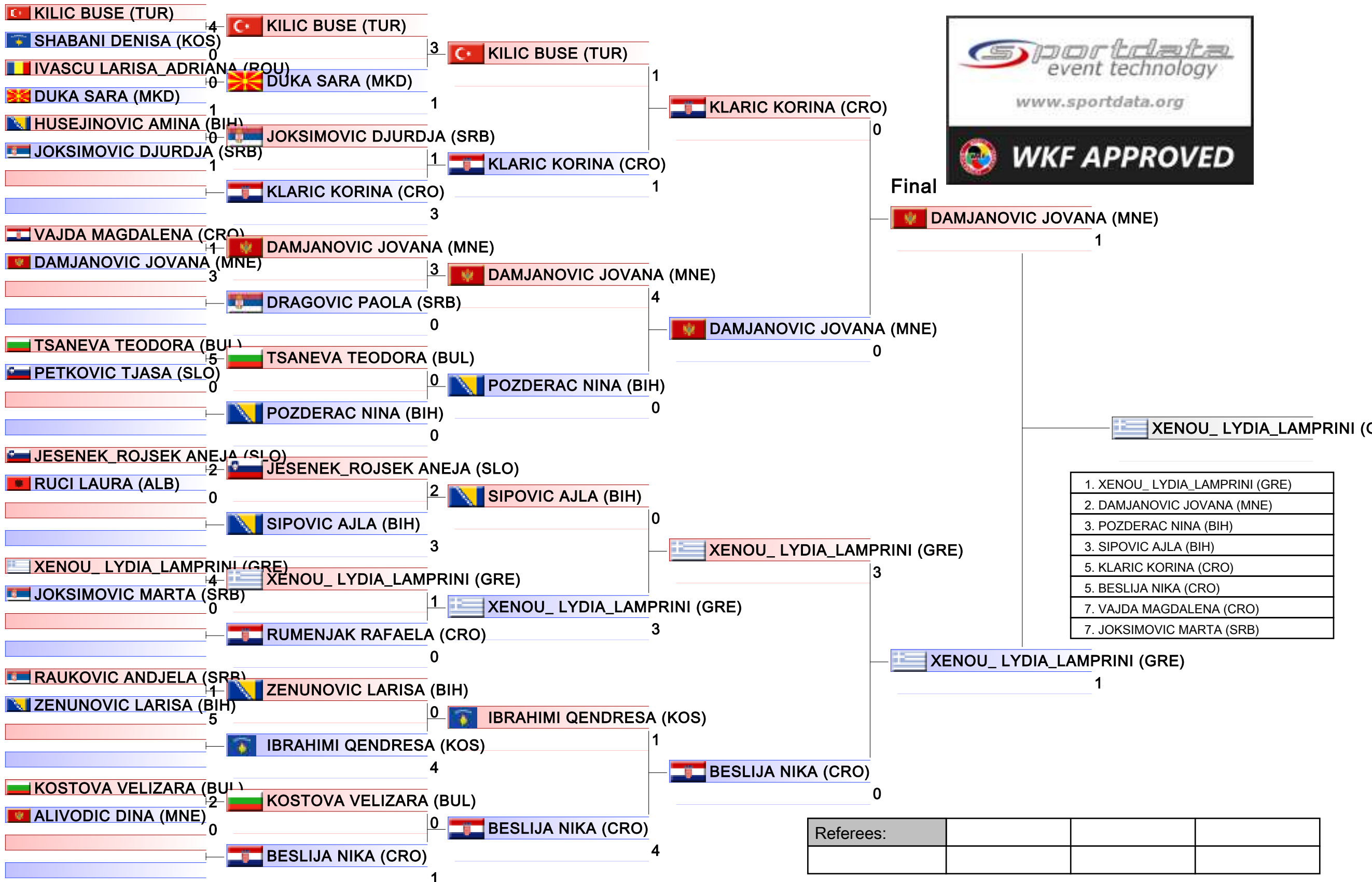

# CADET KUMITE FEMALE -54 KG

21st Balkan Karate Championships for Cadets, Juniors and U21 - RIJEKA 2021

Tatami  
1 12:30

Pool  
1

(c)sportdata GmbH & Co KG 2000-2021(2021-11-29 16:49) -WKF Approved- v 9.8.8 build 3 (2021-11-04) License: SDIL Sportdata Internal License 2021 (expire 2021-12-31)

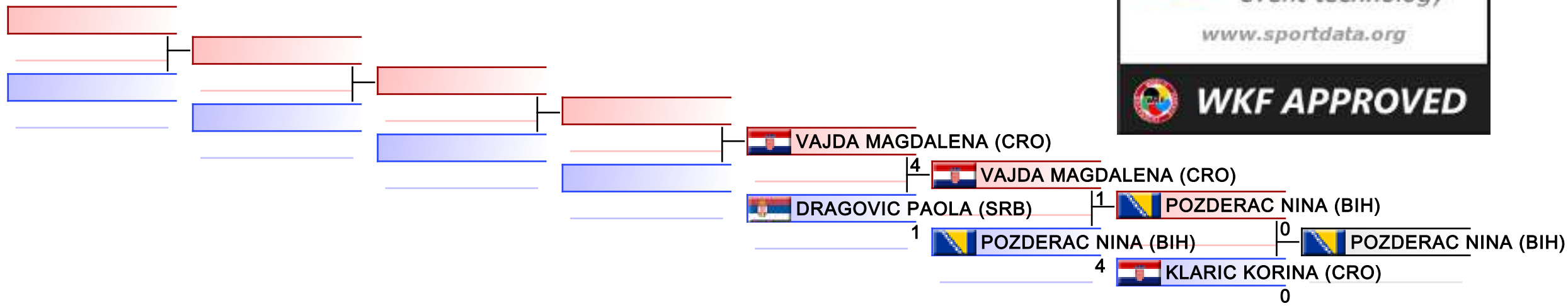

## REPECHAGE: (1)

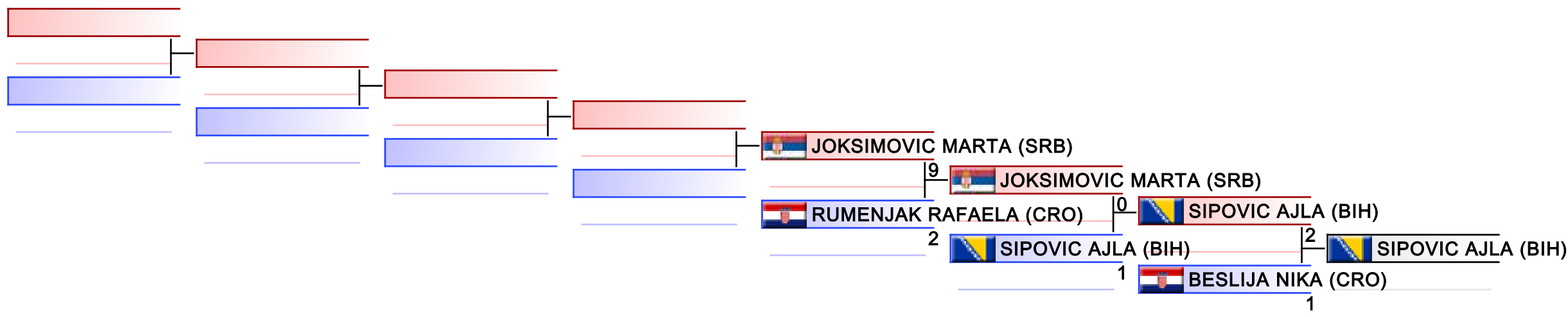

|           |  |  |  |  |  |  |  |
|-----------|--|--|--|--|--|--|--|
| Referees: |  |  |  |  |  |  |  |
|-----------|--|--|--|--|--|--|--|



# CADET KUMITE FEMALE 54+ KG

21st Balkan Karate Championships for Cadets, Juniors and U21 - RIJEKA 2021, RIJEKA, CRO

Tatami  
1 14:10

Pool  
2/2

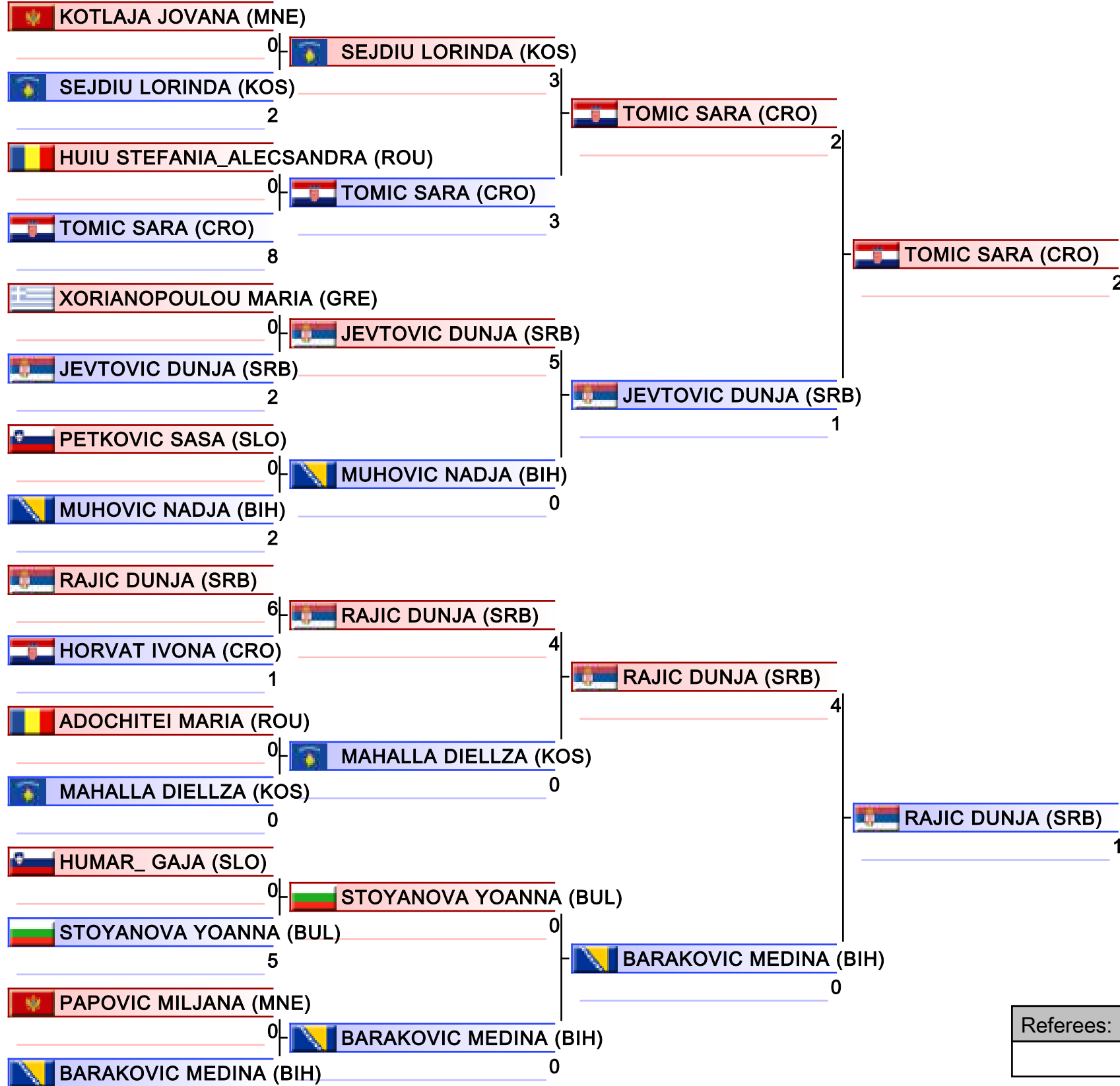

|                                   |
|-----------------------------------|
| 1. TOMIC SARA (CRO)               |
| 2. NIJEMCEVIC_ ANA (SRB)          |
| 3. KALPAKLI IKLIM_SEVVAL (TUR)    |
| 3. RAJIC DUNJA (SRB)              |
| 5. TOPIC KAJA (BIH)               |
| 5. SEJDIU LORINDA (KOS)           |
| 7. ANASTASIOU MARIA_GEORGIA (GRE) |
| 7. JEVTOVIC DUNJA (SRB)           |

|           |  |  |  |
|-----------|--|--|--|
| Referees: |  |  |  |
|           |  |  |  |



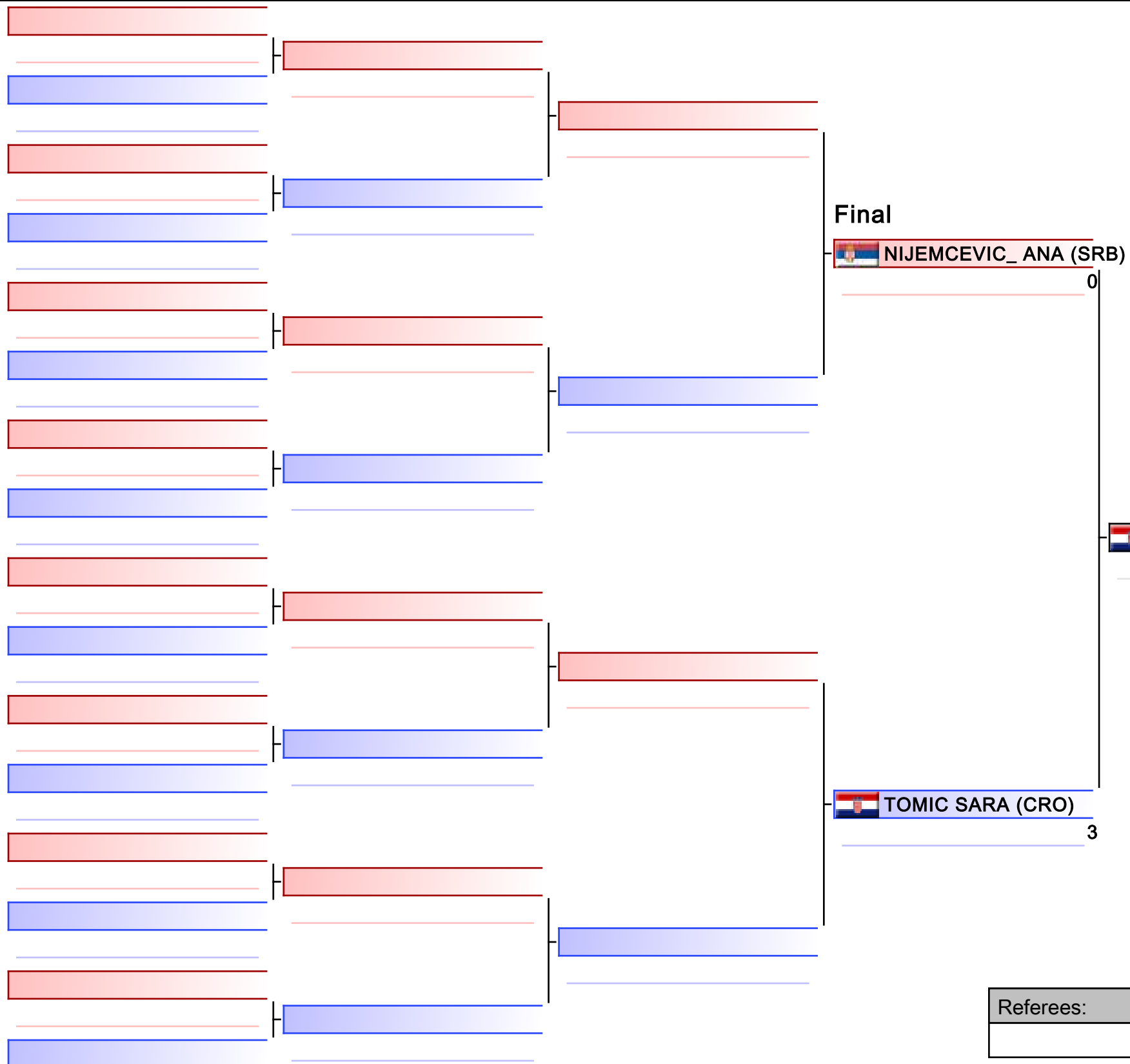

**Final**

NIJEMCEVIC\_ ANA (SRB)

0

TOMIC SARA (CRO)

3

|                                   |
|-----------------------------------|
| 1. TOMIC SARA (CRO)               |
| 2. NIJEMCEVIC_ ANA (SRB)          |
| 3. KALPAKLI IKLIM_SEVVAL (TUR)    |
| 3. RAJIC DUNJA (SRB)              |
| 5. TOPIC KAJA (BIH)               |
| 5. SEJDIU LORINDA (KOS)           |
| 7. ANASTASIOU MARIA_GEORGIA (GRE) |
| 7. JEVTOVIC DUNJA (SRB)           |

|           |  |  |  |
|-----------|--|--|--|
| Referees: |  |  |  |
|           |  |  |  |

# CADET KUMITE FEMALE 54+ KG

21st Balkan Karate Championships for Cadets, Juniors and U21 - RIJEKA 2021

Tatami  
1 15:10

Pool  
1,2

(c)sportdata GmbH & Co KG 2000-2021(2021-11-29 16:49) -WKF Approved- v 9.8.8 build 3 (2021-11-04) License: SDIL Sportdata Internal License 2021 (expire 2021-12-31)

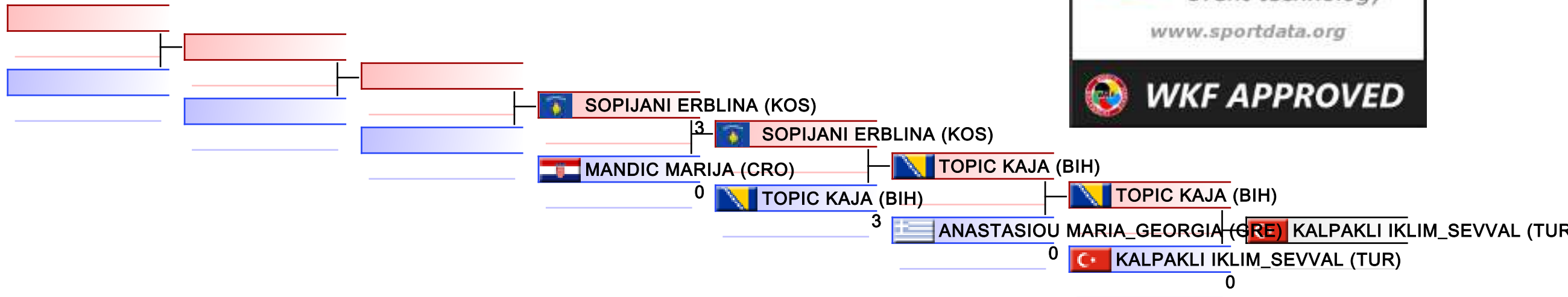

## REPECHAGE: (1,2)

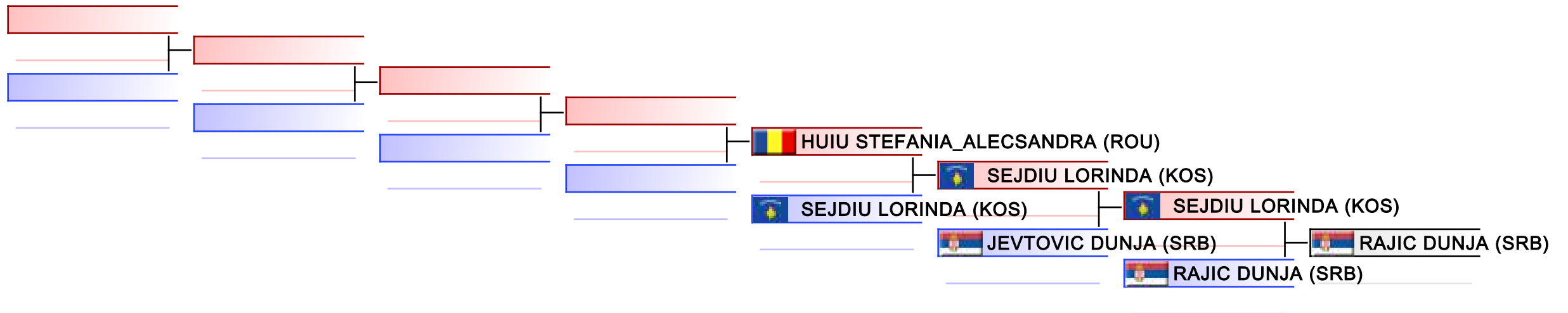

|           |  |  |  |  |  |  |  |
|-----------|--|--|--|--|--|--|--|
| Referees: |  |  |  |  |  |  |  |
|-----------|--|--|--|--|--|--|--|

# CADET KUMITE FEMALE 54+ KG

21st Balkan Karate Championships for Cadets, Juniors and U21 - RIJEKA 2021

Tatami  
1 15:10

Pool  
1

(c)sportdata GmbH & Co KG 2000-2021(2021-11-29 16:49) -WKF Approved- v 9.8.8 build 3 (2021-11-04) License: SDIL Sportdata Internal License 2021 (expire 2021-12-31)

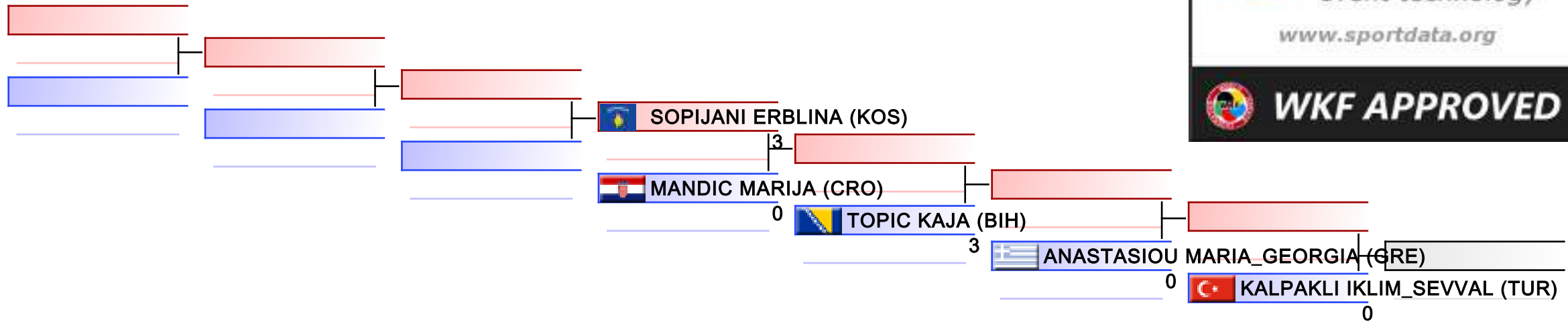

## REPECHAGE: (1)

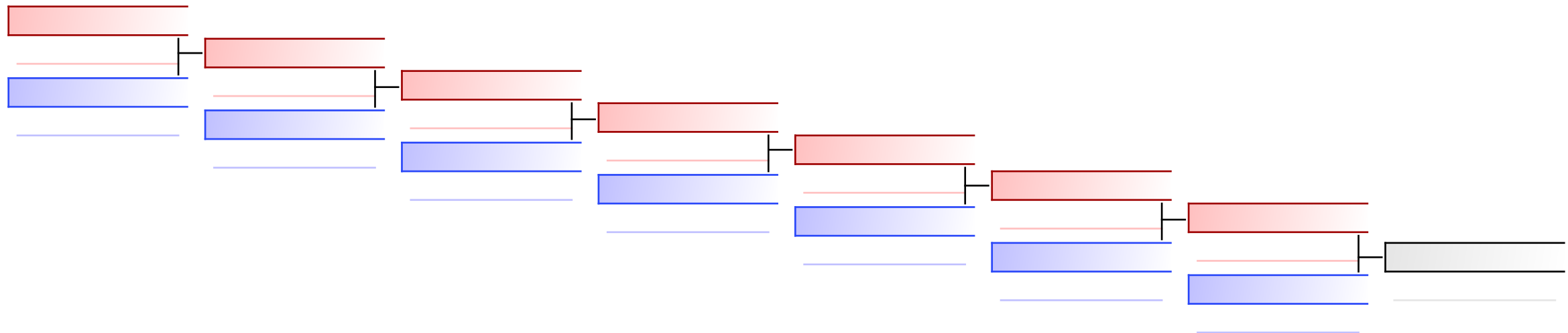

|           |  |  |  |  |  |  |  |
|-----------|--|--|--|--|--|--|--|
| Referees: |  |  |  |  |  |  |  |
|-----------|--|--|--|--|--|--|--|

# CADET KUMITE FEMALE 54+ KG

21st Balkan Karate Championships for Cadets, Juniors and U21 - RIJEKA 2021

Tatami  
1 15:25

Pool  
2

(c)sportdata GmbH & Co KG 2000-2021(2021-11-29 16:49) -WKF Approved- v 9.8.8 build 3 (2021-11-04) License: SDIL Sportdata Internal License 2021 (expire 2021-12-31)

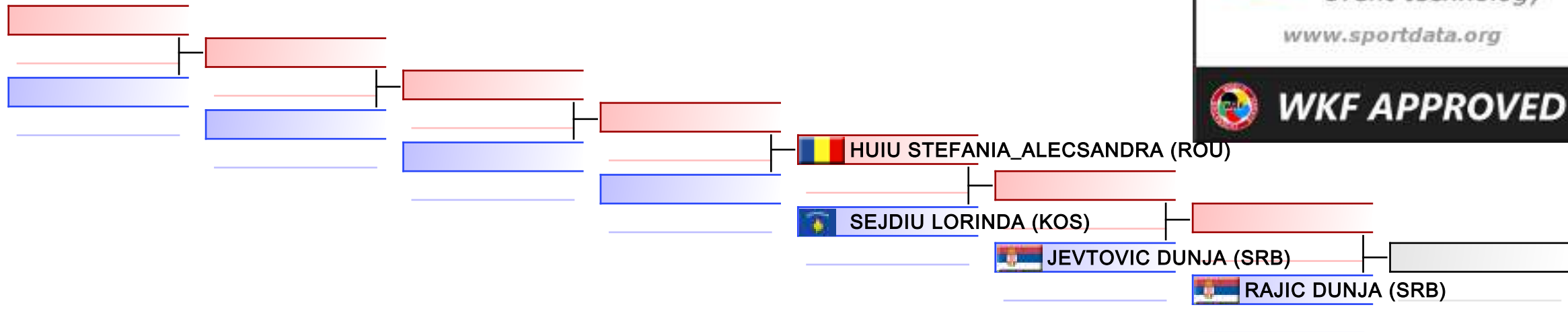

## REPECHAGE: (2)

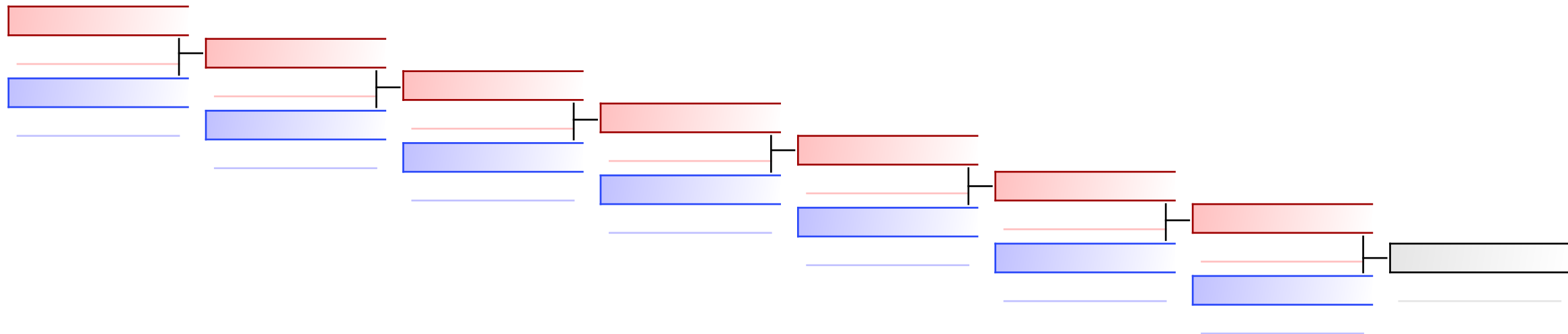

|           |  |  |  |  |  |  |  |
|-----------|--|--|--|--|--|--|--|
| Referees: |  |  |  |  |  |  |  |
|-----------|--|--|--|--|--|--|--|

# CADET KUMITE MALE -52 KG

21st Balkan Karate Championships for Cadets, Juniors and U21 - RIJEKA 2021, RIJEKA, CRO

Tatami  
2 09:00

Pool  
1/1

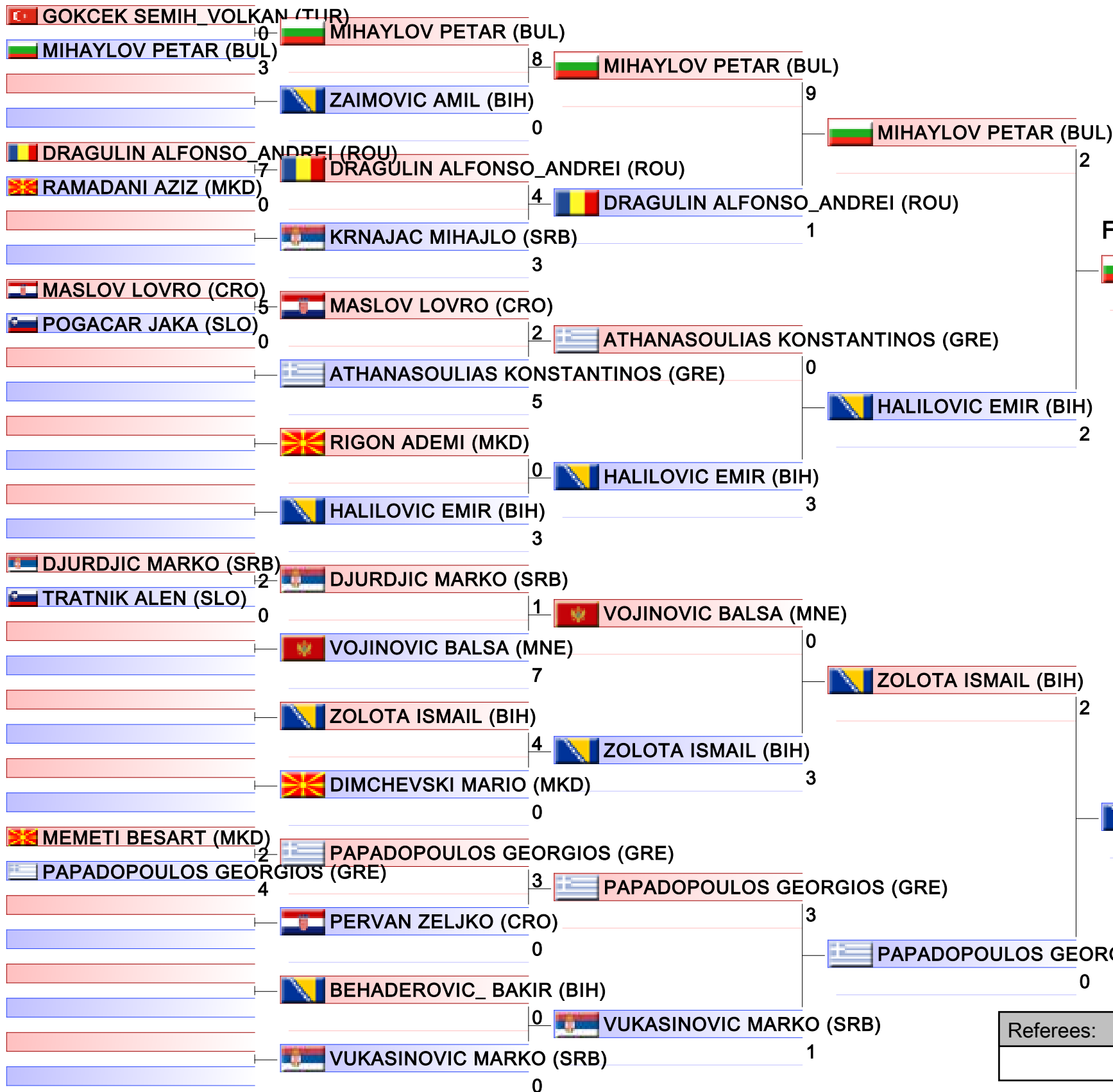

- |                                  |
|----------------------------------|
| 1. ZOLOTA ISMAIL (BIH)           |
| 2. MIHAYLOV PETAR (BUL)          |
| 3. VOJINOVIC Balsa (MNE)         |
| 3. HALILOVIC EMIR (BIH)          |
| 5. PAPADOPOULOS GEORGIOS (GRE)   |
| 5. GOKCEK SEMIH_VOLKAN (TUR)     |
| 7. DIMCHEVSKI MARIO (MKD)        |
| 7. DRAGULIN ALFONSO_ANDREI (ROU) |

|           |  |  |  |
|-----------|--|--|--|
| Referees: |  |  |  |
|           |  |  |  |

# CADET KUMITE MALE -52 KG

21st Balkan Karate Championships for Cadets, Juniors and U21 - RIJEKA 2021

Tatami  
2 10:15

Pool  
1

(c)sportdata GmbH & Co KG 2000-2021(2021-11-29 16:49) -WKF Approved- v 9.8.8 build 3 (2021-11-04) License: SDIL Sportdata Internal License 2021 (expire 2021-12-31)

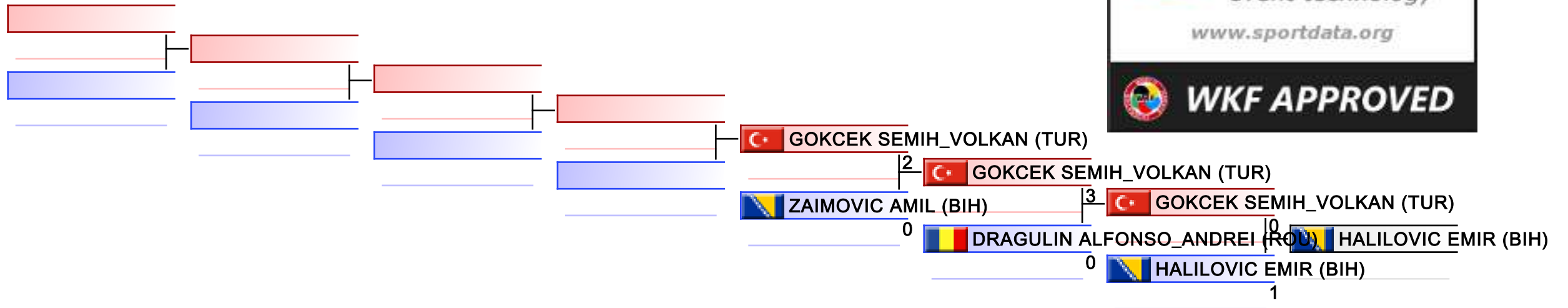

## REPECHAGE: (1)

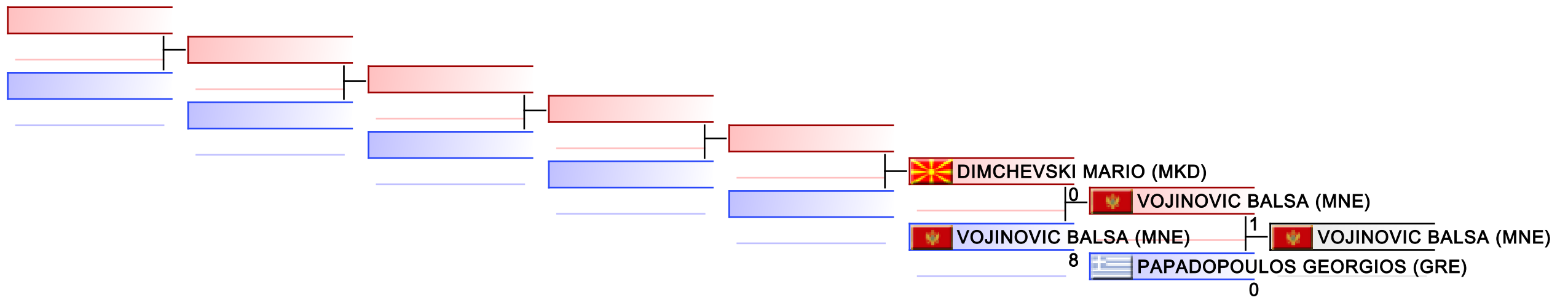

|           |  |  |  |  |  |  |  |
|-----------|--|--|--|--|--|--|--|
| Referees: |  |  |  |  |  |  |  |
|-----------|--|--|--|--|--|--|--|

# CADET KUMITE MALE -57 KG

21st Balkan Karate Championships for Cadets, Juniors and U21 - RIJEKA 2021, RIJEKA, CRO

Tatami  
2 10:50

Pool  
1/1

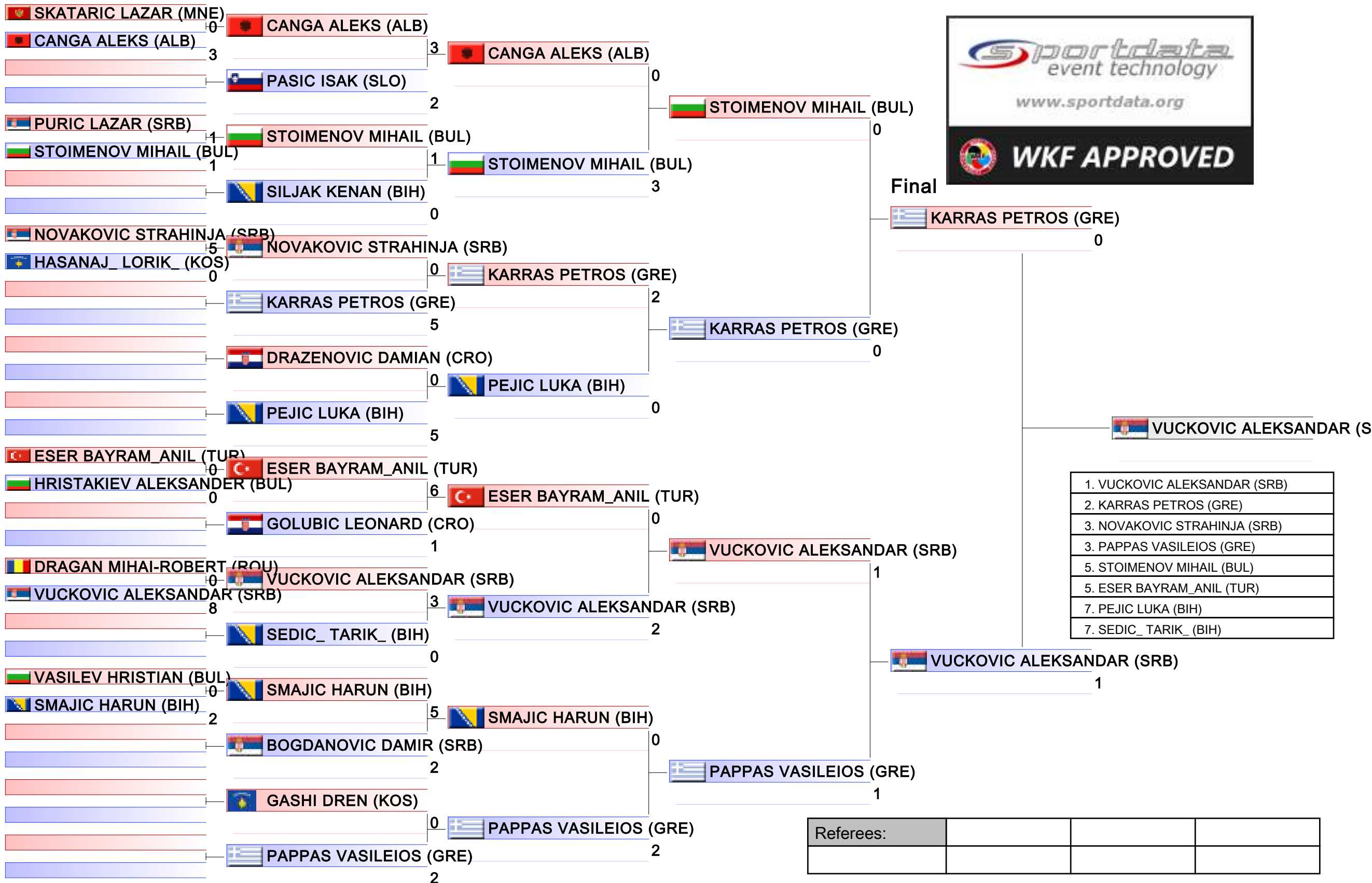

# CADET KUMITE MALE -57 KG

21st Balkan Karate Championships for Cadets, Juniors and U21 - RIJEKA 2021

Tatami  
2 12:10

Pool  
1

(c)sportdata GmbH & Co KG 2000-2021(2021-11-29 16:49) -WKF Approved- v 9.8.8 build 3 (2021-11-04) License: SDIL Sportdata Internal License 2021 (expire 2021-12-31)

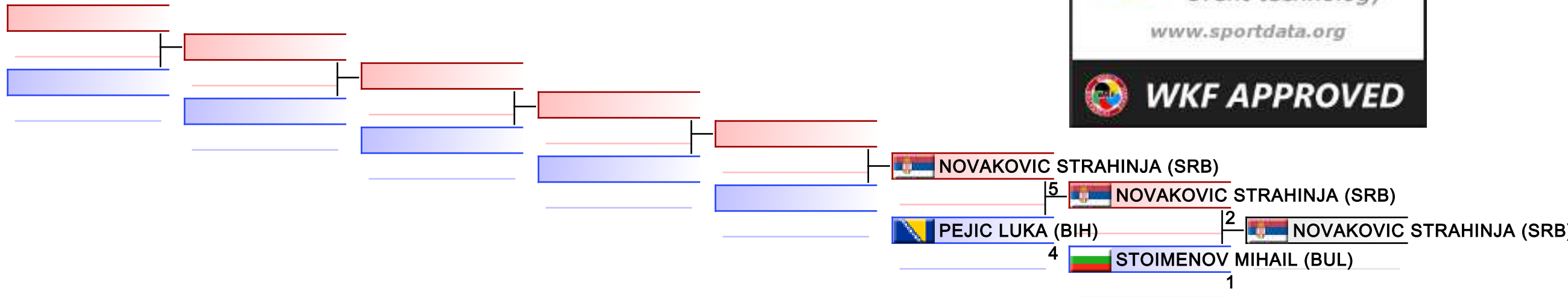

## REPECHAGE: (1)

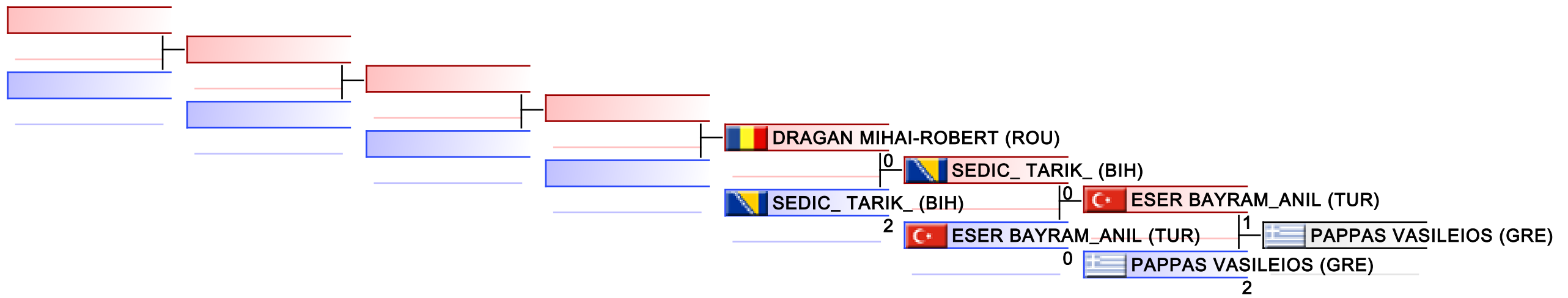

|           |  |  |  |  |  |  |  |
|-----------|--|--|--|--|--|--|--|
| Referees: |  |  |  |  |  |  |  |
|-----------|--|--|--|--|--|--|--|



# CADET KUMITE MALE -63 KG

21st Balkan Karate Championships for Cadets, Juniors and U21 - RIJEKA 2021, RIJEKA, CRO

Tatami  
2 12:45

Pool  
1/1

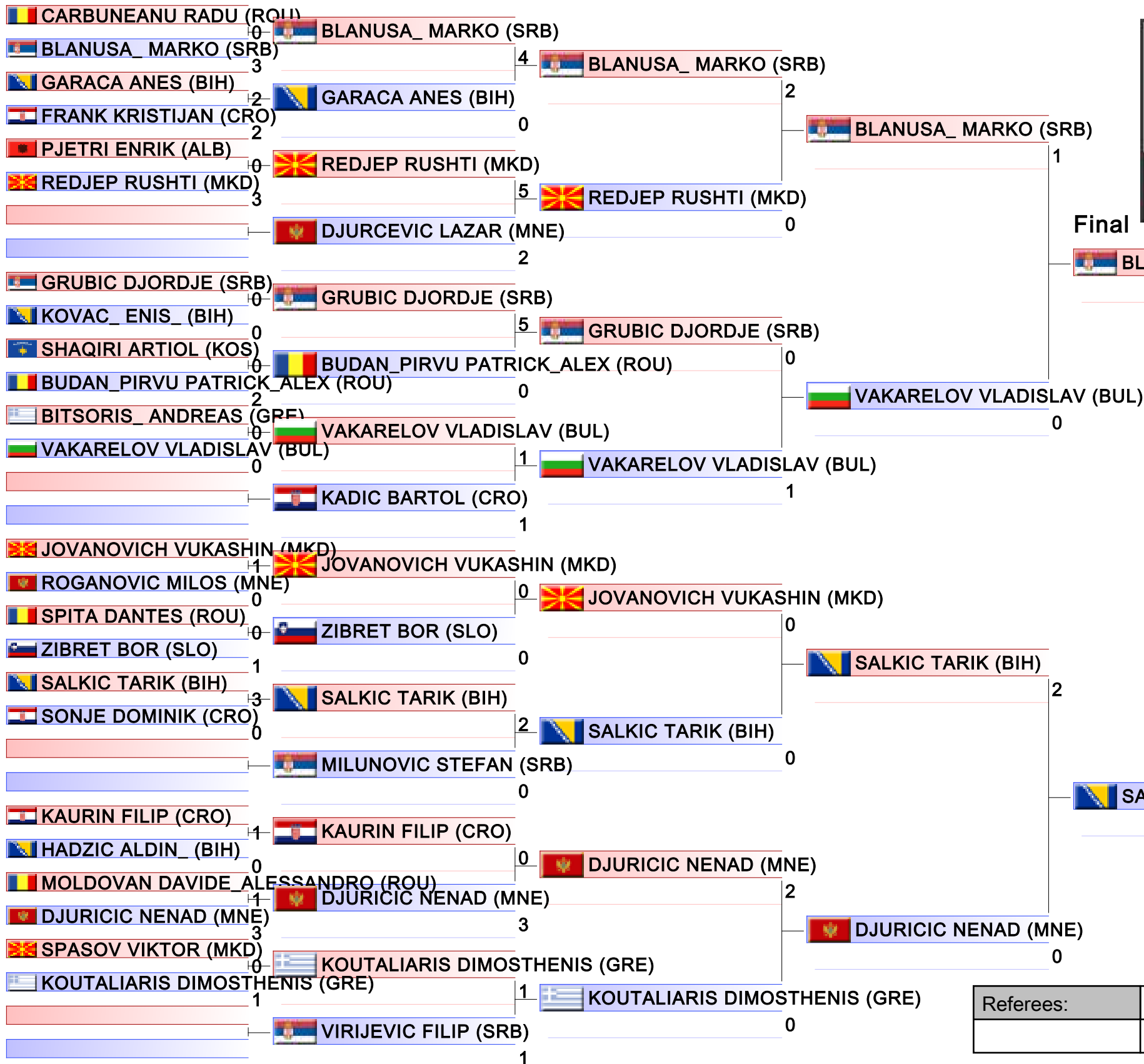

|                              |
|------------------------------|
| 1. SALKIC_TARIK (BIH)        |
| 2. BLANUSA_MARKO (SRB)       |
| 3. REDJEP_RUSHTI (MKD)       |
| 3. DJURICIC_NENAD (MNE)      |
| 5. VAKARELOV_VLADISLAV (BUL) |
| 5. MILUNOVIC_STEFAN (SRB)    |
| 7. GARACA_ANES (BIH)         |
| 7. JOVANOVIK_VUKASHIN (MKD)  |

|           |  |  |  |
|-----------|--|--|--|
| Referees: |  |  |  |
|           |  |  |  |

# CADET KUMITE MALE -63 KG

21st Balkan Karate Championships for Cadets, Juniors and U21 - RIJEKA 2021

Tatami  
2 14:30

Pool  
1

(c)sportdata GmbH & Co KG 2000-2021(2021-11-29 16:49) -WKF Approved- v 9.8.8 build 3 (2021-11-04) License: SDIL Sportdata Internal License 2021 (expire 2021-12-31)

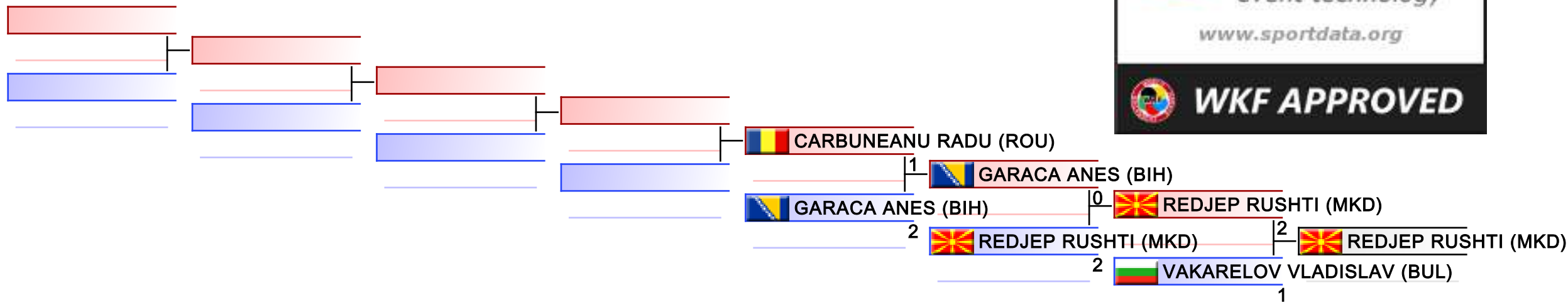

## REPECHAGE: (1)

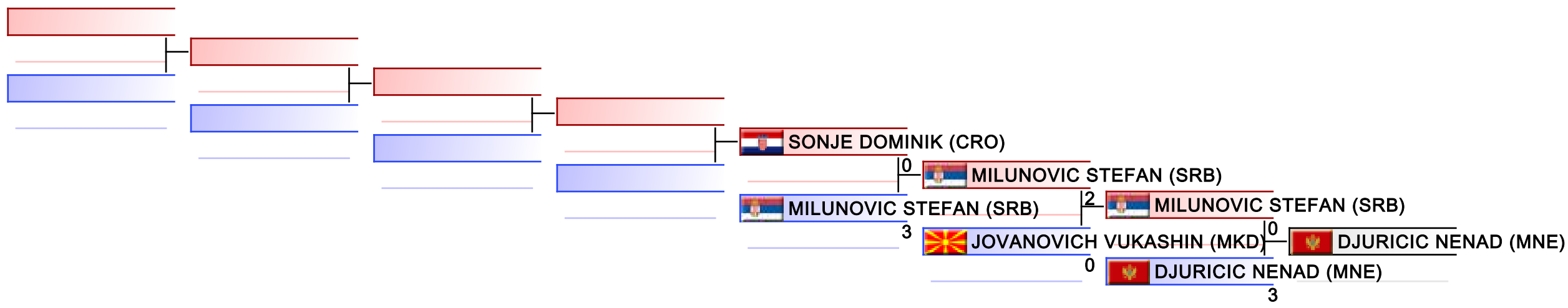

|           |  |  |  |  |  |  |  |
|-----------|--|--|--|--|--|--|--|
| Referees: |  |  |  |  |  |  |  |
|-----------|--|--|--|--|--|--|--|

# CADET KUMITE MALE -70 KG

21st Balkan Karate Championships for Cadets, Juniors and U21 - RIJEKA 2021, RIJEKA, CRO

Tatami  
2 09:35

Pool  
1/1

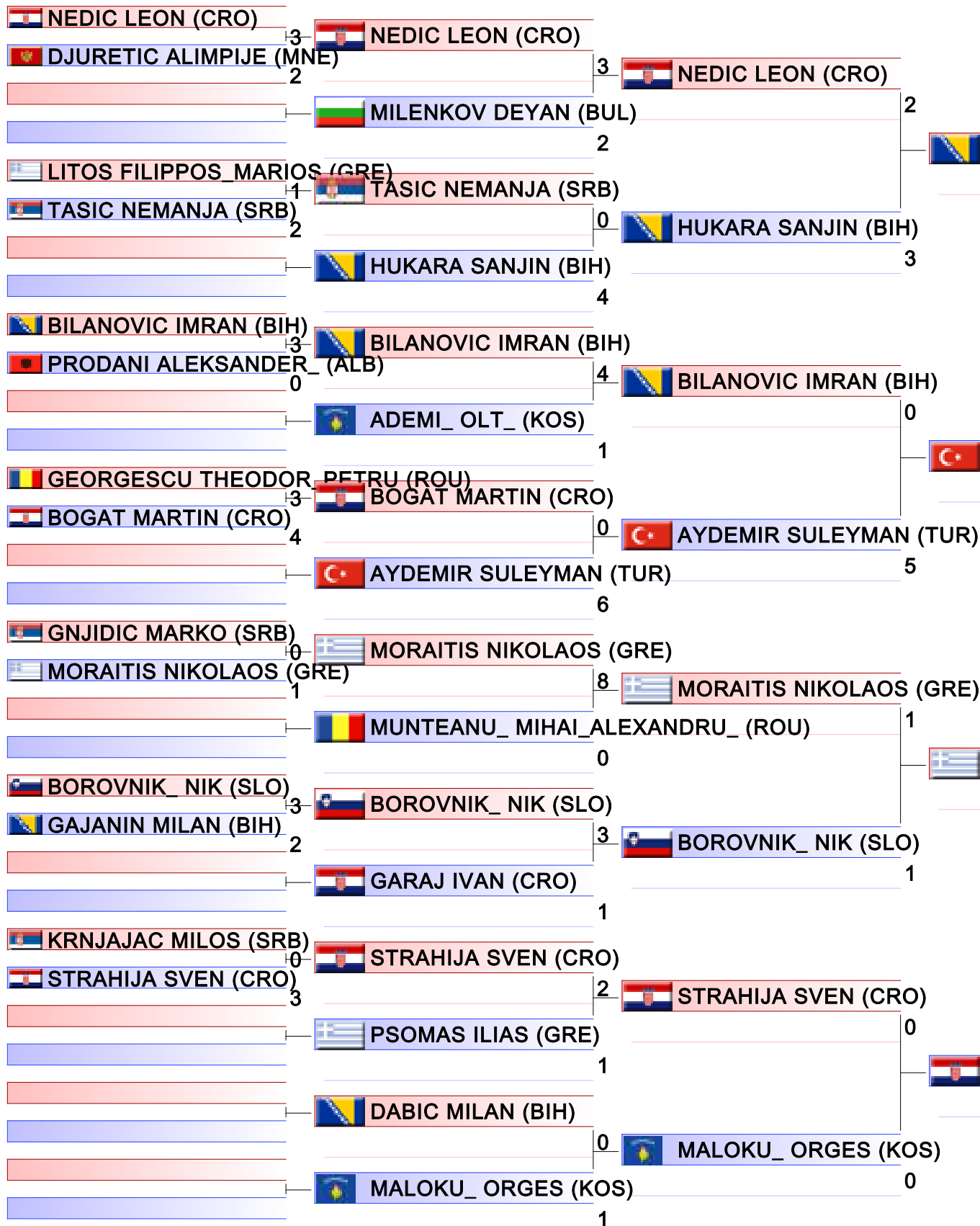

Final

|                            |
|----------------------------|
| 1. HUKARA SANJIN (BIH)     |
| 2. STRAHIJA SVEN (CRO)     |
| 3. PSOMAS ILIAS (GRE)      |
| 3. AYDEMIR SULEYMAN (TUR)  |
| 5. MORAITIS NIKOLAOS (GRE) |
| 5. TASIC NEMANJA (SRB)     |
| 7. MALOKU_ORGES (KOS)      |
| 7. NEDIC LEON (CRO)        |

|           |  |  |  |
|-----------|--|--|--|
| Referees: |  |  |  |
|           |  |  |  |

# CADET KUMITE MALE -70 KG

21st Balkan Karate Championships for Cadets, Juniors and U21 - RIJEKA 2021

Tatami  
2 11:00

Pool  
1

(c)sportdata GmbH & Co KG 2000-2021(2021-11-29 16:49) -WKF Approved- v 9.8.8 build 3 (2021-11-04) License: SDIL Sportdata Internal License 2021 (expire 2021-12-31)

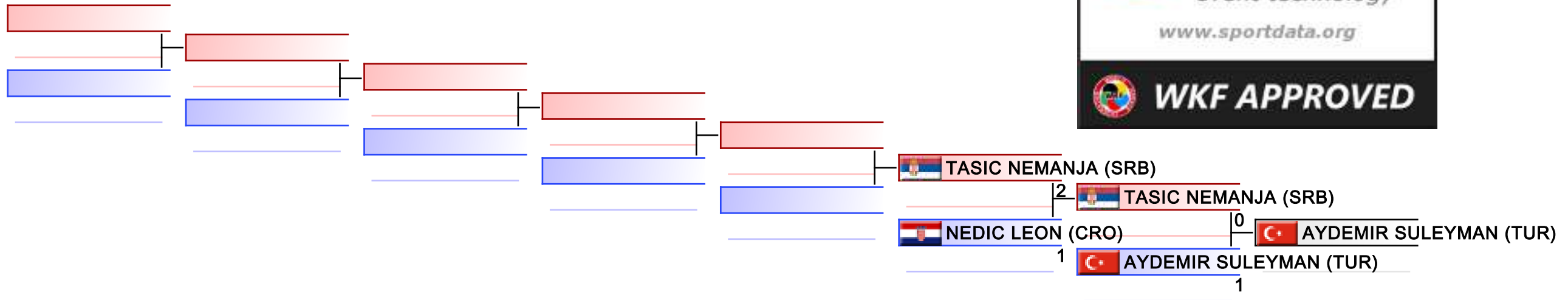

## REPECHAGE: (1)

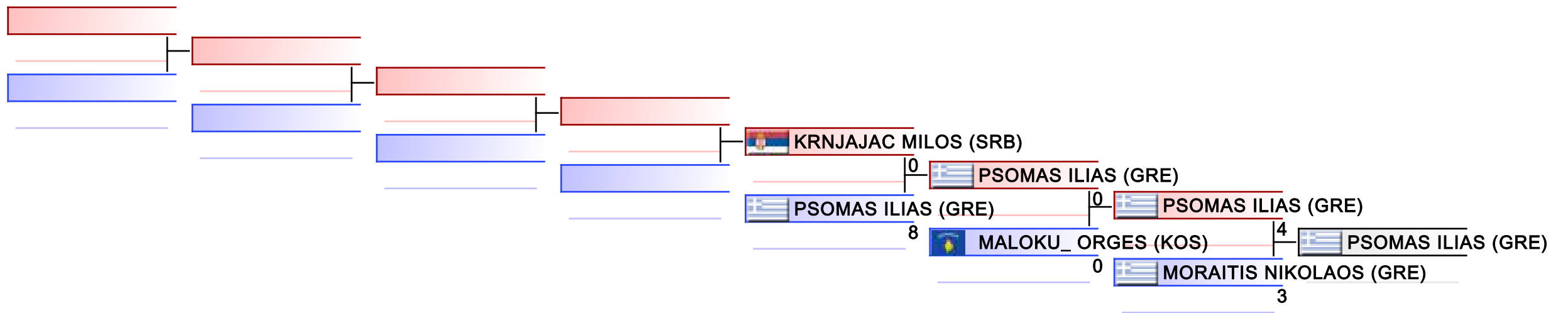

|           |  |  |  |  |  |  |  |
|-----------|--|--|--|--|--|--|--|
| Referees: |  |  |  |  |  |  |  |
|-----------|--|--|--|--|--|--|--|

# CADET KUMITE MALE 70+ KG

21st Balkan Karate Championships for Cadets, Juniors and U21 - RIJEKA 2021, RIJEKA, CRO

Tatami  
6 12:40

Pool  
1/1

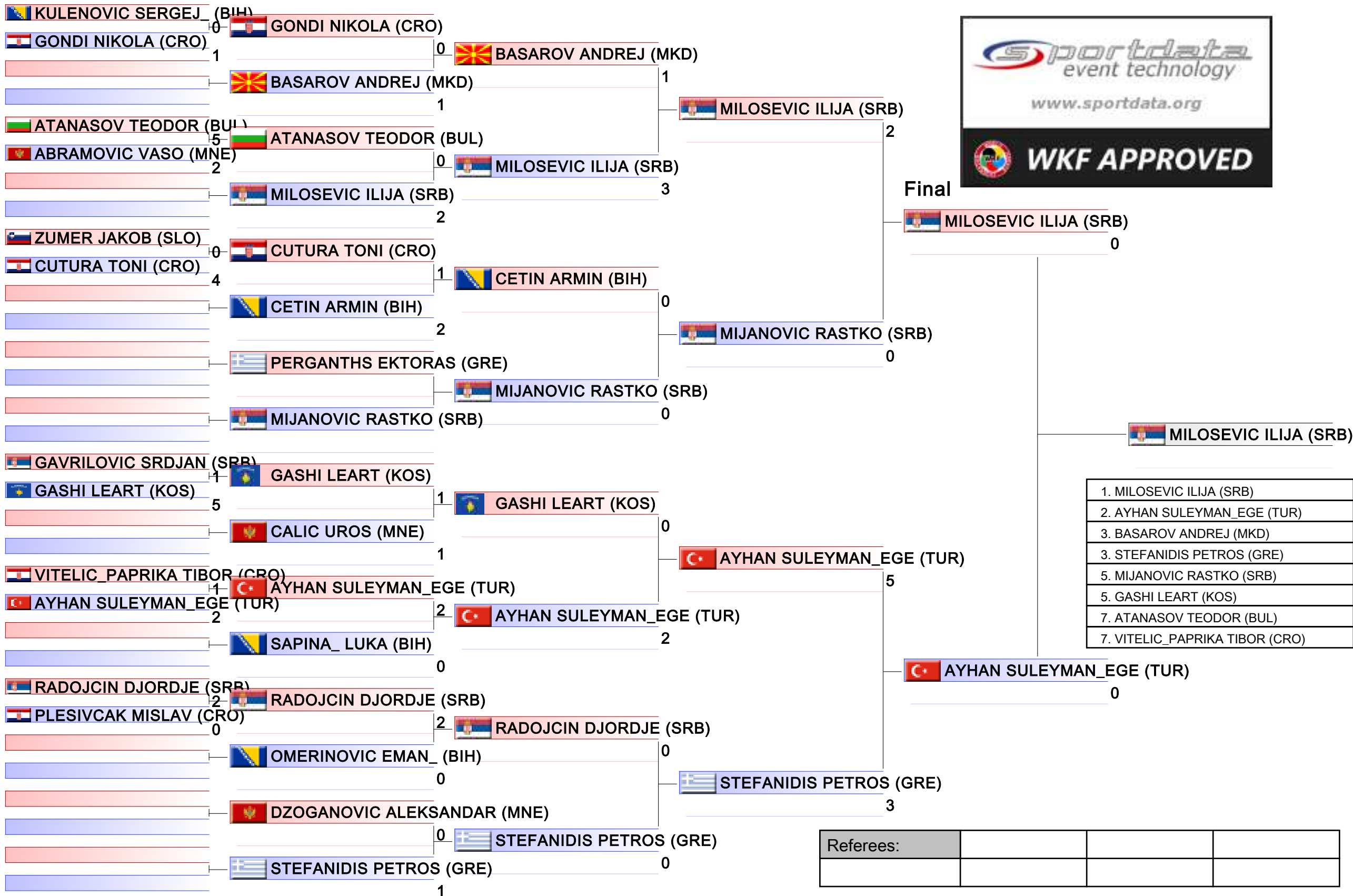

# CADET KUMITE MALE 70+ KG

21st Balkan Karate Championships for Cadets, Juniors and U21 - RIJEKA 2021

Tatami  
6 14:00

Pool  
1

(c)sportdata GmbH & Co KG 2000-2021(2021-11-29 16:49) -WKF Approved- v 9.8.8 build 3 (2021-11-04) License: SDIL Sportdata Internal License 2021 (expire 2021-12-31)

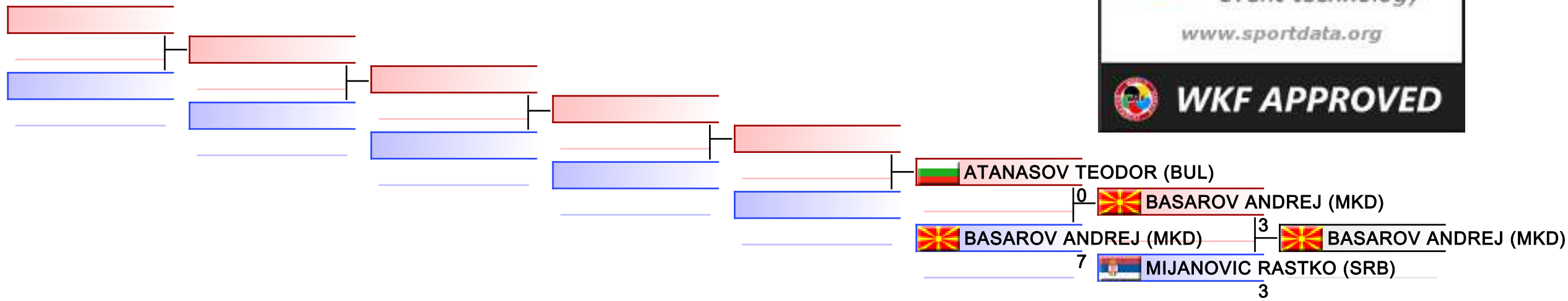

## REPECHAGE: (1)

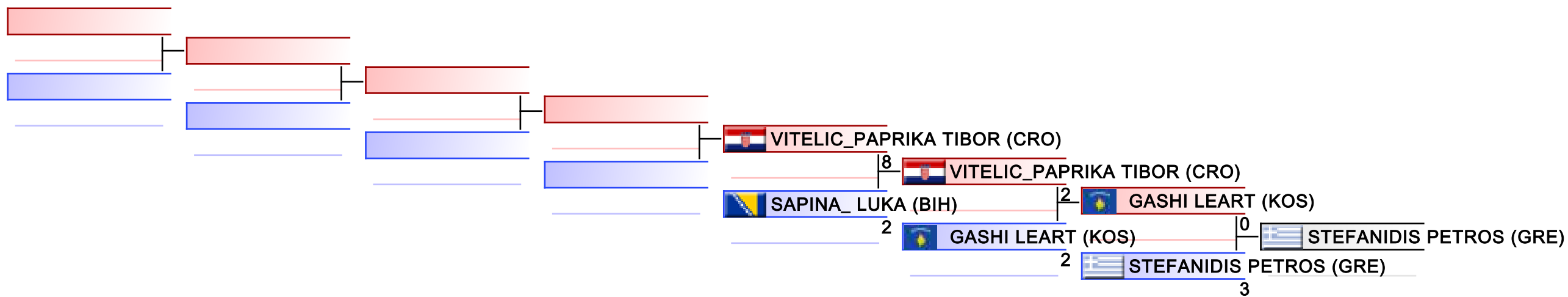

|           |  |  |  |  |  |  |  |
|-----------|--|--|--|--|--|--|--|
| Referees: |  |  |  |  |  |  |  |
|-----------|--|--|--|--|--|--|--|



# CADET KUMITE TEAM FEMALE

21st Balkan Karate Championships for Cadets, Juniors and U21 - RIJEKA 2021, RIJEKA, CRO

Tatami  
1 09:35

Pool  
1/1

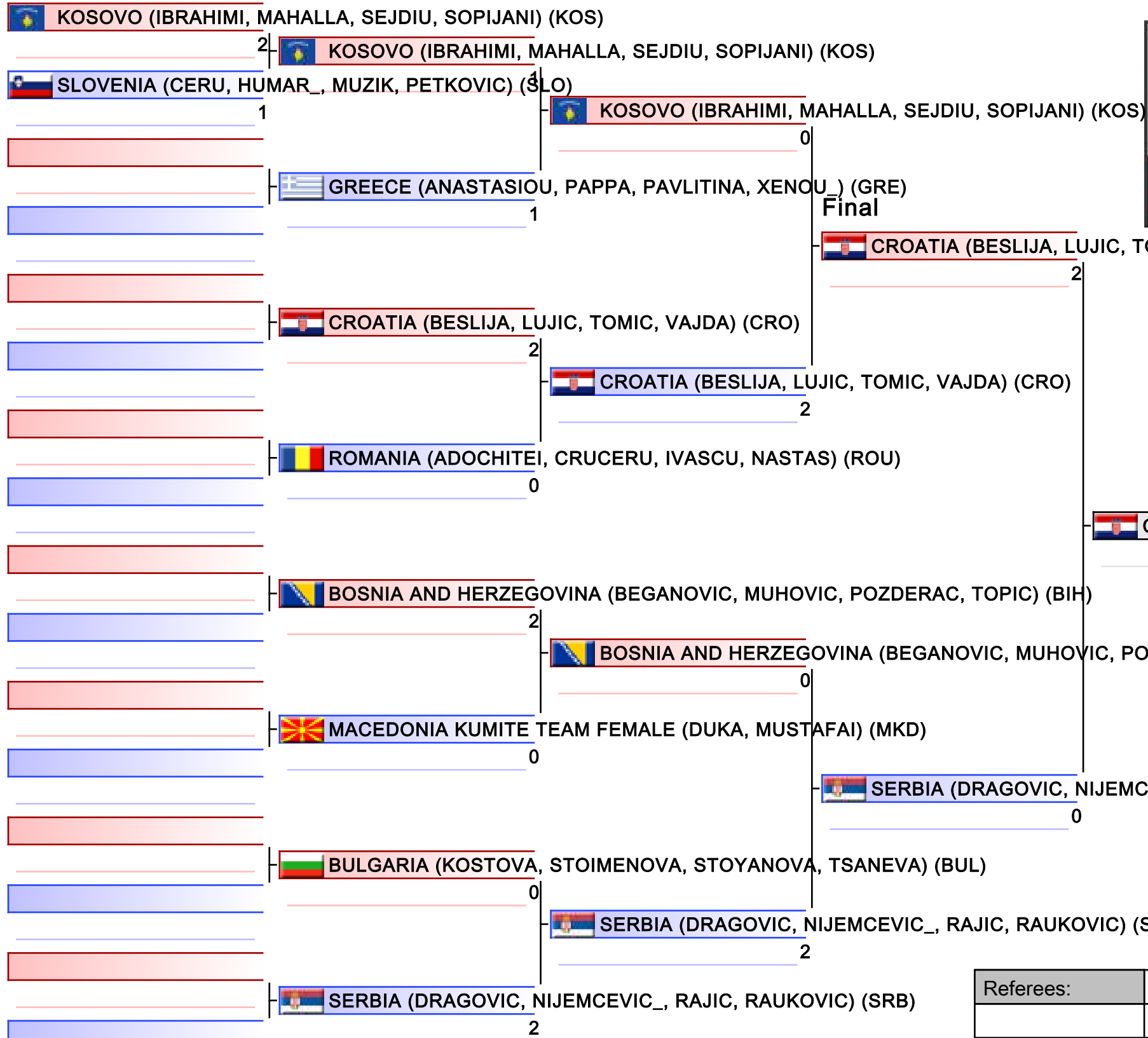

|                                 |
|---------------------------------|
| 1. CROATIA (CRO)                |
| 2. SERBIA (SRB)                 |
| 3. ROMANIA (ROU)                |
| 3. BULGARIA (BUL)               |
| 5. KOSOVO (KOS)                 |
| 5. BOSNIA AND HERZEGOVINA (BIH) |
|                                 |
|                                 |

|           |  |  |  |
|-----------|--|--|--|
| Referees: |  |  |  |
|           |  |  |  |

# CADET KUMITE TEAM FEMALE

21st Balkan Karate Championships for Cadets, Juniors and U21 - RIJEKA 2021

Tatami  
1 11:55

Pool  
1

(c)sportdata GmbH & Co KG 2000-2021(2021-11-29 16:49) -WKF Approved- v 9.8.8 build 3 (2021-11-04) License: SDIL Sportdata Internal License 2021 (expire 2021-12-31)

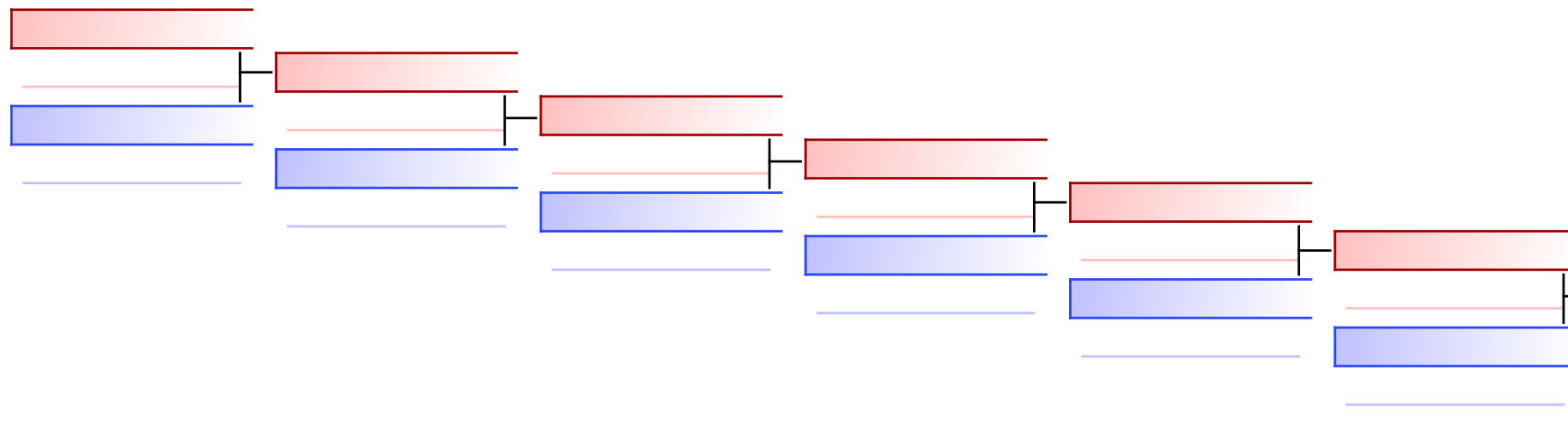

ROMANIA (ADOCHITEI, CRUCERU, IVASCU, NASTASE) 2  
 ROMANIA (ADOCHITEI, CRUCERU, IVASCU, NASTASE) 2  
 KOSOVO (IBRAHIMI, MAHALLA, SEJDIU, SOPIJANI) 1

## REPECHAGE: (1)

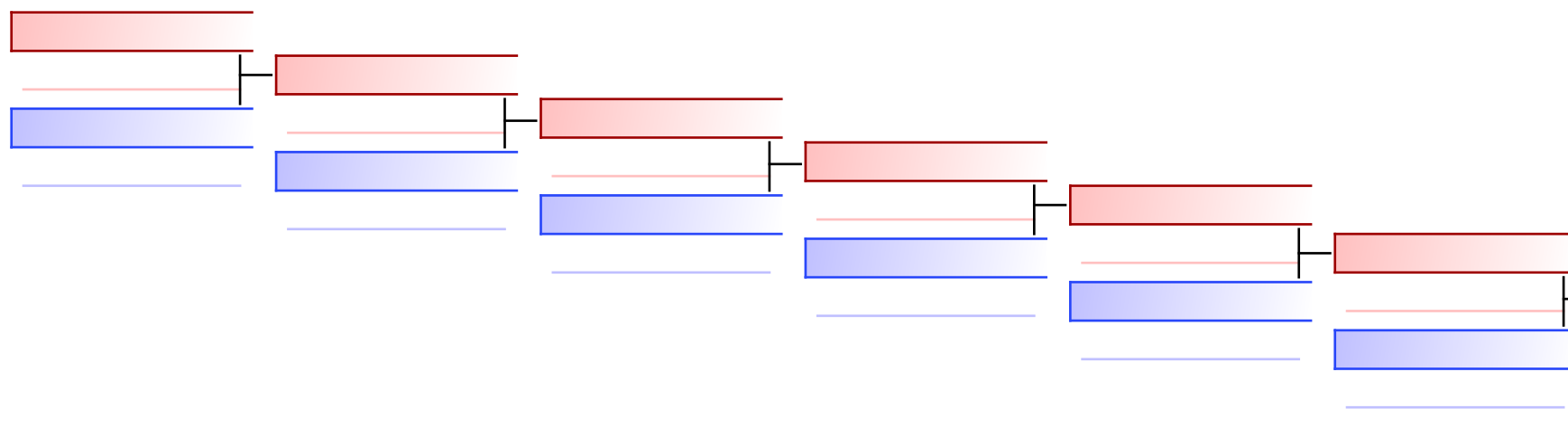

BULGARIA (KOSTOVA, STOIMENOVA, STOYANOVA) 2  
 BULGARIA (KOSTOVA, STOIMENOVA, STOYANOVA) 2  
 BOSNIA AND HERZEGOVINA (BEGANOVIC, MUHOVIC) 0

|           |  |  |  |  |  |  |  |
|-----------|--|--|--|--|--|--|--|
| Referees: |  |  |  |  |  |  |  |
|-----------|--|--|--|--|--|--|--|



# CADET KUMITE TEAM MALE

21st Balkan Karate Championships for Cadets, Juniors and U21 - RIJEKA 2021, RIJEKA, CRO

Tatami  
1 09:00

Pool  
1/1

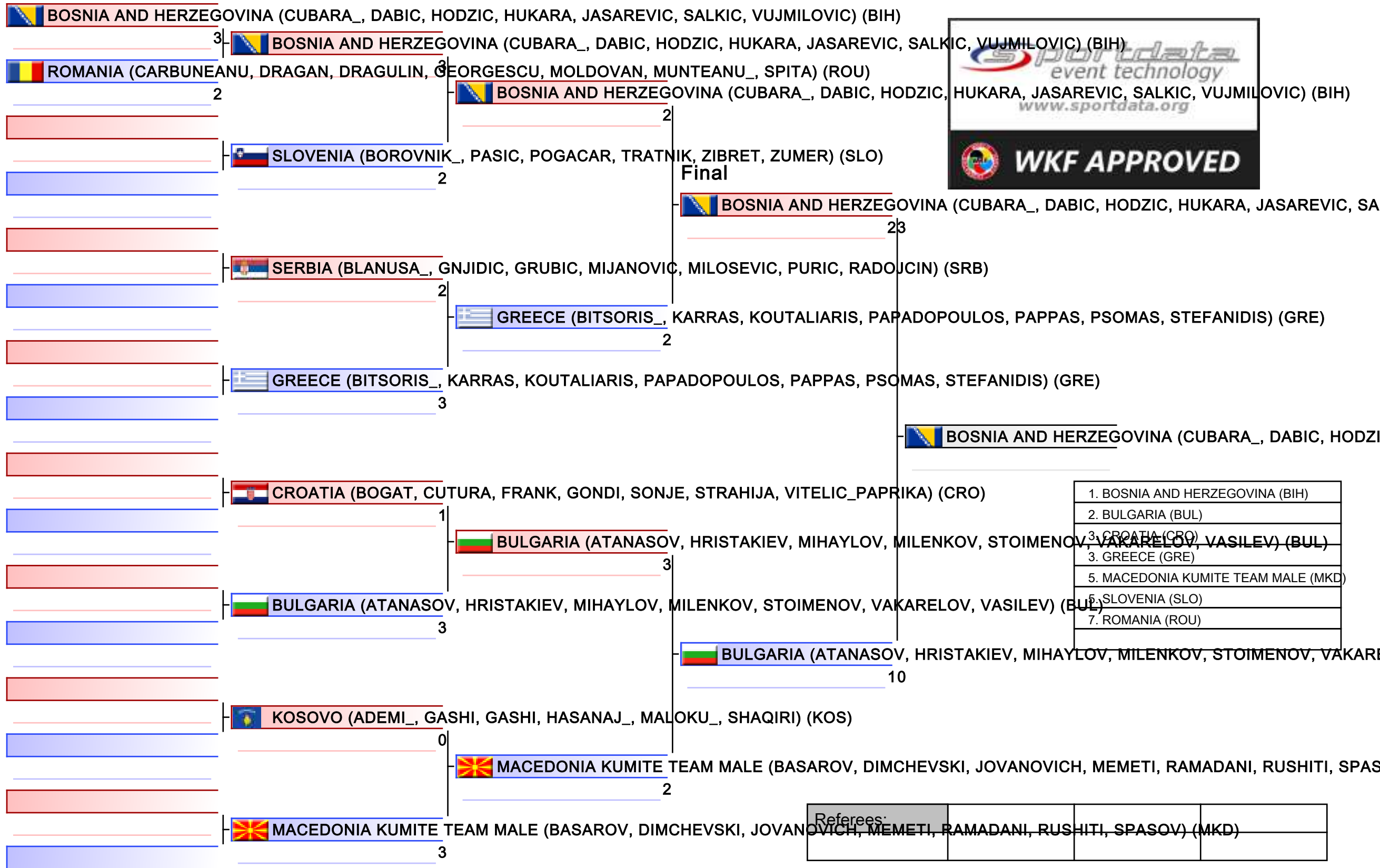

# CADET KUMITE TEAM MALE

21st Balkan Karate Championships for Cadets, Juniors and U21 - RIJEKA 2021

Tatami  
1 11:55

Pool  
1

(c)sportdata GmbH & Co KG 2000-2021(2021-11-29 16:49) -WKF Approved- v 9.8.8 build 3 (2021-11-04) License: SDIL Sportdata Internal License 2021 (expire 2021-12-31)

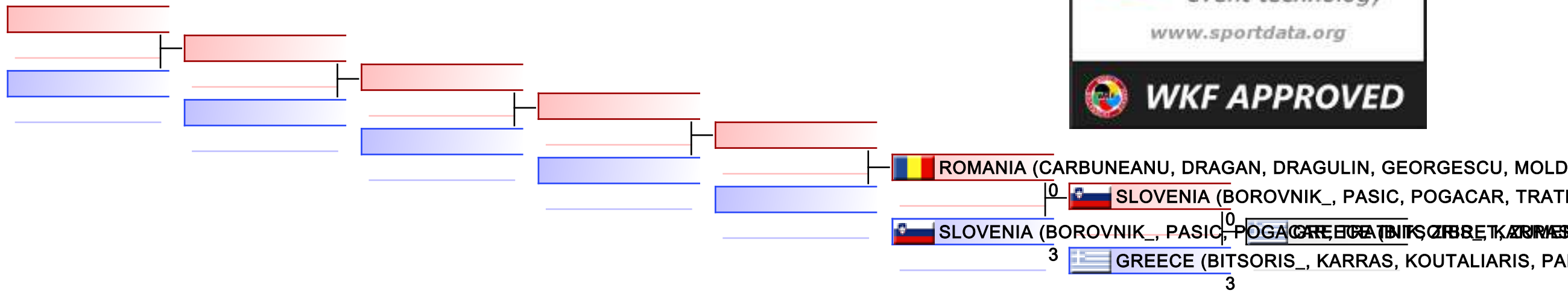

## REPECHAGE: (1)

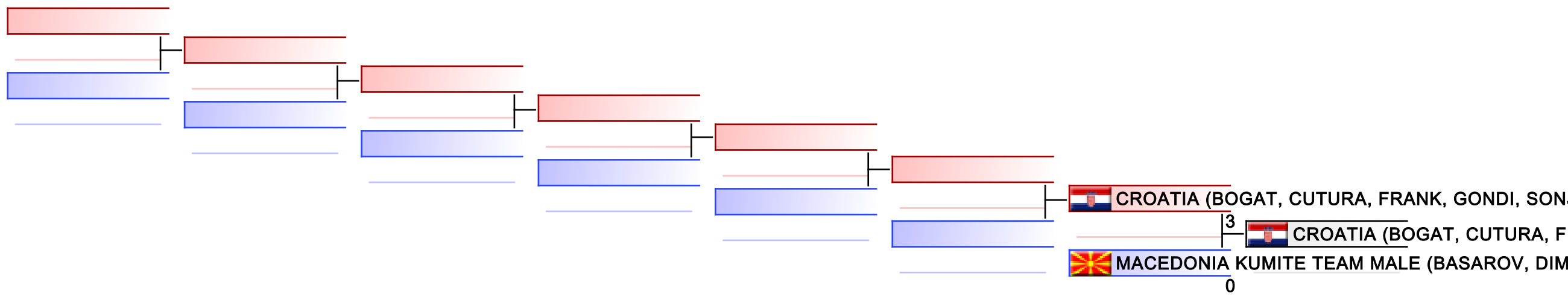

|           |  |  |  |  |  |  |  |
|-----------|--|--|--|--|--|--|--|
| Referees: |  |  |  |  |  |  |  |
|-----------|--|--|--|--|--|--|--|

**21st Balkan Karate Championships for Cadets,  
Juniors and U21 - RIJEKA 2021 - 2021-11-26**

**Junior Kata Female**

**R1 G1/4 (7) Tatami 5 09:35**

| Competitors                    | Kata              | 1T    | 1A    | 2T    | 2A    | 3T    | 3A    | 4T    | 4A    | 5T  | 5A    | 6T | 6A | 7T | 7A | TEC   | ATH  | Extra | Total | Rank |
|--------------------------------|-------------------|-------|-------|-------|-------|-------|-------|-------|-------|-----|-------|----|----|----|----|-------|------|-------|-------|------|
| 1 ARSOVSKA MARTINA (MKD)       | 092 SUPARINPEI    | 7.6   | 7.8   | 7.8   | 7.6   | (8.6) | (8.8) | (7.2) | (7.2) | 7.8 | 7.8   |    |    |    |    | 16.24 | 6.96 |       | 23.2  | 2    |
| 2 KUTIJA ALJA (SLO)            | 020 GOJUSHIHO DAI | (6.8) | (7.0) | 7.4   | 7.2   | (8.0) | (8.0) | 7.6   | 7.2   | 7.4 | 7.0   |    |    |    |    | 15.68 | 6.42 |       | 22.1  | 4    |
| 3 RADOVANOVIC ALEKSANDRA (SRB) | 020 GOJUSHIHO DAI | (6.6) | (6.8) | 7.0   | 6.8   | (7.8) | (7.6) | 7.8   | 7.6   | 7.2 | 7.2   |    |    |    |    | 15.4  | 6.48 |       | 21.88 | 5    |
| 4 KOKKOTA ANASTASIA (GRE)      | 099 UNSU          | (6.0) | (6.2) | 6.8   | 6.6   | (7.4) | (7.2) | 6.8   | 6.8   | 6.8 | 6.8   |    |    |    |    | 14.28 | 6.06 |       | 20.34 | 7    |
| 5 DURAKOVIC SEJMA (BIH)        | 021 GOJUSHIHO SHO | 7.0   | 6.8   | (6.4) | (6.4) | (7.6) | (7.8) | 7.0   | 6.6   | 7.0 | 7.2   |    |    |    |    | 14.7  | 6.18 |       | 20.88 | 6    |
| 6 BRAJA KLARA (CRO)            | 030 HEIKU         | (7.2) | (7.4) | 7.6   | 7.6   | (8.8) | (8.8) | 8.0   | 7.6   | 8.4 | 8.4   |    |    |    |    | 16.8  | 7.08 |       | 23.88 | 1    |
| 7 ASLI PEHLIVAN (TUR)          | 020 GOJUSHIHO DAI | 7.4   | (7.2) | (7.2) | 7.2   | (8.2) | 7.8   | 7.6   | 7.6   | 8.2 | (8.2) |    |    |    |    | 16.24 | 6.78 |       | 23.02 | 3    |

**R1 G2/4 (6) Tatami 5 10:10**

| Competitors               | Kata                    | 1T    | 1A    | 2T    | 2A  | 3T    | 3A    | 4T    | 4A    | 5T    | 5A    | 6T | 6A | 7T | 7A | TEC   | ATH  | Extra | Total | Rank |
|---------------------------|-------------------------|-------|-------|-------|-----|-------|-------|-------|-------|-------|-------|----|----|----|----|-------|------|-------|-------|------|
| 1 TUREMEN DAMLA_SU (TUR)  | 021 GOJUSHIHO SHO       | (8.8) | (9.0) | 8.6   | 8.4 | 8.2   | 8.4   | 8.4   | 8.4   | (7.6) | (7.8) |    |    |    |    | 17.64 | 7.56 |       | 25.2  | 1    |
| 2 BANEASU MICHELLE (ROU)  | 008 CHATANYARA KUSHANKU | (7.8) | (7.6) | 6.8   | 6.6 | 7.4   | 7.2   | (6.2) | (6.0) | 6.6   | 6.8   |    |    |    |    | 14.56 | 6.18 |       | 20.74 | 6    |
| 3 MARKOVIC MILA (MNE)     | 020 GOJUSHIHO DAI       | (8.0) | (8.0) | 7.6   | 7.4 | 7.6   | 7.8   | (7.2) | (7.0) | 7.2   | 7.0   |    |    |    |    | 15.68 | 6.66 |       | 22.34 | 4    |
| 4 ARIFI ENKELA (KOS)      | 021 GOJUSHIHO SHO       | 7.4   | 7.4   | 7.0   | 6.8 | (7.8) | (7.6) | (6.4) | (6.4) | 6.4   | 6.6   |    |    |    |    | 14.56 | 6.24 |       | 20.8  | 5    |
| 5 NADIZAR LANA_TISA (SLO) | 068 PAPUREN             | (8.6) | (8.6) | (8.0) | 8.0 | 8.2   | 8.0   | 8.0   | (7.8) | 8.0   | 7.8   |    |    |    |    | 16.94 | 7.14 |       | 24.08 | 2    |
| 6 LAZAREVSKI_MINA (SRB)   | 041 KANKU SHO           | (8.2) | (8.4) | 8.2   | 8.2 | 8.0   | 8.2   | (7.0) | (7.0) | 7.4   | 7.2   |    |    |    |    | 16.52 | 7.08 |       | 23.6  | 3    |

**R1 G3/4 (7) Tatami 5 10:40**

| Competitors                     | Kata              | 1T    | 1A    | 2T    | 2A    | 3T    | 3A    | 4T    | 4A    | 5T    | 5A  | 6T | 6A | 7T | 7A | TEC   | ATH  | Extra | Total | Rank |
|---------------------------------|-------------------|-------|-------|-------|-------|-------|-------|-------|-------|-------|-----|----|----|----|----|-------|------|-------|-------|------|
| 1 HORVAT STELA (CRO)            | 021 GOJUSHIHO SHO | (7.2) | (7.0) | (8.4) | (8.4) | 7.6   | 7.6   | 8.4   | 8.2   | 7.2   | 7.2 |    |    |    |    | 16.24 | 6.9  |       | 23.14 | 4    |
| 2 SARKINOVIC UNA (BIH)          | 021 GOJUSHIHO SHO | (7.0) | (7.2) | (7.8) | (7.8) | 7.4   | 7.2   | 7.6   | 7.2   | 7.6   | 7.2 |    |    |    |    | 15.82 | 6.48 |       | 22.3  | 6    |
| 3 COSTANZO ISABELLA_JOANA (ROU) | 001 ANAN          | (6.8) | (7.0) | (8.6) | (8.6) | 8.0   | 8.0   | 8.0   | 8.0   | 7.4   | 7.4 |    |    |    |    | 16.38 | 7.02 |       | 23.4  | 3    |
| 4 RADOVANOVIC DANICA (MNE)      | 021 GOJUSHIHO SHO | 6.6   | 6.8   | (7.2) | (7.2) | 6.6   | 6.6   | (6.4) | (6.0) | 6.6   | 6.8 |    |    |    |    | 13.86 | 6.06 |       | 19.92 | 7    |
| 5 JOVANOVIC KRSTINA (SRB)       | 021 GOJUSHIHO SHO | (7.4) | (7.8) | (8.2) | 7.8   | 7.8   | (7.6) | 8.2   | 7.8   | 7.8   | 7.8 |    |    |    |    | 16.66 | 7.02 |       | 23.68 | 2    |
| 6 SENGUL HULYANUR (TUR)         | 002 ANAN DAI      | (7.8) | (7.8) | (9.2) | (9.2) | 8.4   | 8.2   | 9.0   | 8.8   | 8.2   | 8.0 |    |    |    |    | 17.92 | 7.5  |       | 25.42 | 1    |
| 7 FAJFER LANA (SLO)             | 015 GANKAKU       | 7.6   | (7.8) | 7.6   | 7.4   | (8.0) | 7.8   | 7.8   | (7.2) | (7.2) | 7.6 |    |    |    |    | 16.1  | 6.84 |       | 22.94 | 5    |

**R1 G4/4 (6) Tatami 5 11:15**

| Competitors             | Kata              | 1T    | 1A    | 2T    | 2A    | 3T    | 3A    | 4T    | 4A    | 5T    | 5A    | 6T | 6A | 7T | 7A | TEC   | ATH  | Extra | Total | Rank |
|-------------------------|-------------------|-------|-------|-------|-------|-------|-------|-------|-------|-------|-------|----|----|----|----|-------|------|-------|-------|------|
| 1 PALIAGA FLAVIA (CRO)  | 021 GOJUSHIHO SHO | 7.8   | (7.8) | 8.2   | 8.2   | (8.4) | (8.4) | 7.8   | 8.0   | (7.6) | 7.8   |    |    |    |    | 16.66 | 7.2  |       | 23.86 | 3    |
| 2 TANOVIC EMINA (BIH)   | 021 GOJUSHIHO SHO | (7.0) | (7.2) | 7.6   | 7.4   | (8.2) | 8.2   | 7.8   | 8.0   | 8.2   | (8.4) |    |    |    |    | 16.52 | 7.08 |       | 23.6  | 4    |
| 3 KOYUNCU PERI (TUR)    | 041 KANKU SHO     | (7.4) | (7.4) | 8.4   | (8.6) | (8.6) | 8.6   | 8.4   | 8.6   | 8.6   | 8.6   |    |    |    |    | 17.78 | 7.74 |       | 25.52 | 1    |
| 4 KOBAL_PAHOR LEA (SLO) | 020 GOJUSHIHO DAI | (8.0) | (7.8) | 8.6   | 8.6   | 8.0   | 7.8   | 8.2   | 8.4   | (9.0) | (9.2) |    |    |    |    | 17.36 | 7.44 |       | 24.8  | 2    |
| 5 LOKI ALMA (KOS)       | 001 ANAN          | (6.6) | (6.6) | 7.4   | 7.4   | 7.6   | 7.8   | (7.8) | (8.0) | 7.0   | 7.0   |    |    |    |    | 15.4  | 6.66 |       | 22.06 | 6    |
| 6 NIKOLIC MILICA (SRB)  | 021 GOJUSHIHO SHO | 7.4   | (7.0) | (8.0) | 8.0   | 7.8   | (8.2) | 7.8   | 7.6   | (7.2) | 7.4   |    |    |    |    | 16.1  | 6.9  |       | 23.0  | 5    |

**R2-G1 Tatami 5 11:45**

| Competitors               | Kata              | 1T    | 1A    | 2T    | 2A    | 3T    | 3A    | 4T    | 4A    | 5T    | 5A    | 6T | 6A | 7T | 7A | TEC   | ATH  | Extra | Total | Rank |
|---------------------------|-------------------|-------|-------|-------|-------|-------|-------|-------|-------|-------|-------|----|----|----|----|-------|------|-------|-------|------|
| 1 ARSOVSKA MARTINA (MKD)  | 015 GANKAKU       | 8.0   | (8.2) | 8.2   | 8.0   | (8.6) | 7.8   | (7.6) | 7.6   | (7.2) |       |    |    |    |    | 16.66 | 7.02 |       | 23.68 | 6    |
| 2 KUTIJA ALJA (SLO)       | 041 KANKU SHO     | 7.6   | 7.8   | 7.6   | 7.6   | 8.2   | (8.2) | (7.2) | (7.4) | (8.4) | 8.2   |    |    |    |    | 16.38 | 7.08 |       | 23.46 | 7    |
| 3 BRAJA KLARA (CRO)       | 002 ANAN DAI      | (7.6) | (7.6) | 8.0   | 7.8   | 8.4   | 8.4   | 8.2   | 8.0   | (8.8) | (8.6) |    |    |    |    | 17.22 | 7.26 |       | 24.48 | 3    |
| 4 MARKOVIC MILA (MNE)     | 021 GOJUSHIHO SHO | 7.0   | (7.2) | 7.4   | 7.4   | (7.8) | (7.8) | 7.4   | 7.6   | (6.8) | 7.6   |    |    |    |    | 15.26 | 6.78 |       | 22.04 | 8    |
| 5 ASLI PEHLIVAN (TUR)     | 021 GOJUSHIHO SHO | 7.8   | 7.8   | (7.2) | (7.6) | (8.8) | (8.8) | 8.0   | 7.8   | 8.6   | 8.2   |    |    |    |    | 17.08 | 7.14 |       | 24.22 | 4    |
| 6 TUREMEN DAMLA_SU (TUR)  | 020 GOJUSHIHO DAI | (8.2) | 8.4   | 8.6   | 8.6   | (9.4) | (9.4) | 8.4   | (8.2) | 9.2   | 9.0   |    |    |    |    | 18.34 | 7.8  |       | 26.14 | 1    |
| 7 LAZAREVSKI_MINA (SRB)   | 021 GOJUSHIHO SHO | (7.2) | (7.4) | 7.8   | 8.0   | (9.0) | (9.0) | 8.0   | 8.0   | 8.2   | 8.4   |    |    |    |    | 16.8  | 7.32 |       | 24.12 | 5    |
| 8 NADIZAR LANA_TISA (SLO) | 002 ANAN DAI      | (7.4) | (7.2) | 8.4   | 8.0   | 8.8   | 8.2   | 8.2   | 8.4   | (9.0) | (8.8) |    |    |    |    | 17.78 | 7.38 |       | 25.16 | 2    |

**R2-G2 Tatami 5 12:25**

| Competitors                     | Kata              | 1T    | 1A    | 2T  | 2A    | 3T    | 3A    | 4T  | 4A  | 5T    | 5A    | 6T | 6A | 7T | 7A | TEC   | ATH  | Extra | Total | Rank |
|---------------------------------|-------------------|-------|-------|-----|-------|-------|-------|-----|-----|-------|-------|----|----|----|----|-------|------|-------|-------|------|
| 1 TANOVIC EMINA (BIH)           | 020 GOJUSHIHO DAI | (8.4) | (8.4) | 7.8 | 7.8   | (7.4) | (7.2) | 7.4 | 7.4 | 8.2   | 8.0   |    |    |    |    | 16.38 | 6.96 |       | 23.34 | 8    |
| 2 SENGUL HULYANUR (TUR)         | 068 PAPUREN       | (9.4) | (9.4) | 8.6 | 8.6   | (8.2) | (8.0) | 8.4 | 8.4 | 8.6   | 8.6   |    |    |    |    | 17.92 | 7.68 |       | 25.6  | 1    |
| 3 COSTANZO ISABELLA_JOANA (ROU) | 068 PAPUREN       | (8.6) | (8.6) | 8.2 | (8.0) | (7.8) | 8.0   | 8.4 | 8.6 | 8.4   | 8.2   |    |    |    |    | 17.5  | 7.44 |       | 24.94 | 3    |
| 4 HORVAT STELA (CRO)            | 099 UNSU          | 8.2   | 8.2   | 8.0 | 8.0   | (7.0) | (7.2) | 7.8 | 7.8 | (8.8) | (8.8) |    |    |    |    | 16.8  | 7.2  |       | 24.0  | 6    |

**21st Balkan Karate Championships for Cadets,  
Juniors and U21 - RIJEKA 2021 - 2021-11-26**

**Junior Kata Female**

|   |                         |                   |       |       |       |       |       |       |     |       |       |       |  |  |  |  |       |      |  |       |   |
|---|-------------------------|-------------------|-------|-------|-------|-------|-------|-------|-----|-------|-------|-------|--|--|--|--|-------|------|--|-------|---|
| 5 | JOVANOVIC KRSTINA (SRB) | 020 GOJUSHIHO DAI | 8.0   | 8.0   | (7.6) | (7.6) | 7.6   | 8.0   | 7.6 | 7.8   | (8.6) | (8.6) |  |  |  |  | 16.24 | 7.14 |  | 23.38 | 7 |
| 6 | KOBAL_PAHOR LEA (SLO)   | 099 UNSU          | 8.8   | 8.2   | (7.8) | 8.2   | 8.0   | (8.0) | 8.2 | 8.0   | (9.0) | (8.6) |  |  |  |  | 17.5  | 7.32 |  | 24.82 | 4 |
| 7 | PALIAGA FLAVIA (CRO)    | 099 UNSU          | (8.8) | (8.4) | 8.4   | 8.0   | (7.2) | 7.8   | 8.0 | (7.6) | 8.4   | 8.0   |  |  |  |  | 17.36 | 7.14 |  | 24.5  | 5 |
| 8 | KOYUNCU PERI (TUR)      | 021 GOJUSHIHO SHO | (9.2) | (9.2) | 8.6   | 8.2   | (8.4) | 8.2   | 8.6 | 8.4   | 8.4   | (7.8) |  |  |  |  | 17.92 | 7.44 |  | 25.36 | 2 |

**R3-G1 Tatami 5 13:05**

| Competitors               | Kata          | 1T    | 1A    | 2T    | 2A    | 3T  | 3A  | 4T    | 4A    | 5T    | 5A    | 6T | 6A | 7T | 7A | TEC   | ATH  | Extra | Total Rank |   |
|---------------------------|---------------|-------|-------|-------|-------|-----|-----|-------|-------|-------|-------|----|----|----|----|-------|------|-------|------------|---|
| 1 TUREMEN DAMLA_SU (TUR)  | 041 KANKU SHO | (8.8) | 8.8   | 8.4   | 8.6   | 8.6 | 8.6 | 8.8   | (9.0) | (8.2) | (8.4) |    |    |    |    | 18.06 | 7.8  |       | 25.86      | 1 |
| 2 NADIZAR LANA_TISA (SLO) | 001 ANAN      | (8.2) | (8.2) | 8.2   | (8.4) | 8.2 | 8.2 | (8.0) | 8.2   | 8.0   | 8.2   |    |    |    |    | 17.08 | 7.38 |       | 24.46      | 3 |
| 3 BRAJA KLARA (CRO)       | 061 NIPAPO    | 8.4   | 8.2   | (7.8) | (8.0) | 8.4 | 8.4 | (8.6) | (9.0) | 8.4   | 8.6   |    |    |    |    | 17.64 | 7.56 |       | 25.2       | 2 |
| 4 ASLI PEHLIVAN (TUR)     | 099 UNSU      | (8.0) | (8.0) | (7.6) | 7.8   | 7.8 | 8.0 | 7.6   | (7.2) | 7.8   | 8.0   |    |    |    |    | 16.24 | 7.14 |       | 23.38      | 4 |

**R3-G2 Tatami 5 13:25**

| Competitors                     | Kata                    | 1T    | 1A    | 2T  | 2A  | 3T    | 3A    | 4T  | 4A    | 5T  | 5A    | 6T | 6A | 7T | 7A | TEC   | ATH  | Extra | Total Rank |   |
|---------------------------------|-------------------------|-------|-------|-----|-----|-------|-------|-----|-------|-----|-------|----|----|----|----|-------|------|-------|------------|---|
| 1 KOBAL_PAHOR LEA (SLO)         | 015 GANKAKU             | (7.8) | 8.0   | 8.2 | 8.2 | (8.6) | (8.4) | 8.0 | (7.8) | 7.8 | 7.8   |    |    |    |    | 16.8  | 7.2  |       | 24.0       | 3 |
| 2 COSTANZO ISABELLA_JOANA (ROU) | 008 CHATANYARA KUSHANKU | (7.6) | 7.8   | 8.0 | 7.8 | (8.2) | (8.2) | 7.6 | 7.8   | 7.6 | (7.6) |    |    |    |    | 16.24 | 7.02 |       | 23.26      | 4 |
| 3 SENGUL HULYANUR (TUR)         | 008 CHATANYARA KUSHANKU | (7.4) | (7.8) | 8.6 | 8.4 | (8.8) | 8.6   | 8.6 | (8.8) | 8.4 | 8.4   |    |    |    |    | 17.92 | 7.62 |       | 25.54      | 1 |
| 4 KOYUNCU PERI (TUR)            | 020 GOJUSHIHO DAI       | (8.0) | (8.2) | 8.4 | 8.4 | (8.8) | (8.8) | 8.2 | 8.4   | 8.0 | 8.2   |    |    |    |    | 17.22 | 7.5  |       | 24.72      | 2 |

**R4 Bronze Medal Match 1 Tatami 5 13:45**

| Competitors             | Kata              | 1T    | 1A  | 2T    | 2A    | 3T  | 3A  | 4T  | 4A    | 5T    | 5A    | 6T | 6A | 7T | 7A | TEC   | ATH  | Extra | Total Rank |   |
|-------------------------|-------------------|-------|-----|-------|-------|-----|-----|-----|-------|-------|-------|----|----|----|----|-------|------|-------|------------|---|
| 1 BRAJA KLARA (CRO)     | 067 PAIKU         | 8.2   | 8.2 | (7.6) | (7.8) | 8.4 | 8.2 | 8.2 | 8.4   | (8.6) | (8.8) |    |    |    |    | 17.36 | 7.44 |       | 24.8       | 1 |
| 2 KOBAL_PAHOR LEA (SLO) | 021 GOJUSHIHO SHO | (8.4) | 8.4 | (7.8) | (8.0) | 8.0 | 8.0 | 8.4 | (8.6) | 8.2   | 8.4   |    |    |    |    | 17.22 | 7.44 |       | 24.66      | 2 |







**R4 Bronze Medal Match 2 Tatami 5 13:55**

| Competitors               | Kata           | 1T    | 1A    | 2T  | 2A  | 3T    | 3A    | 4T  | 4A  | 5T  | 5A  | 6T | 6A | 7T | 7A | TEC  | ATH  | Extra | Total Rank |   |
|---------------------------|----------------|-------|-------|-----|-----|-------|-------|-----|-----|-----|-----|----|----|----|----|------|------|-------|------------|---|
| 1 NADIZAR LANA_TISA (SLO) | 092 SUPARINPEI | (7.8) | (8.0) | 8.2 | 8.2 | (8.6) | (8.8) | 8.2 | 8.0 | 8.6 | 8.4 |    |    |    |    | 17.5 | 7.38 |       | 24.88      | 2 |
| 2 KOYUNCU PERI (TUR)      | 015 GANKAKU    | (7.6) | (7.8) | 8.0 | 8.0 | (9.0) | (8.8) | 8.0 | 8.4 | 9.0 | 8.8 |    |    |    |    | 17.5 | 7.56 |       | 25.06      | 1 |

**R4 Gold Medal Match Tatami 5 14:05**

| Competitors              | Kata     | 1T    | 1A    | 2T  | 2A    | 3T    | 3A    | 4T  | 4A  | 5T  | 5A  | 6T | 6A | 7T | 7A | TEC   | ATH  | Extra | Total Rank |   |
|--------------------------|----------|-------|-------|-----|-------|-------|-------|-----|-----|-----|-----|----|----|----|----|-------|------|-------|------------|---|
| 1 TUREMEN DAMLA_SU (TUR) | 099 UNSU | (9.4) | (9.4) | 8.6 | 8.6   | (8.2) | (8.4) | 8.8 | 9.0 | 8.6 | 8.6 |    |    |    |    | 18.2  | 7.86 |       | 26.06      | 1 |
| 2 SENGUL HULYANUR (TUR)  | 001 ANAN | (9.0) | (9.0) | 8.4 | (8.2) | (8.0) | 8.2   | 8.0 | 8.4 | 8.4 | 8.8 |    |    |    |    | 17.36 | 7.62 |       | 24.98      | 2 |

**Results**

|   |                         |          |   |          |
|---|-------------------------|----------|---|----------|
| 1 | TUREMEN DAMLA SU        | TURKEY   |  | TURKEY   |
| 2 | SENGUL HULYANUR         | TURKEY   |  | TURKEY   |
| 3 | BRAJA KLARA             | CROATIA  |  | CROATIA  |
| 3 | KOYUNCU PERI            | TURKEY   |  | TURKEY   |
| 5 | KOBAL PAHOR LEA         | SLOVENIA |  | SLOVENIA |
| 5 | NADIZAR LANA TISA       | SLOVENIA |  | SLOVENIA |
| 7 | ASLI PEHLIVAN           | TURKEY   |  | TURKEY   |
| 7 | COSTANZO ISABELLA JOANA | ROMANIA  |  | ROMANIA  |

**21st Balkan Karate Championships for Cadets,  
Juniors and U21 - RIJEKA 2021 - 2021-11-26**

**Junior Kata Male**

**R1 G1/2 (12) Tatami 5 09:00**

| Competitors                     | Kata              | 1T    | 1A    | 2T    | 2A    | 3T    | 3A    | 4T    | 4A    | 5T    | 5A    | 6T | 6A | 7T | 7A | TEC   | ATH  | Extra | Total | Rank |
|---------------------------------|-------------------|-------|-------|-------|-------|-------|-------|-------|-------|-------|-------|----|----|----|----|-------|------|-------|-------|------|
| 1 HALILOVIC MUAMER (BIH)        | 099 UNSU          | 7.4   | 7.4   | (7.6) | 7.4   | 7.6   | (7.6) | 7.4   | 7.6   | (7.0) | (6.8) |    |    |    |    | 15.68 | 6.72 |       | 22.4  | 8    |
| 2 STOJANCEVSKI ALEKSANDAR (MKD) | 041 KANKU SHO     | (7.8) | (8.0) | 6.6   | 7.0   | 7.8   | 7.6   | 6.8   | 7.2   | (5.8) | (6.0) |    |    |    |    | 14.84 | 6.54 |       | 21.38 | 11   |
| 3 GRIGORIU STEFAN_ ANTON (ROU)  | 099 UNSU          | (7.2) | (7.4) | 7.2   | 6.8   | 7.2   | 7.2   | (6.2) | (6.4) | 6.8   | 6.6   |    |    |    |    | 14.84 | 6.18 |       | 21.02 | 12   |
| 4 KILIC YUSUF (TUR)             | 067 PAIKU         | 8.4   | 8.2   | (8.8) | (8.6) | 8.2   | 8.2   | 8.2   | 8.6   | (7.6) | (7.6) |    |    |    |    | 17.36 | 7.5  |       | 24.86 | 2    |
| 5 PAVLOVIC STEFAN (SRB)         | 021 GOJUSHIHO SHO | 7.8   | 7.6   | (8.2) | (8.2) | 7.4   | 7.6   | 6.4   | 6.6   | (6.0) | (6.2) |    |    |    |    | 15.12 | 6.54 |       | 21.66 | 10   |
| 6 MATUSKI GEORGI (BUL)          | 001 ANAN          | 7.6   | 8.0   | 7.4   | 7.8   | (8.0) | (8.4) | (7.0) | (7.2) | 7.2   | 7.2   |    |    |    |    | 15.54 | 6.9  |       | 22.44 | 7    |
| 7 SOPER ERIK (CRO)              | 041 KANKU SHO     | 7.6   | 7.8   | (7.8) | (8.0) | 7.8   | 8.0   | 7.2   | 7.6   | (5.8) | (5.8) |    |    |    |    | 15.82 | 7.02 |       | 22.84 | 6    |
| 8 MOCNIK TIMI (SLO)             | 002 ANAN DAI      | 8.2   | 8.0   | (8.6) | (8.4) | 8.0   | 7.6   | 7.8   | 7.6   | (7.0) | (7.0) |    |    |    |    | 16.8  | 6.96 |       | 23.76 | 3    |
| 9 MILIC_NIKOLA (MNE)            | 021 GOJUSHIHO SHO | (8.6) | (8.8) | 8.4   | 8.0   | 8.0   | 8.2   | 6.6   | 7.0   | (6.4) | (6.2) |    |    |    |    | 16.1  | 6.96 |       | 23.06 | 5    |
| 10 TSIKMAKIS FOTIOS (GRE)       | 064 OHAN DAI      | 7.8   | 7.6   | (8.2) | (8.6) | 7.8   | 8.0   | 8.0   | 8.2   | (7.2) | (7.2) |    |    |    |    | 16.52 | 7.14 |       | 23.66 | 4    |
| 11 PESHKOV ANDREJ (MKD)         | 041 KANKU SHO     | 7.2   | (7.8) | (7.8) | 7.6   | 7.4   | 7.8   | 7.4   | 7.0   | (7.0) | (6.8) |    |    |    |    | 15.4  | 6.72 |       | 22.12 | 9    |
| 12 DJOKIC ANDRIJA (SRB)         | 021 GOJUSHIHO SHO | (8.8) | (9.0) | 8.6   | 8.0   | 8.2   | 8.6   | 8.6   | 8.8   | (6.0) | (6.4) |    |    |    |    | 17.78 | 7.62 |       | 25.4  | 1    |

**R1 G2/2 (11) Tatami 5 10:00**

| Competitors                  | Kata                      | 1T    | 1A    | 2T    | 2A    | 3T    | 3A    | 4T    | 4A    | 5T    | 5A    | 6T | 6A | 7T | 7A | TEC   | ATH  | Extra | Total | Rank |
|------------------------------|---------------------------|-------|-------|-------|-------|-------|-------|-------|-------|-------|-------|----|----|----|----|-------|------|-------|-------|------|
| 1 HALILOSANI NORIK (KOS)     | 021 GOJUSHIHO SHO         | (5.4) | (5.2) | 5.8   | (6.0) | (6.2) | 6.0   | 5.6   | 6.0   | 5.8   | 6.0   |    |    |    |    | 12.04 | 5.4  |       | 17.44 | 11   |
| 2 KOUKOUSSELIS IOANNIS (GRE) | 043 KISHIMOTO NO KUSHANKU | 8.4   | 8.6   | 8.2   | 8.4   | (7.8) | (7.6) | 7.8   | 7.6   | (8.6) | (8.8) |    |    |    |    | 17.08 | 7.38 |       | 24.46 | 2    |
| 3 ANDRIC HRISTIJAN (MKD)     | 021 GOJUSHIHO SHO         | (7.0) | 7.0   | 7.4   | 7.6   | 7.2   | (6.8) | 7.0   | 7.2   | (7.6) | (7.8) |    |    |    |    | 15.12 | 6.54 |       | 21.66 | 10   |
| 4 PURIC MILOS (SRB)          | 021 GOJUSHIHO SHO         | 7.8   | 8.0   | (8.0) | (8.2) | (7.6) | (7.4) | 8.0   | 8.2   | 8.0   | 8.2   |    |    |    |    | 16.66 | 7.32 |       | 23.98 | 3    |
| 5 AKBABA ALI_EFE (TUR)       | 067 PAIKU                 | 8.0   | 8.2   | 8.2   | 8.4   | (7.4) | 7.6   | 7.4   | (7.4) | (8.4) | (8.6) |    |    |    |    | 16.52 | 7.26 |       | 23.78 | 5    |
| 6 VULPOIU EDUARD (ROU)       | 068 PAPUREN               | (7.6) | (7.8) | 8.0   | 8.2   | 8.0   | 7.8   | 7.8   | 8.2   | (9.0) | (9.2) |    |    |    |    | 16.66 | 7.26 |       | 23.92 | 4    |
| 7 SPASOVSKI DAVID (MKD)      | 021 GOJUSHIHO SHO         | 7.6   | 7.8   | 8.0   | 8.0   | 7.8   | (7.6) | (7.4) | 8.0   | (8.4) | (8.2) |    |    |    |    | 16.38 | 7.14 |       | 23.52 | 6    |
| 8 BRAVARIC_CILO DAMJAN (CRO) | 099 UNSU                  | 7.4   | 7.8   | (7.8) | (8.0) | (6.8) | (6.8) | 6.8   | 7.2   | 7.8   | 7.4   |    |    |    |    | 15.4  | 6.72 |       | 22.12 | 9    |
| 9 ASLAN GORKEM (TUR)         | 067 PAIKU                 | 8.0   | 8.4   | 8.6   | 8.8   | 8.2   | (8.0) | (7.6) | 8.0   | (9.4) | (9.2) |    |    |    |    | 17.36 | 7.56 |       | 24.92 | 1    |
| 10 SLUGA JURE (SLO)          | 099 UNSU                  | (6.6) | (7.2) | 8.0   | 7.8   | 7.8   | 7.6   | 7.2   | 7.8   | (8.4) | (9.2) |    |    |    |    | 16.1  | 6.96 |       | 23.06 | 8    |
| 11 SEKULIC LAZAR (MNE)       | 099 UNSU                  | (6.8) | (6.8) | 8.2   | 8.4   | 7.6   | 7.6   | 7.2   | 7.8   | (9.2) | (8.8) |    |    |    |    | 16.1  | 7.14 |       | 23.24 | 7    |

**R2-G1 Tatami 5 11:00**

| Competitors              | Kata           | 1T    | 1A    | 2T    | 2A    | 3T    | 3A  | 4T  | 4A  | 5T    | 5A  | 6T | 6A | 7T | 7A | TEC   | ATH  | Extra | Total | Rank |
|--------------------------|----------------|-------|-------|-------|-------|-------|-----|-----|-----|-------|-----|----|----|----|----|-------|------|-------|-------|------|
| 1 KILIC YUSUF (TUR)      | 092 SUPARINPEI | (8.4) | (8.6) | 9.0   | (9.2) | (9.2) | 9.0 | 8.4 | 8.8 | 8.8   | 9.0 |    |    |    |    | 18.34 | 8.04 |       | 26.38 | 1    |
| 2 DJOKIC ANDRIJA (SRB)   | 041 KANKU SHO  | (7.6) | (7.6) | (9.2) | (9.4) | 8.8   | 8.4 | 7.8 | 8.4 | 8.4   | 8.6 |    |    |    |    | 17.5  | 7.62 |       | 25.12 | 2    |
| 3 MOCNIK TIMI (SLO)      | 064 OHAN DAI   | 8.2   | (8.0) | (8.8) | (8.6) | 8.2   | 8.0 | 8.2 | 8.0 | (8.0) | 8.2 |    |    |    |    | 17.22 | 7.26 |       | 24.48 | 3    |
| 4 TSIKMAKIS FOTIOS (GRE) | 001 ANAN       | 7.8   | (7.6) | (8.4) | (8.2) | (7.4) | 7.6 | 8.0 | 7.8 | 7.4   | 7.6 |    |    |    |    | 16.24 | 6.9  |       | 23.14 | 4    |

**R2-G2 Tatami 5 11:20**

| Competitors                  | Kata              | 1T  | 1A  | 2T    | 2A    | 3T    | 3A    | 4T    | 4A  | 5T    | 5A  | 6T | 6A | 7T | 7A | TEC   | ATH  | Extra | Total | Rank |
|------------------------------|-------------------|-----|-----|-------|-------|-------|-------|-------|-----|-------|-----|----|----|----|----|-------|------|-------|-------|------|
| 1 ASLAN GORKEM (TUR)         | 002 ANAN DAI      | 8.6 | 8.8 | (9.2) | (9.4) | (8.0) | (8.2) | 8.6   | 8.6 | 9.2   | 9.2 |    |    |    |    | 18.48 | 7.98 |       | 26.46 | 1    |
| 2 VULPOIU EDUARD (ROU)       | 001 ANAN          | 7.8 | 8.0 | (8.8) | (8.6) | (7.4) | (7.4) | 8.2   | 8.2 | 8.8   | 8.6 |    |    |    |    | 17.36 | 7.44 |       | 24.8  | 2    |
| 3 KOUKOUSSELIS IOANNIS (GRE) | 078 SANSAN        | 8.4 | 8.6 | (9.0) | (8.8) | (7.6) | (7.8) | 8.0   | 8.0 | 8.2   | 8.4 |    |    |    |    | 17.22 | 7.5  |       | 24.72 | 3    |
| 4 PURIC MILOS (SRB)          | 020 GOJUSHIHO DAI | 8.2 | 8.2 | 8.2   | (8.0) | 8.2   | (8.4) | (8.4) | 8.4 | (7.8) | 8.0 |    |    |    |    | 17.22 | 7.38 |       | 24.6  | 4    |

**R3 Bronze Medal Match 1 Tatami 5 11:40**

| Competitors                  | Kata              | 1T    | 1A    | 2T  | 2A  | 3T    | 3A    | 4T  | 4A    | 5T    | 5A  | 6T | 6A | 7T | 7A | TEC   | ATH  | Extra | Total | Rank |
|------------------------------|-------------------|-------|-------|-----|-----|-------|-------|-----|-------|-------|-----|----|----|----|----|-------|------|-------|-------|------|
| 1 DJOKIC ANDRIJA (SRB)       | 020 GOJUSHIHO DAI | (8.2) | (8.2) | 8.8 | 8.8 | (9.2) | (9.2) | 8.4 | 8.6   | 8.6   | 8.4 |    |    |    |    | 18.06 | 7.74 |       | 25.8  | 2    |
| 2 KOUKOUSSELIS IOANNIS (GRE) | 002 ANAN DAI      | (8.4) | (8.2) | 8.6 | 8.6 | 9.0   | 9.0   | 9.0 | (9.2) | (9.2) | 9.0 |    |    |    |    | 18.62 | 7.98 |       | 26.6  | 1    |



**R3 Bronze Medal Match 2 Tatami 5 11:50**

| Competitors            | Kata                    | 1T    | 1A    | 2T  | 2A    | 3T    | 3A    | 4T  | 4A  | 5T  | 5A    | 6T | 6A | 7T | 7A | TEC  | ATH  | Extra | Total | Rank |
|------------------------|-------------------------|-------|-------|-----|-------|-------|-------|-----|-----|-----|-------|----|----|----|----|------|------|-------|-------|------|
| 1 MOCNIK TIMI (SLO)    | 009 CHIBANA NO KUSHANKU | (8.4) | (8.6) | 8.2 | (8.0) | (8.0) | 8.2   | 8.4 | 8.2 | 8.4 | 8.6   |    |    |    |    | 17.5 | 7.5  |       | 25.0  | 2    |
| 2 VULPOIU EDUARD (ROU) | 002 ANAN DAI            | (9.0) | 9.0   | 8.4 | 8.6   | (8.2) | (8.4) | 8.6 | 8.6 | 9.0 | (9.2) |    |    |    |    | 18.2 | 7.86 |       | 26.06 | 1    |

**R3 Gold Medal Match Tatami 5 12:00**







| Competitors          | Kata           | 1T    | 1A    | 2T    | 2A    | 3T    | 3A  | 4T  | 4A  | 5T    | 5A    | 6T | 6A | 7T | 7A | TEC   | ATH  | Extra | Total | Rank |
|----------------------|----------------|-------|-------|-------|-------|-------|-----|-----|-----|-------|-------|----|----|----|----|-------|------|-------|-------|------|
| 1 KILIC YUSUF (TUR)  | 002 ANAN DAI   | (9.2) | (9.2) | (8.2) | (8.4) | 8.8   | 9.0 | 8.6 | 8.4 | 8.4   | 8.6   |    |    |    |    | 18.06 | 7.8  |       | 25.86 | 2    |
| 2 ASLAN GORKEM (TUR) | 092 SUPARINPEI | 9.0   | (9.4) | 8.6   | 8.6   | (9.2) | 9.4 | 9.0 | 9.2 | (8.2) | (8.4) |    |    |    |    | 18.62 | 8.16 |       | 26.78 | 1    |

**Results**

|   |              |        |  |        |
|---|--------------|--------|--|--------|
| 1 | ASLAN GORKEM | TURKEY |  | TURKEY |
| 2 | KILIC YUSUF  | TURKEY |  | TURKEY |

**21st Balkan Karate Championships for Cadets,  
Juniors and U21 - RIJEKA 2021 - 2021-11-26**

**Junior Kata Male**

|   |                     |          |   |          |
|---|---------------------|----------|---|----------|
| 3 | KOUKOUSELIS IOANNIS | GREECE   |  | GREECE   |
| 3 | VULPOIU EDUARD      | ROMANIA  |  | ROMANIA  |
| 5 | DJOKIC ANDRIJA      | SERBIA   |  | SERBIA   |
| 5 | MOCNIK TIMI         | SLOVENIA |  | SLOVENIA |
| 7 | TSIAKMAKIS FOTIOS   | GREECE   |  | GREECE   |
| 7 | VULPOIU EDUARD      | ROMANIA  |  | ROMANIA  |





# JUNIOR KUMITE FEMALE -48 KG

21st Balkan Karate Championships for Cadets, Juniors and U21 - RIJEKA 2021

Tatami  
2 15:40

Pool  
1

(c)sportdata GmbH & Co KG 2000-2021(2021-11-29 16:49) -WKF Approved- v 9.8.8 build 3 (2021-11-04) License: SDIL Sportdata Internal License 2021 (expire 2021-12-31)

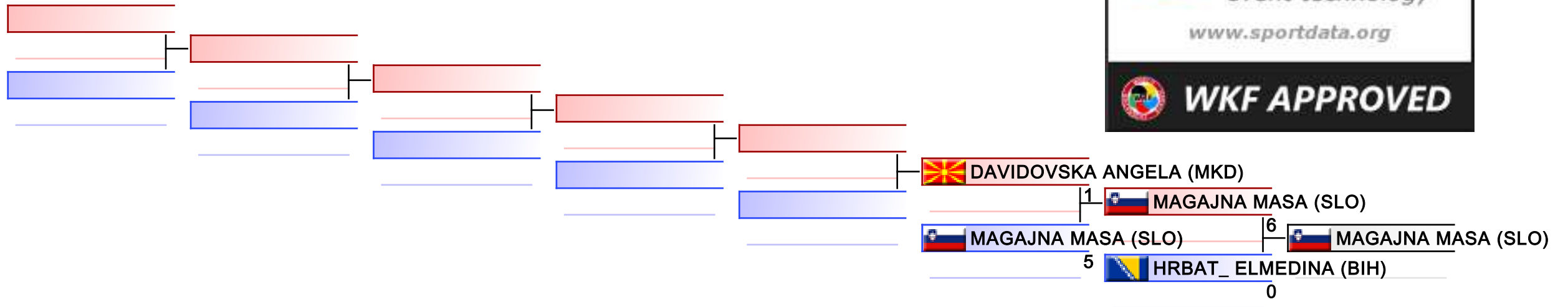

## REPECHAGE: (1)

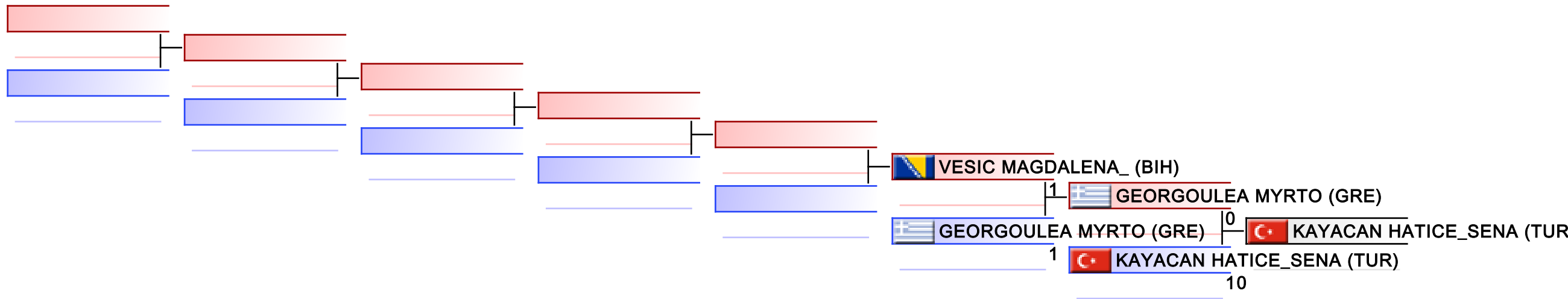

|           |  |  |  |  |  |  |  |
|-----------|--|--|--|--|--|--|--|
| Referees: |  |  |  |  |  |  |  |
|-----------|--|--|--|--|--|--|--|



# JUNIOR KUMITE FEMALE -53 KG

21st Balkan Karate Championships for Cadets, Juniors and U21 - RIJEKA 2021, RIJEKA, CRO

Tatami  
3 09:00

Pool  
1/1

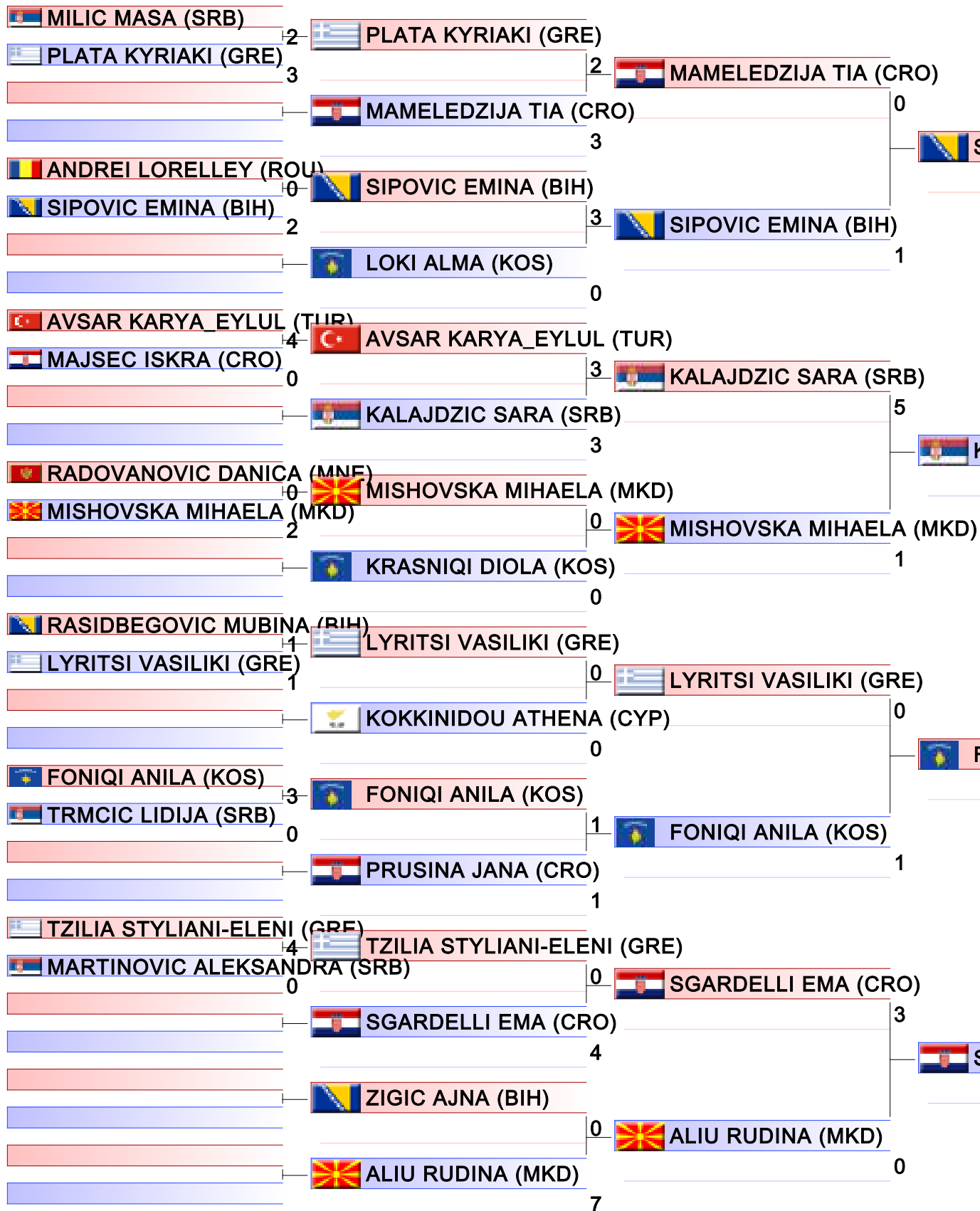

Final

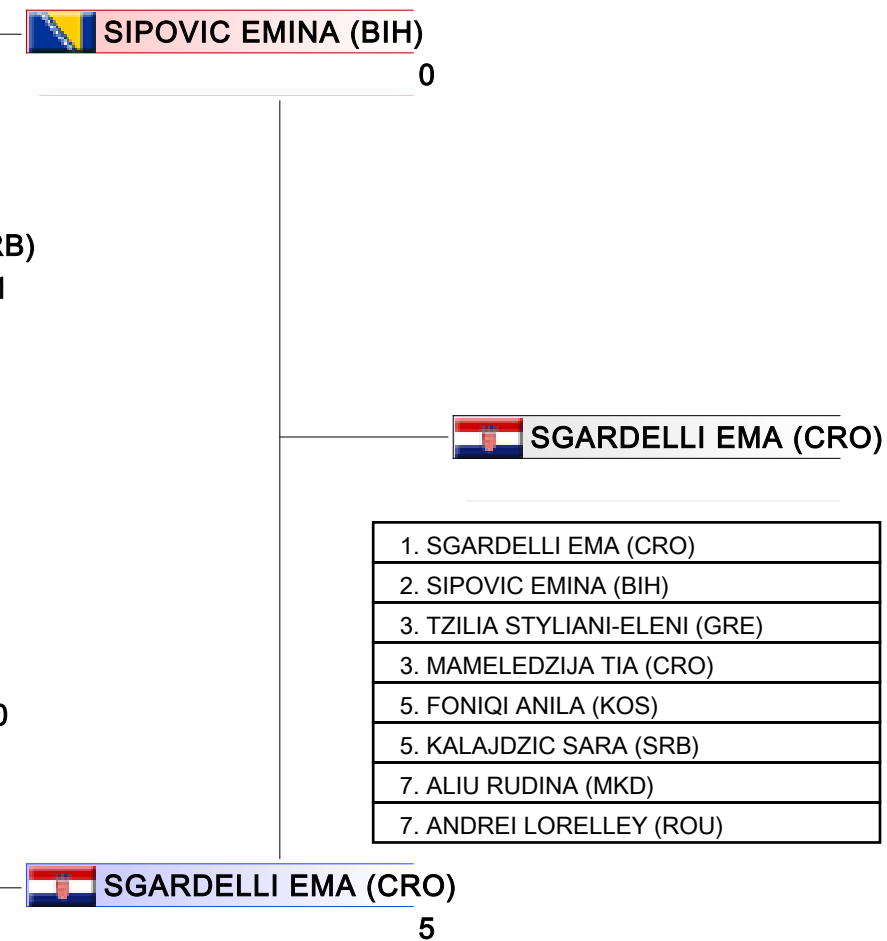

|           |  |  |  |
|-----------|--|--|--|
| Referees: |  |  |  |
|           |  |  |  |

# JUNIOR KUMITE FEMALE -53 KG

21st Balkan Karate Championships for Cadets, Juniors and U21 - RIJEKA 2021

Tatami  
3 10:25

Pool  
1

(c)sportdata GmbH & Co KG 2000-2021(2021-11-29 16:49) -WKF Approved- v 9.8.8 build 3 (2021-11-04) License: SDIL Sportdata Internal License 2021 (expire 2021-12-31)

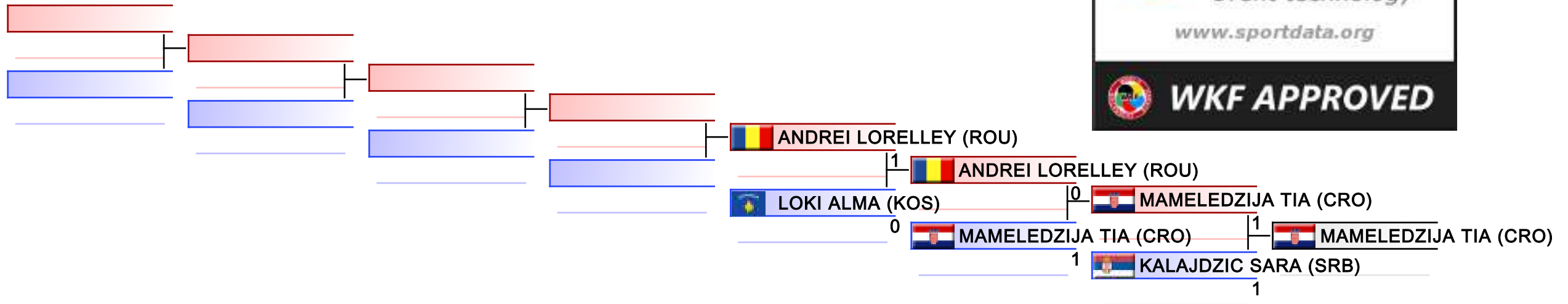

## REPECHAGE: (1)

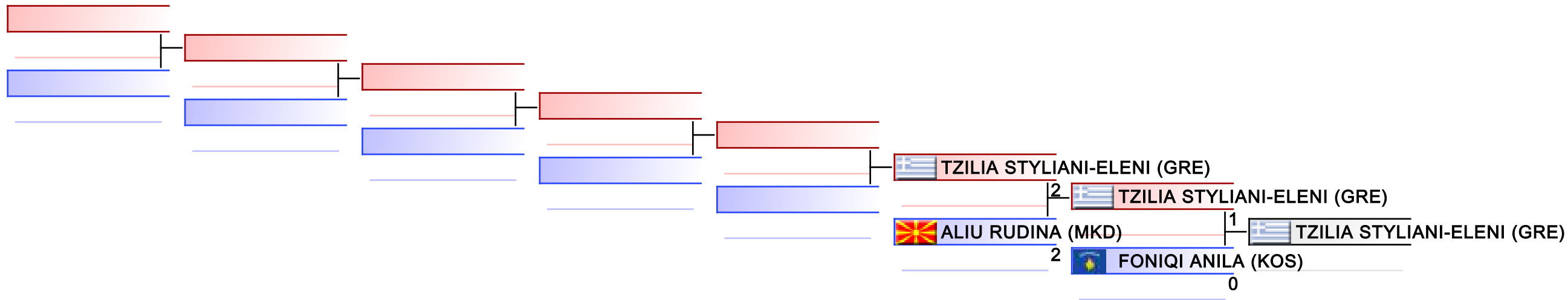

|           |  |  |  |  |  |  |  |
|-----------|--|--|--|--|--|--|--|
| Referees: |  |  |  |  |  |  |  |
|-----------|--|--|--|--|--|--|--|

# JUNIOR KUMITE FEMALE -59 KG

21st Balkan Karate Championships for Cadets, Juniors and U21 - RIJEKA 2021, RIJEKA, CRO

Tatami  
1 13:45

Pool  
1/1

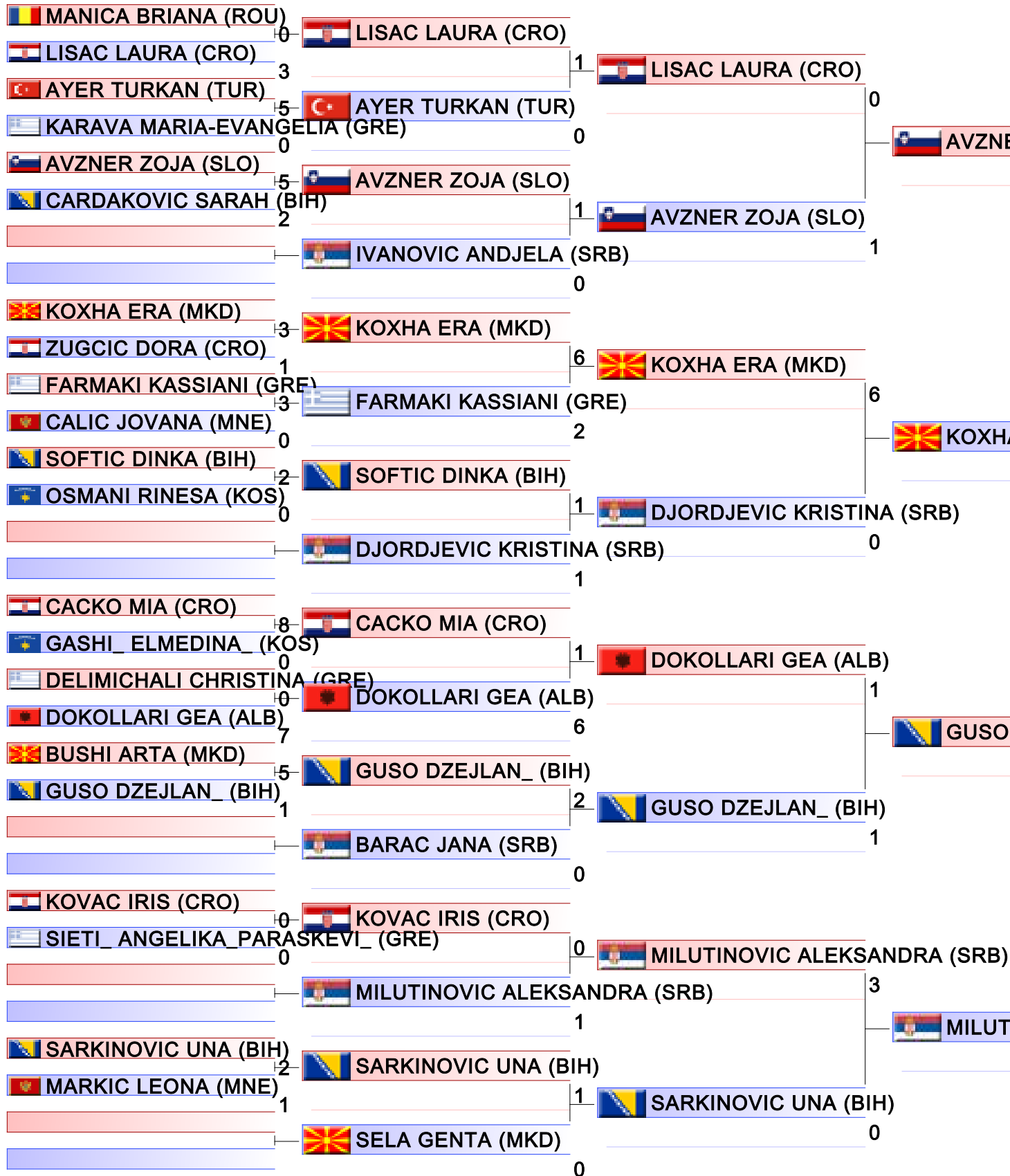

Final

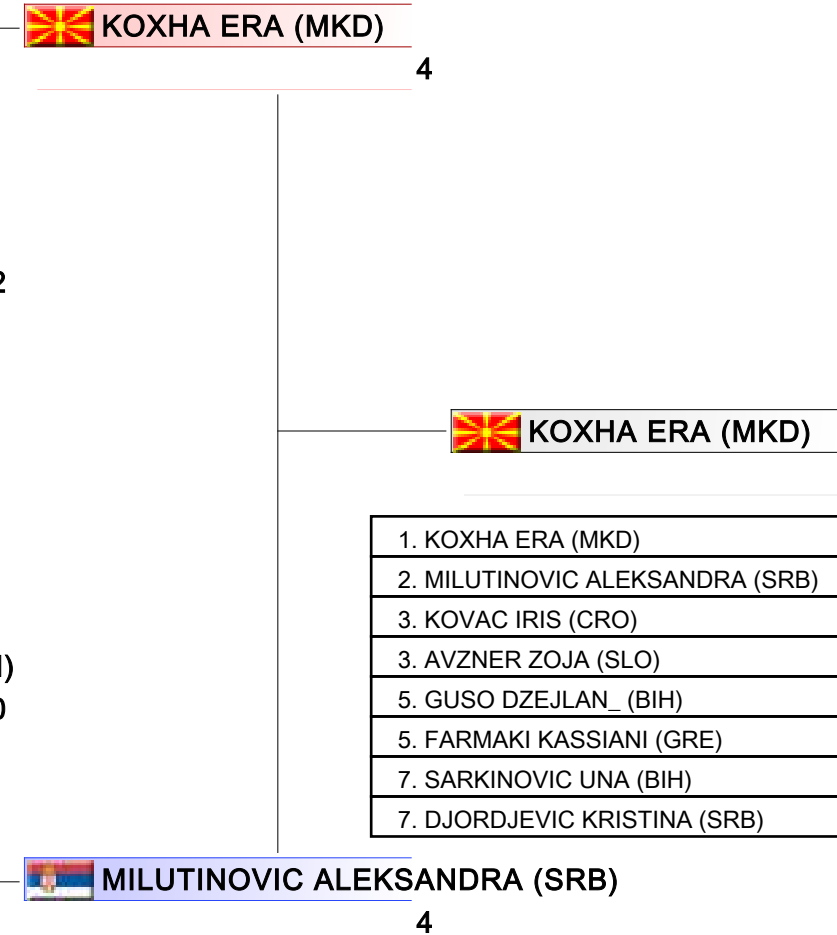

|                                 |
|---------------------------------|
| 1. KOXHA ERA (MKD)              |
| 2. MILUTINOVIC ALEKSANDRA (SRB) |
| 3. KOVAC IRIS (CRO)             |
| 3. AVZNER ZOJA (SLO)            |
| 5. GUSO DZEJLAN_ (BIH)          |
| 5. FARMAKI KASSIANI (GRE)       |
| 7. SARKINOVIC UNA (BIH)         |
| 7. DJORDJEVIC KRISTINA (SRB)    |

|           |  |  |  |
|-----------|--|--|--|
| Referees: |  |  |  |
|           |  |  |  |

# JUNIOR KUMITE FEMALE -59 KG

21st Balkan Karate Championships for Cadets, Juniors and U21 - RIJEKA 2021

Tatami  
1 15:25

Pool  
1

(c)sportdata GmbH & Co KG 2000-2021(2021-11-29 16:49) -WKF Approved- v 9.8.8 build 3 (2021-11-04) License: SDIL Sportdata Internal License 2021 (expire 2021-12-31)

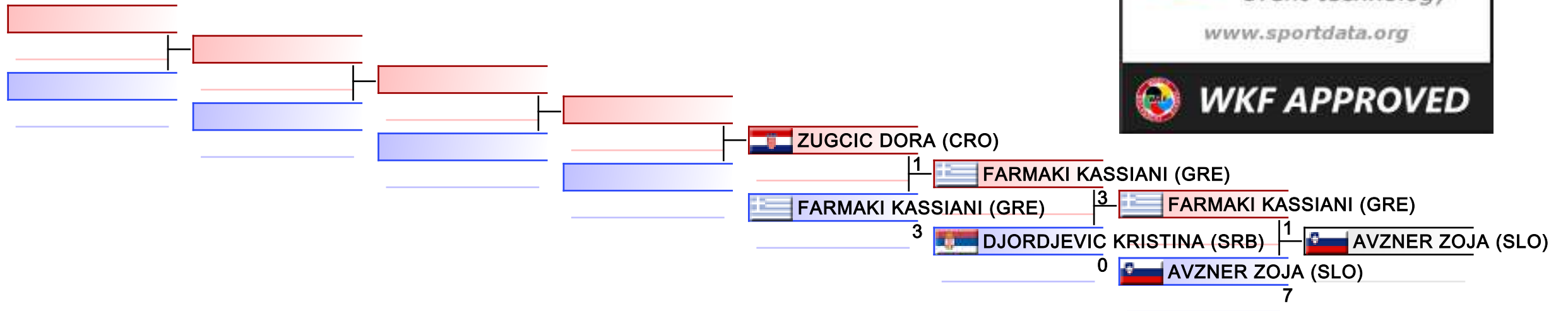

## REPECHAGE: (1)

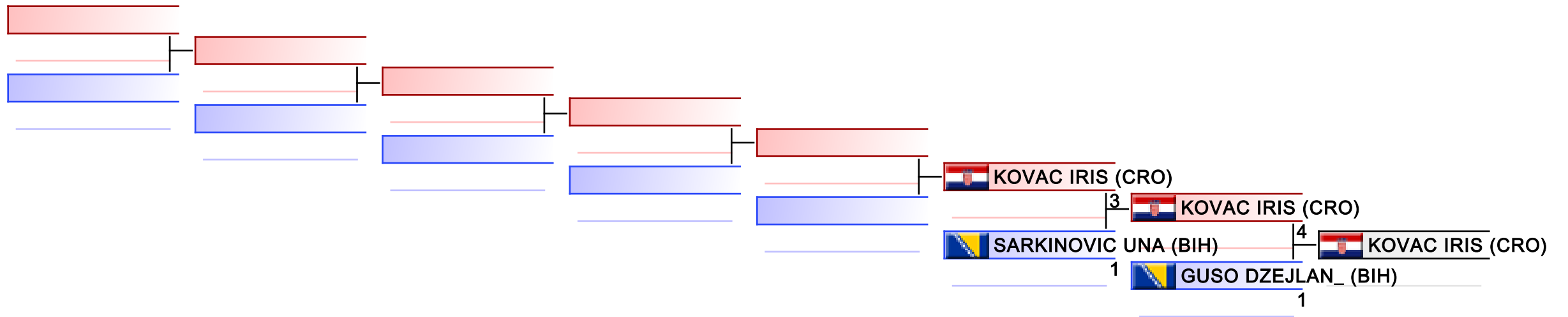

|           |  |  |  |  |  |  |  |
|-----------|--|--|--|--|--|--|--|
| Referees: |  |  |  |  |  |  |  |
|-----------|--|--|--|--|--|--|--|

# JUNIOR KUMITE FEMALE 59+ KG

21st Balkan Karate Championships for Cadets, Juniors and U21 - RIJEKA 2021, RIJEKA, CRO

Tatami  
2 11:40

Pool  
1/1

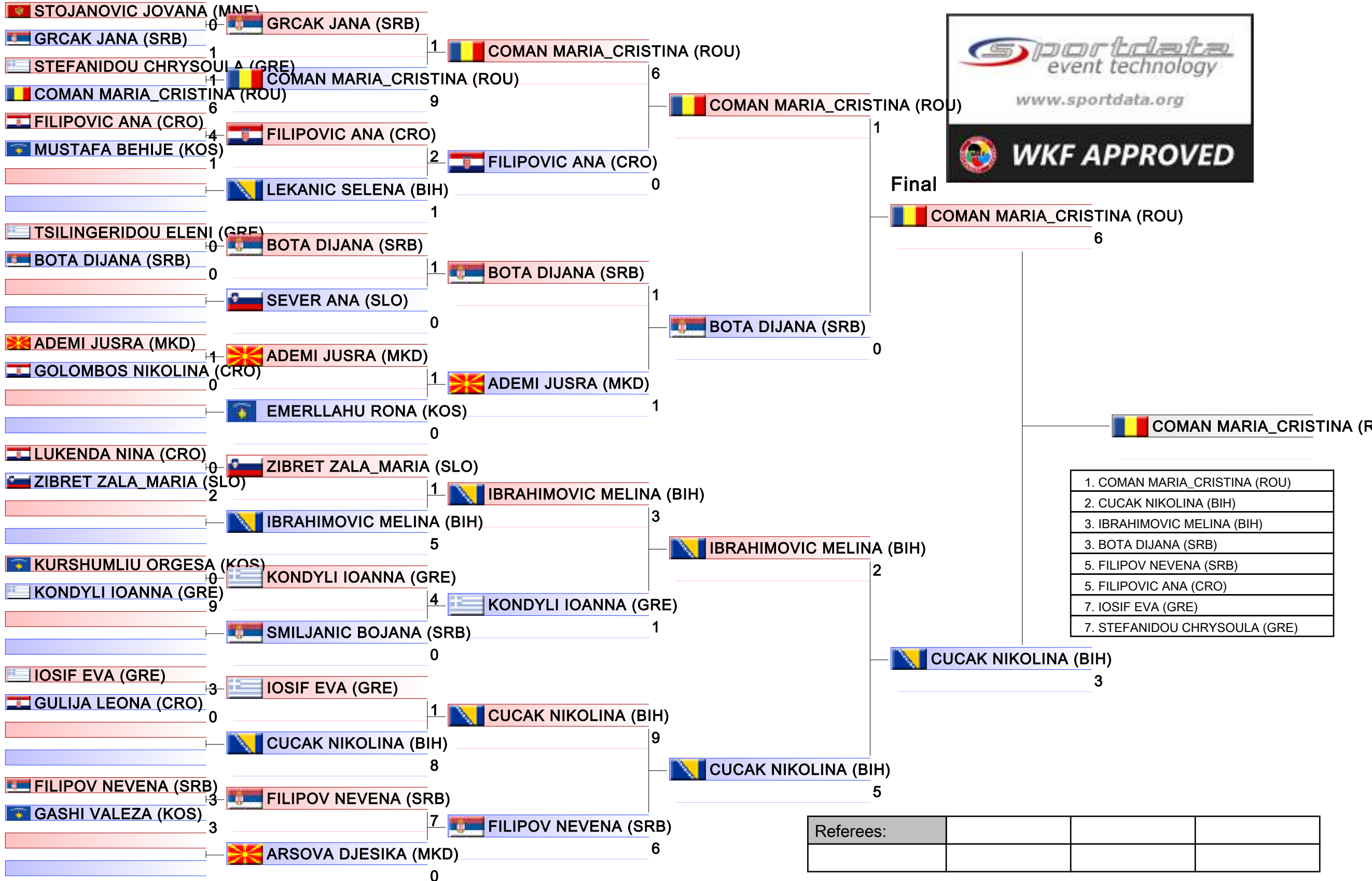

# JUNIOR KUMITE FEMALE 59+ KG

21st Balkan Karate Championships for Cadets, Juniors and U21 - RIJEKA 2021

Tatami  
2 13:15

Pool  
1

(c)sportdata GmbH & Co KG 2000-2021(2021-11-29 16:49) -WKF Approved- v 9.8.8 build 3 (2021-11-04) License: SDIL Sportdata Internal License 2021 (expire 2021-12-31)

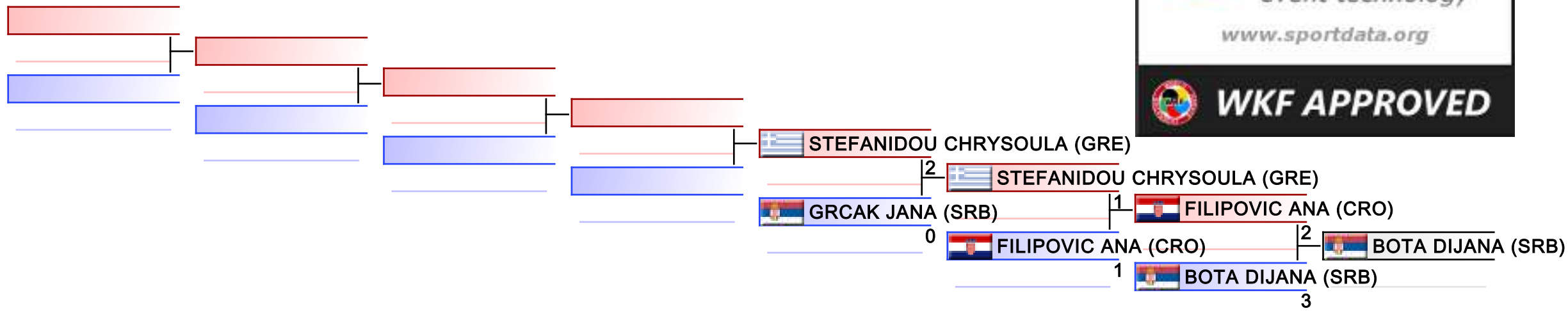

## REPECHAGE: (1)

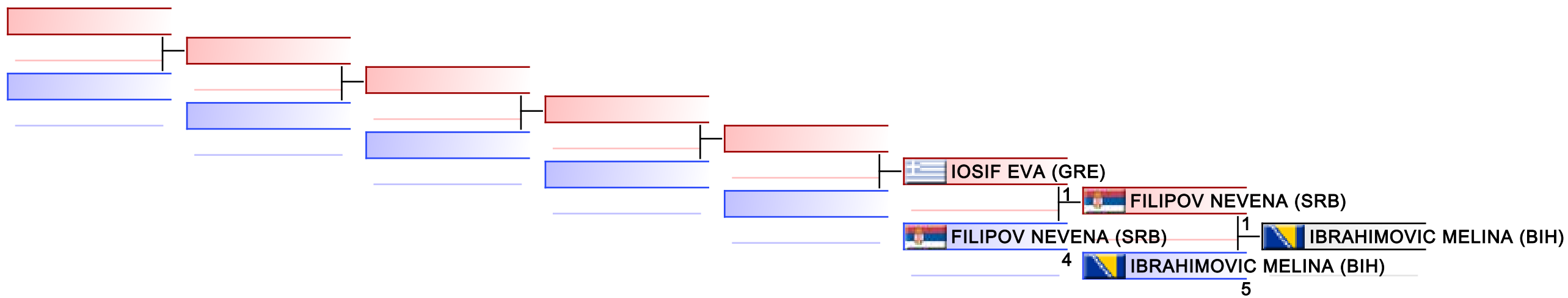

|           |  |  |  |  |  |  |  |
|-----------|--|--|--|--|--|--|--|
| Referees: |  |  |  |  |  |  |  |
|-----------|--|--|--|--|--|--|--|



# JUNIOR KUMITE MALE -55 KG

21st Balkan Karate Championships for Cadets, Juniors and U21 - RIJEKA 2021, RIJEKA, CRO

Tatami  
5 14:25

Pool  
1/1

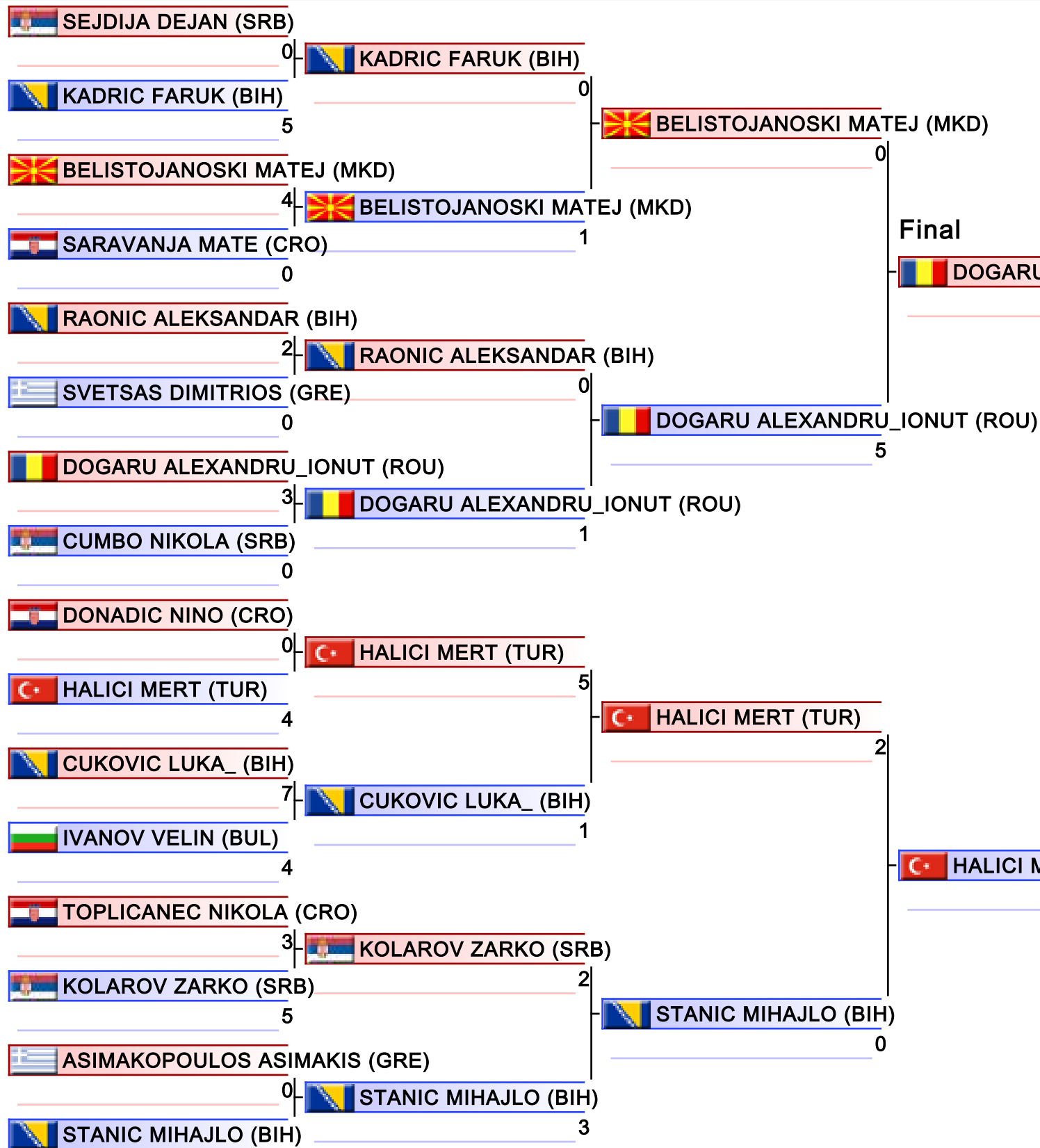

|                                 |
|---------------------------------|
| 1. HALICI MERT (TUR)            |
| 2. DOGARU ALEXANDRU_IONUT (ROU) |
| 3. BELISTOJANOSKI MATEJ (MKD)   |
| 3. STANIC MIHAJLO (BIH)         |
| 5. RAONIC ALEKSANDAR (BIH)      |
| 5. CUKOVIC LUKA_ (BIH)          |
| 7. CUMBO NIKOLA (SRB)           |
| 7. DONADIC NINO (CRO)           |

|           |  |  |  |
|-----------|--|--|--|
| Referees: |  |  |  |
|           |  |  |  |

# JUNIOR KUMITE MALE -55 KG

21st Balkan Karate Championships for Cadets, Juniors and U21 - RIJEKA 2021

Tatami  
5 15:20

Pool  
1

(c)sportdata GmbH & Co KG 2000-2021(2021-11-29 16:49) -WKF Approved- v 9.8.8 build 3 (2021-11-04) License: SDIL Sportdata Internal License 2021 (expire 2021-12-31)

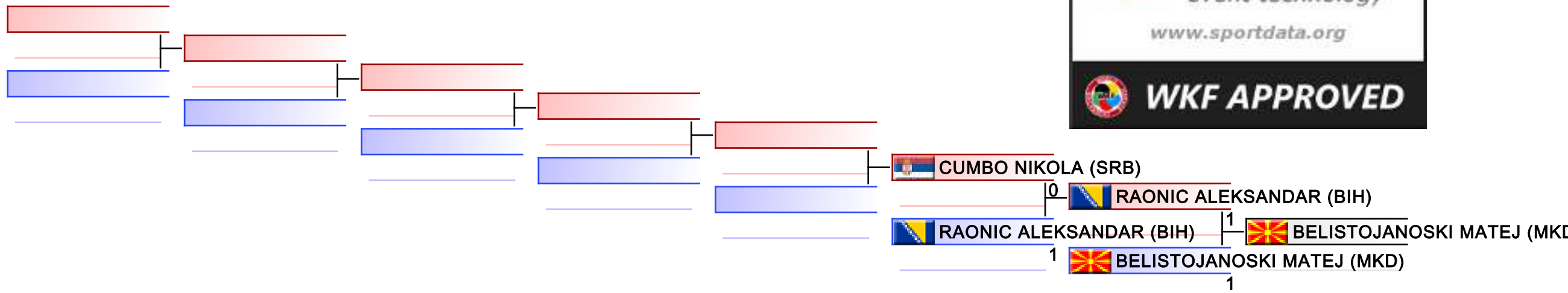

## REPECHAGE: (1)

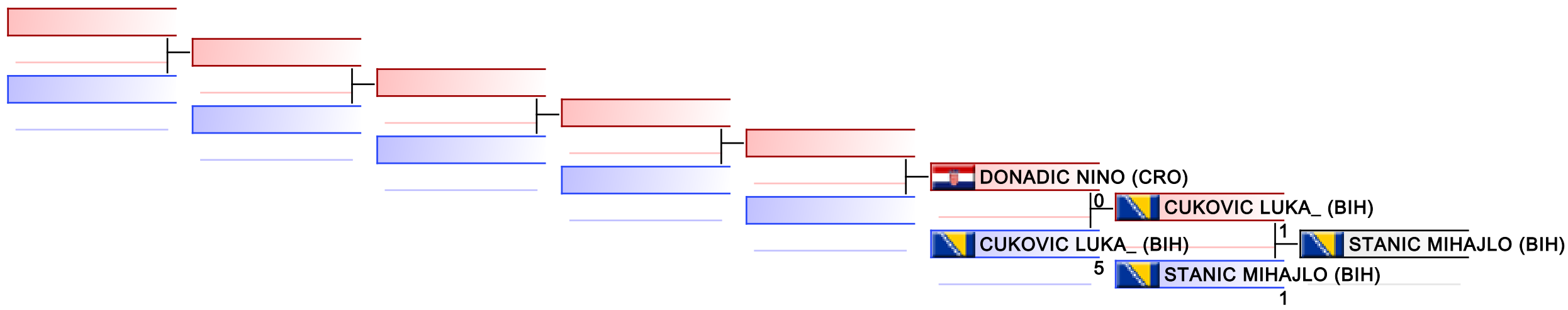

|           |  |  |  |  |  |  |  |
|-----------|--|--|--|--|--|--|--|
| Referees: |  |  |  |  |  |  |  |
|-----------|--|--|--|--|--|--|--|



# JUNIOR KUMITE MALE -61 KG

21st Balkan Karate Championships for Cadets, Juniors and U21 - RIJEKA 2021, RIJEKA, CRO

Tatami  
2 13:55

Pool  
1/1

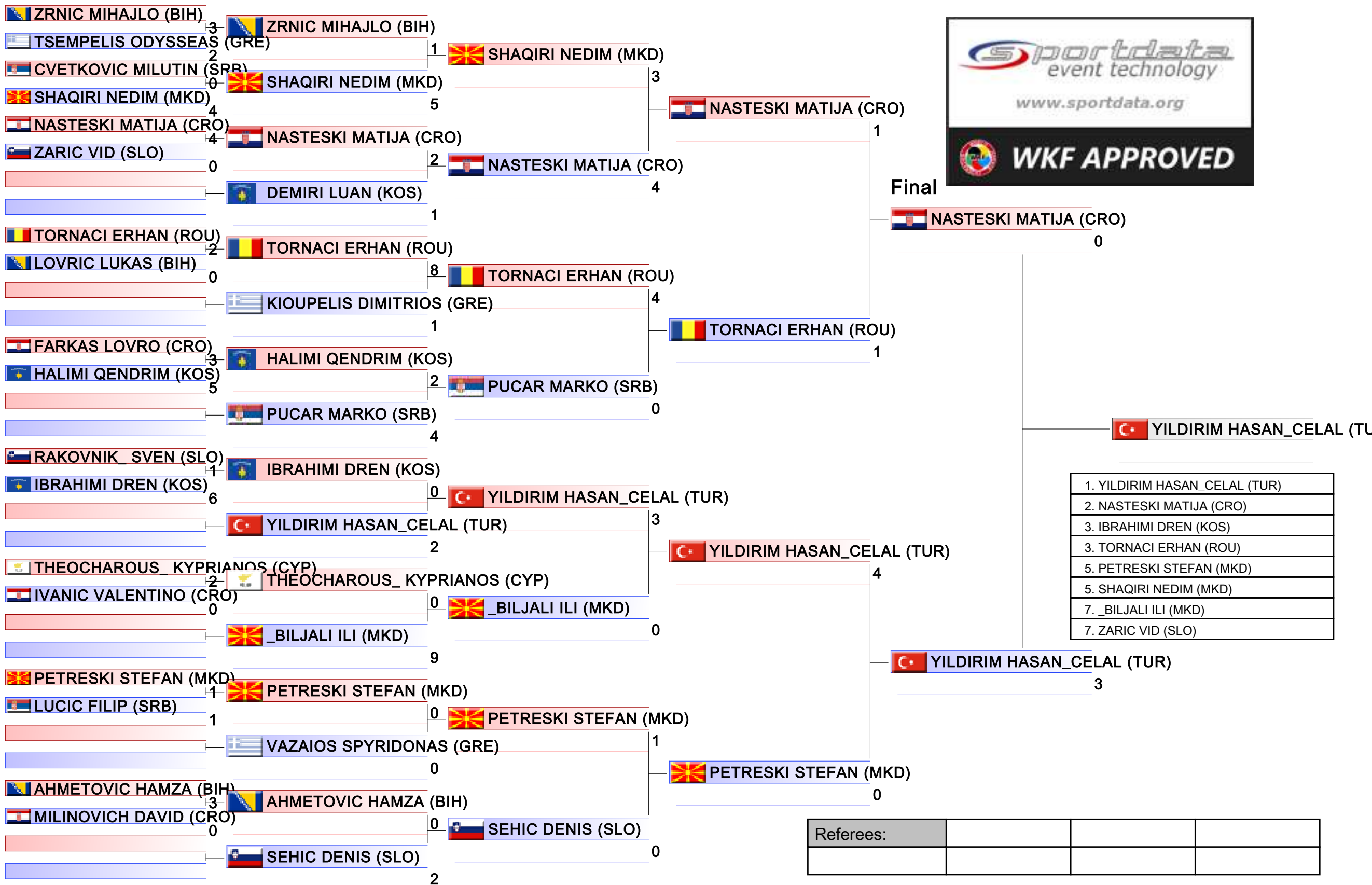

# JUNIOR KUMITE MALE -61 KG

21st Balkan Karate Championships for Cadets, Juniors and U21 - RIJEKA 2021

Tatami  
2 15:30

Pool  
1

(c)sportdata GmbH & Co KG 2000-2021(2021-11-29 16:49) -WKF Approved- v 9.8.8 build 3 (2021-11-04) License: SDIL Sportdata Internal License 2021 (expire 2021-12-31)

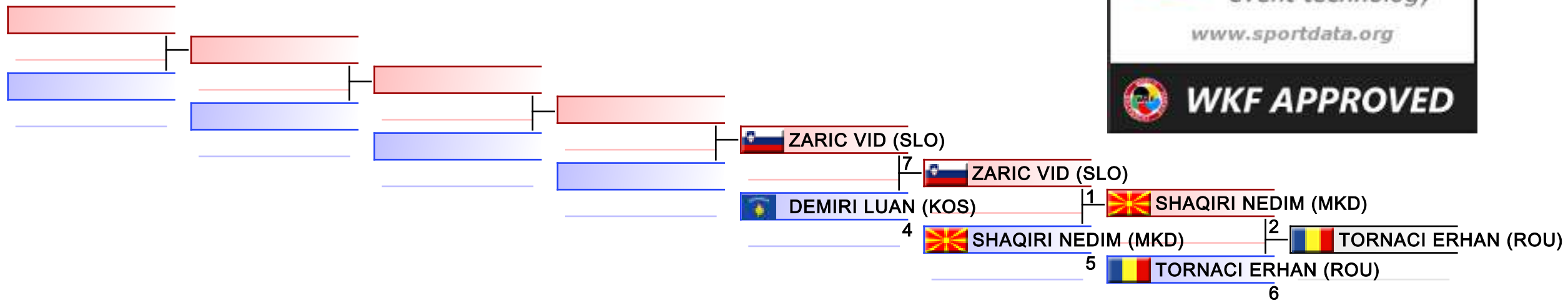

## REPECHAGE: (1)

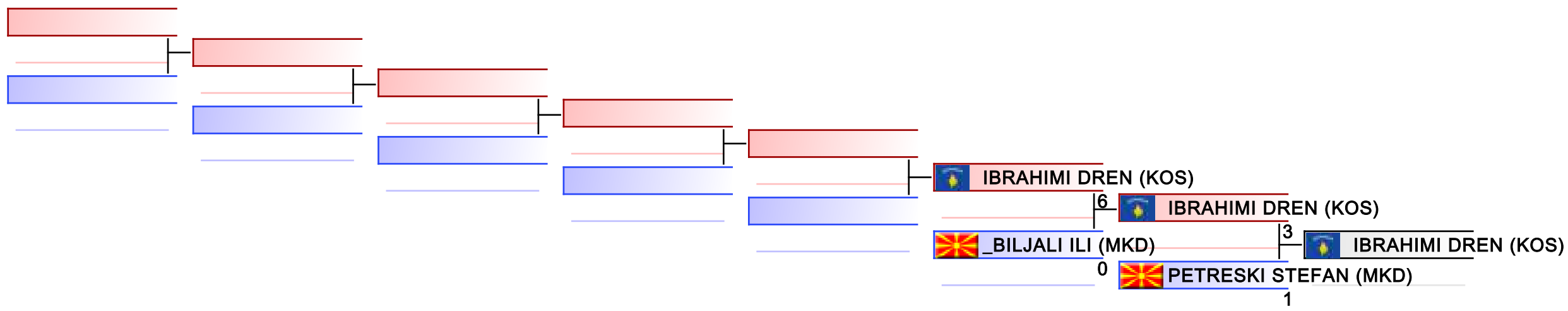

|           |  |  |  |  |  |  |  |
|-----------|--|--|--|--|--|--|--|
| Referees: |  |  |  |  |  |  |  |
|-----------|--|--|--|--|--|--|--|

# JUNIOR KUMITE MALE -68 KG

21st Balkan Karate Championships for Cadets, Juniors and U21 - RIJEKA 2021, RIJEKA, CRO

Tatami  
3 11:00

Pool  
1/2

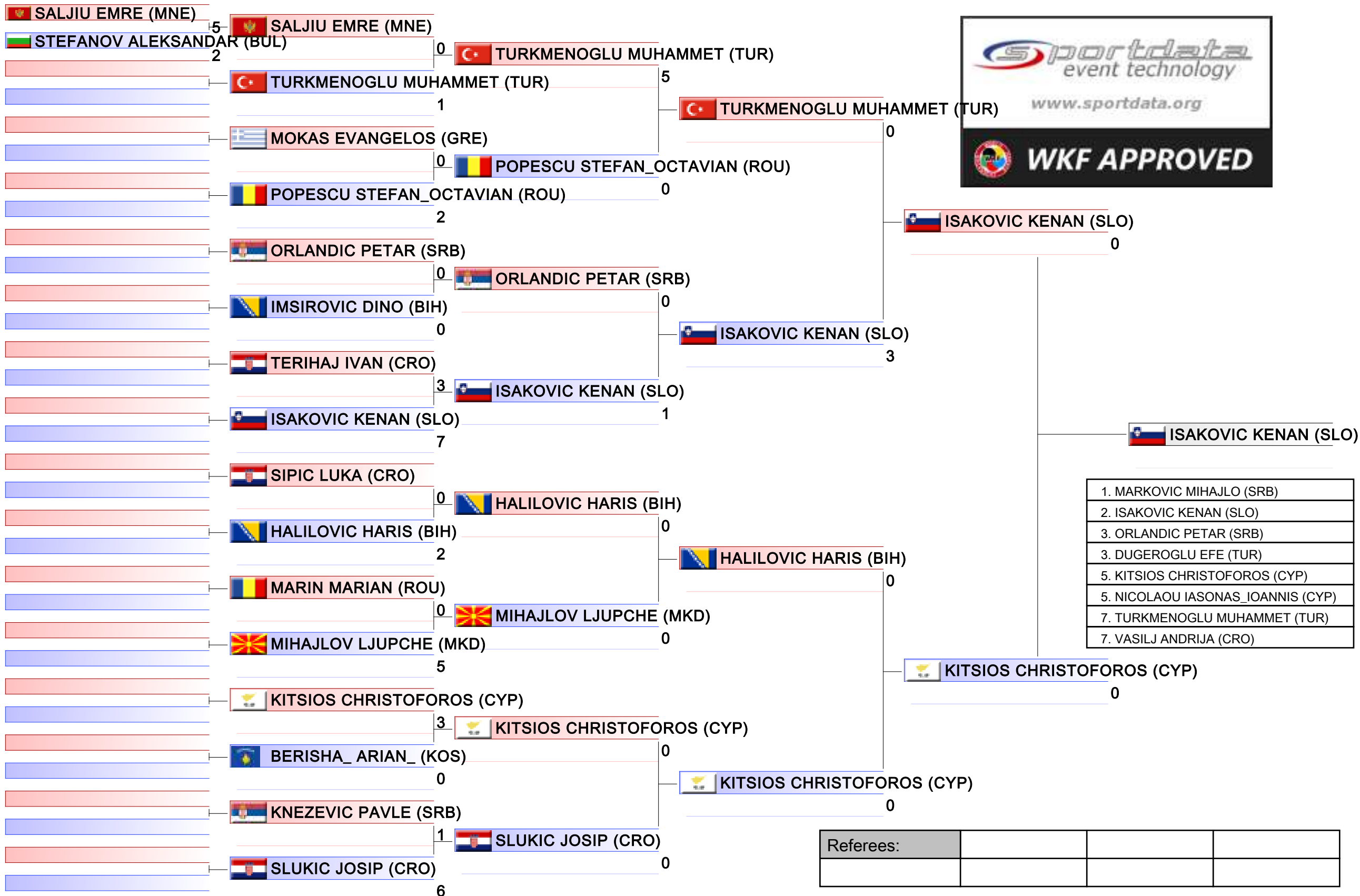

# JUNIOR KUMITE MALE -68 KG

21st Balkan Karate Championships for Cadets, Juniors and U21 - RIJEKA 2021, RIJEKA, CRO

Tatami  
3 12:05

Pool  
2/2

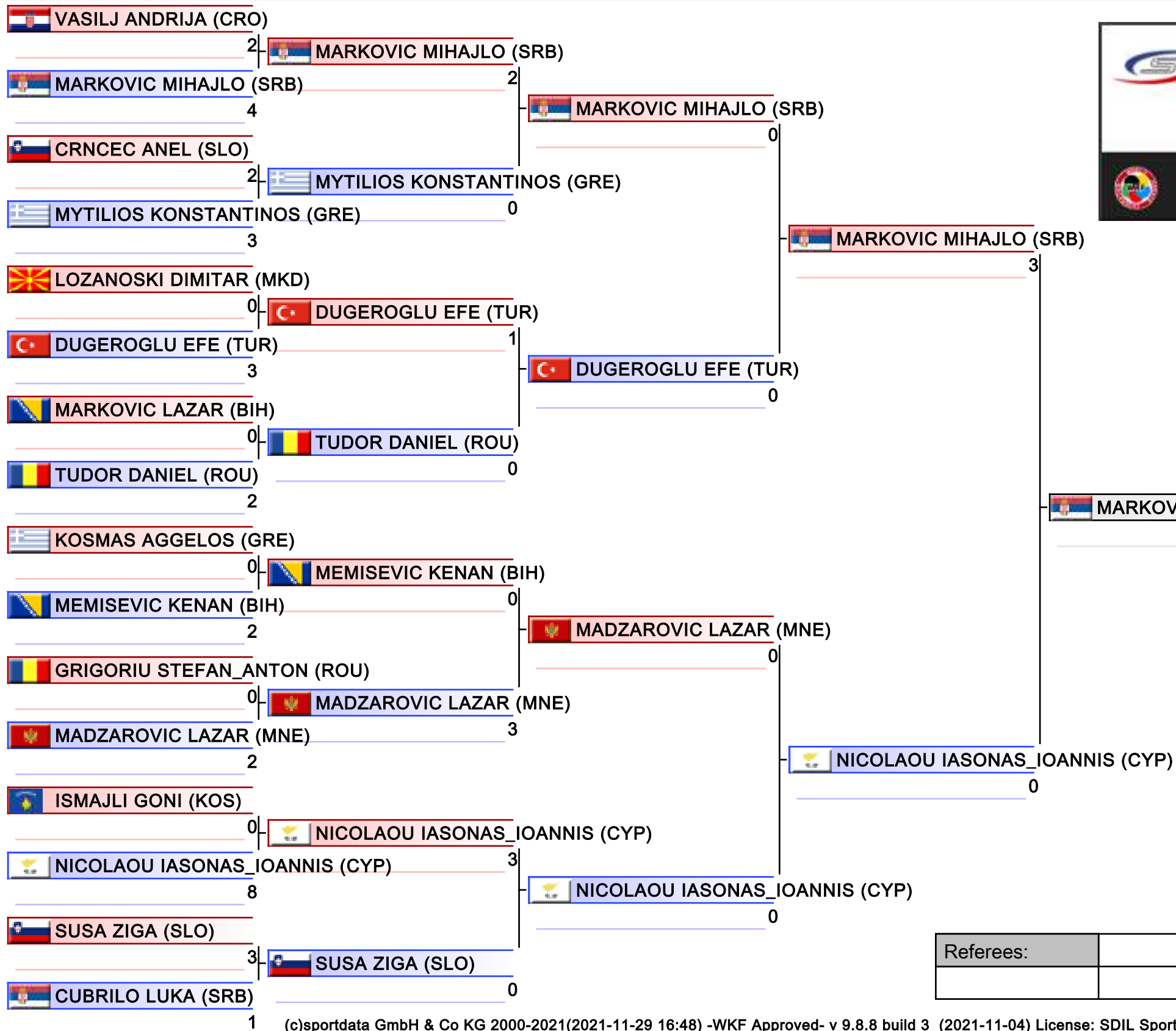

|                                   |
|-----------------------------------|
| 1. MARKOVIC MIHAJLO (SRB)         |
| 2. ISAKOVIC KENAN (SLO)           |
| 3. ORLANDIC PETAR (SRB)           |
| 3. DUGEROGLU EFE (TUR)            |
| 5. KITSIOS CHRISTOFOROS (CYP)     |
| 5. NICOLAOU IASONAS_IOANNIS (CYP) |
| 7. TURKMENOGLU MUHAMMET (TUR)     |
| 7. VASILJ ANDRIJA (CRO)           |

|           |  |  |  |
|-----------|--|--|--|
| Referees: |  |  |  |
|           |  |  |  |

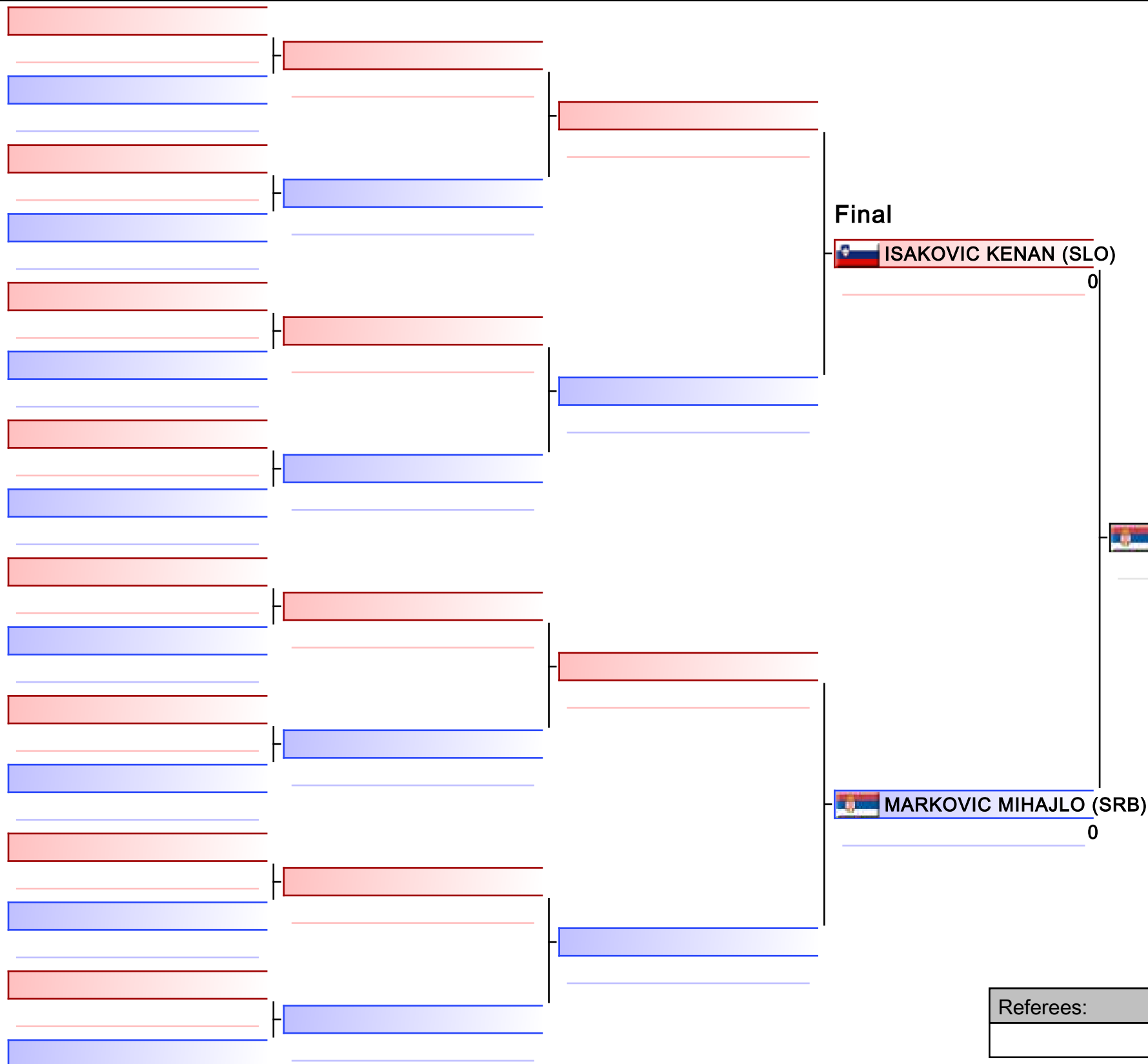

|                                   |
|-----------------------------------|
| 1. MARKOVIC MIHAJLO (SRB)         |
| 2. ISAKOVIC KENAN (SLO)           |
| 3. ORLANDIC PETAR (SRB)           |
| 3. DUGEROGLU EFE (TUR)            |
| 5. KITSIOS CHRISTOFOROS (CYP)     |
| 5. NICOLAOU IASONAS_IOANNIS (CYP) |
| 7. TURKMENOGLU MUHAMMET (TUR)     |
| 7. VASILJ ANDRIJA (CRO)           |

|           |  |  |  |
|-----------|--|--|--|
| Referees: |  |  |  |
|           |  |  |  |

# JUNIOR KUMITE MALE -68 KG

21st Balkan Karate Championships for Cadets, Juniors and U21 - RIJEKA 2021

Tatami  
3 13:05

Pool  
1,2

(c)sportdata GmbH & Co KG 2000-2021(2021-11-29 16:49) -WKF Approved- v 9.8.8 build 3 (2021-11-04) License: SDIL Sportdata Internal License 2021 (expire 2021-12-31)

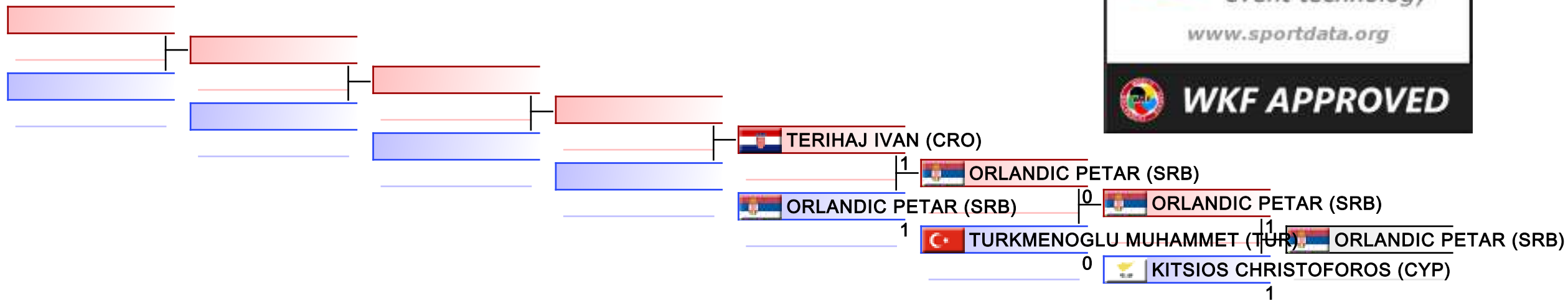

## REPECHAGE: (1,2)

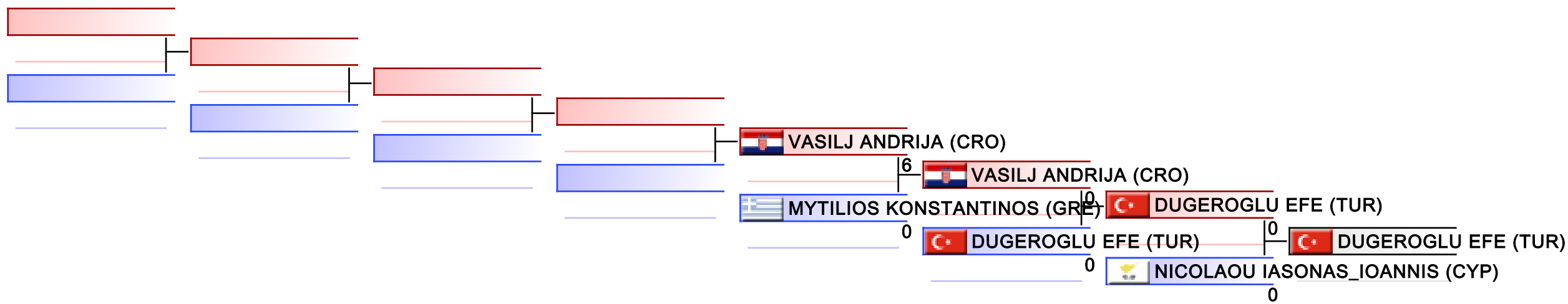

|           |  |  |  |  |  |  |  |
|-----------|--|--|--|--|--|--|--|
| Referees: |  |  |  |  |  |  |  |
|-----------|--|--|--|--|--|--|--|



# JUNIOR KUMITE MALE -76 KG

21st Balkan Karate Championships for Cadets, Juniors and U21 - RIJEKA 2021, RIJEKA, CRO

Tatami  
5 12:15

Pool  
1/1

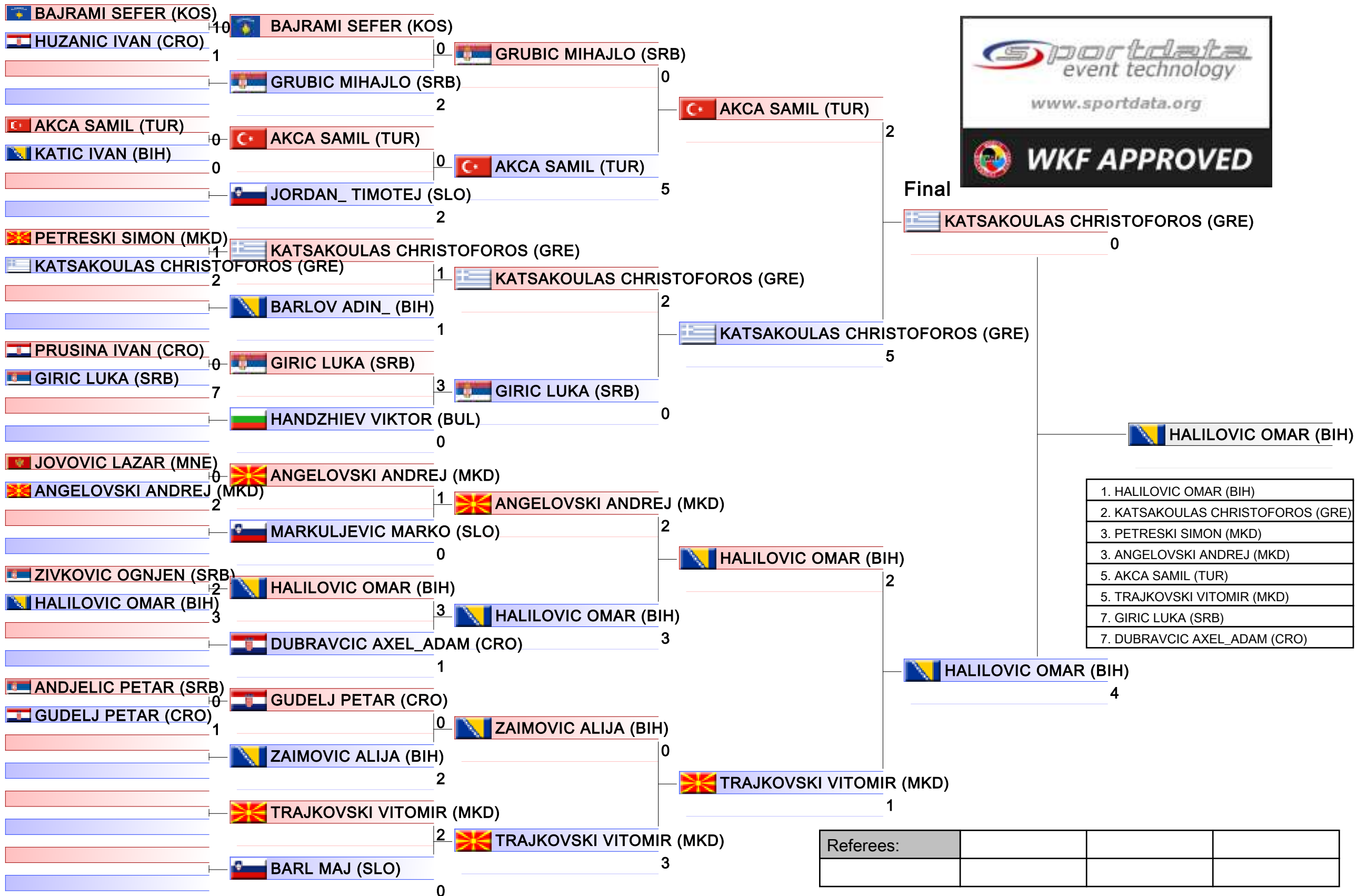

- |                                   |
|-----------------------------------|
| 1. HALILOVIC OMAR (BIH)           |
| 2. KATSAKOULAS CHRISTOFOROS (GRE) |
| 3. PETRESKI SIMON (MKD)           |
| 3. ANGELOVSKI ANDREJ (MKD)        |
| 5. AKCA SAMIL (TUR)               |
| 5. TRAJKOVSKI VITOMIR (MKD)       |
| 7. GIRIC LUKA (SRB)               |
| 7. DUBRAVCIC AXEL_ADAM (CRO)      |

# JUNIOR KUMITE MALE -76 KG

21st Balkan Karate Championships for Cadets, Juniors and U21 - RIJEKA 2021

Tatami  
5 13:40

Pool  
1

(c)sportdata GmbH & Co KG 2000-2021(2021-11-29 16:49) -WKF Approved- v 9.8.8 build 3 (2021-11-04) License: SDIL Sportdata Internal License 2021 (expire 2021-12-31)

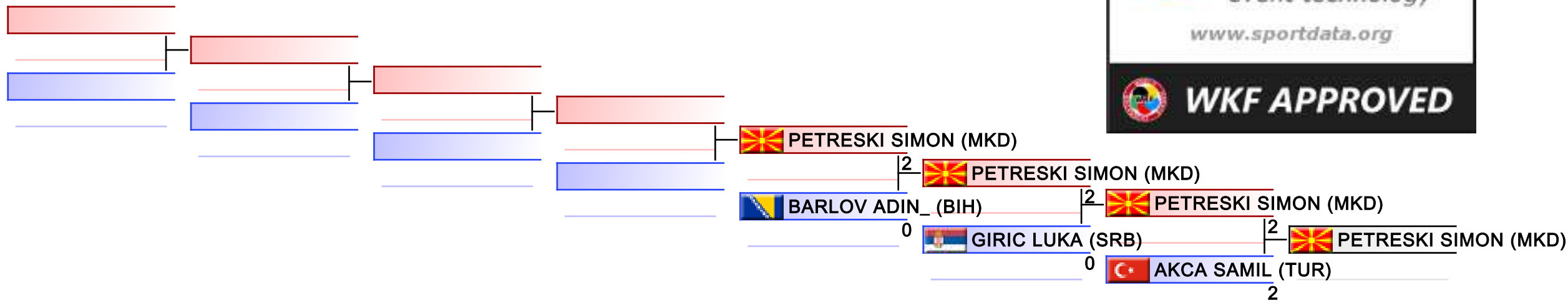

## REPECHAGE: (1)

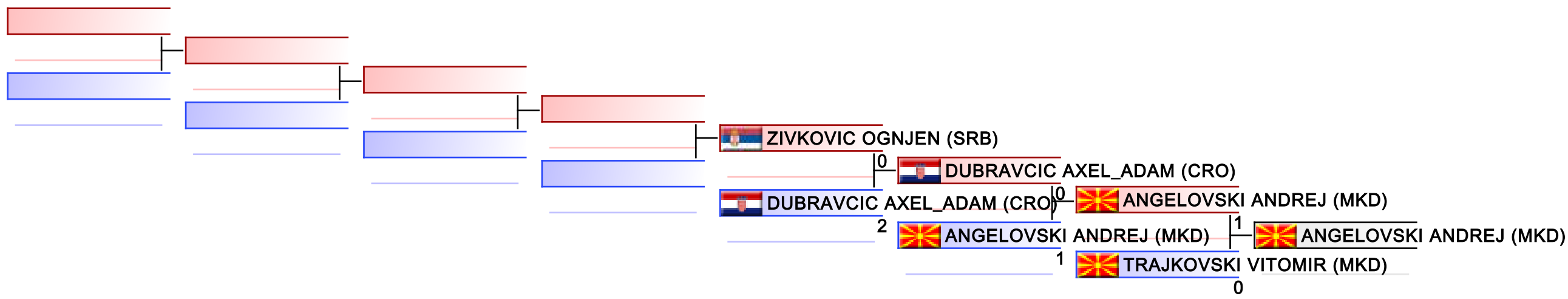

|           |  |  |  |  |  |  |  |
|-----------|--|--|--|--|--|--|--|
| Referees: |  |  |  |  |  |  |  |
|-----------|--|--|--|--|--|--|--|



# JUNIOR KUMITE MALE 76+ KG

21st Balkan Karate Championships for Cadets, Juniors and U21 - RIJEKA 2021, RIJEKA, CRO

Tatami  
5 14:15

Pool  
1/1

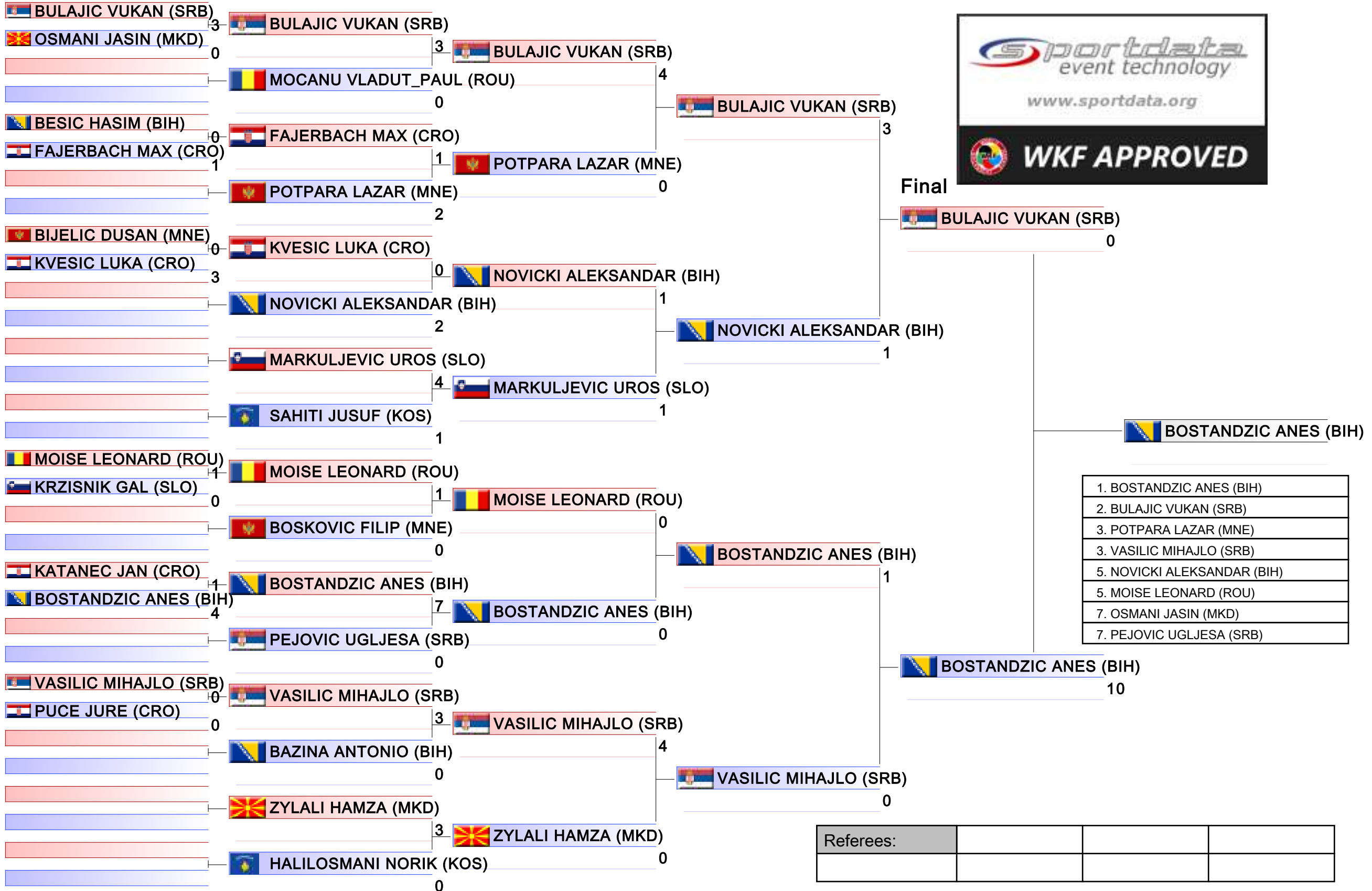

# JUNIOR KUMITE MALE 76+ KG

21st Balkan Karate Championships for Cadets, Juniors and U21 - RIJEKA 2021

Tatami  
5 15:35

Pool  
1

(c)sportdata GmbH & Co KG 2000-2021(2021-11-29 16:49) -WKF Approved- v 9.8.8 build 3 (2021-11-04) License: SDIL Sportdata Internal License 2021 (expire 2021-12-31)

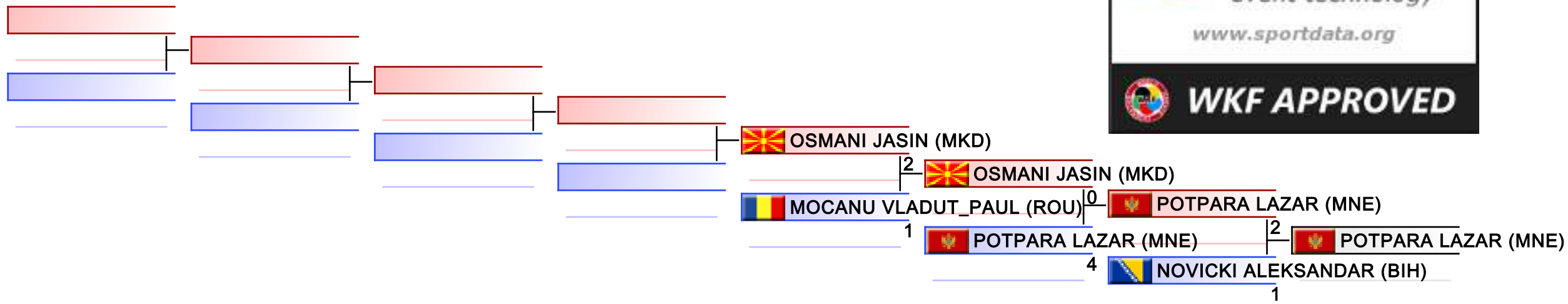

## REPECHAGE: (1)

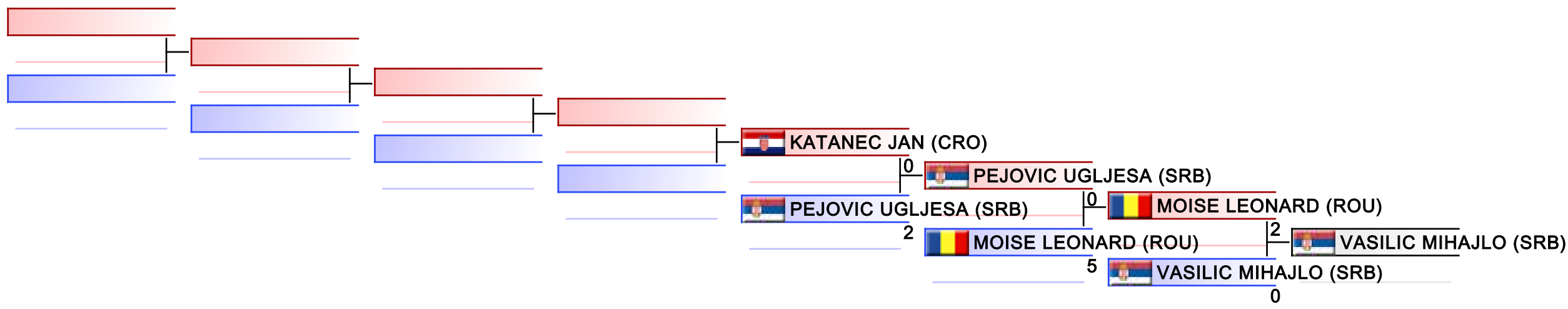

|           |  |  |  |  |  |  |  |
|-----------|--|--|--|--|--|--|--|
| Referees: |  |  |  |  |  |  |  |
|-----------|--|--|--|--|--|--|--|

# JUNIOR KUMITE TEAM FEMALE

21st Balkan Karate Championships for Cadets, Juniors and U21 - RIJEKA 2021, RIJEKA, CRO

Tatami  
6 09:00

Pool  
1/1

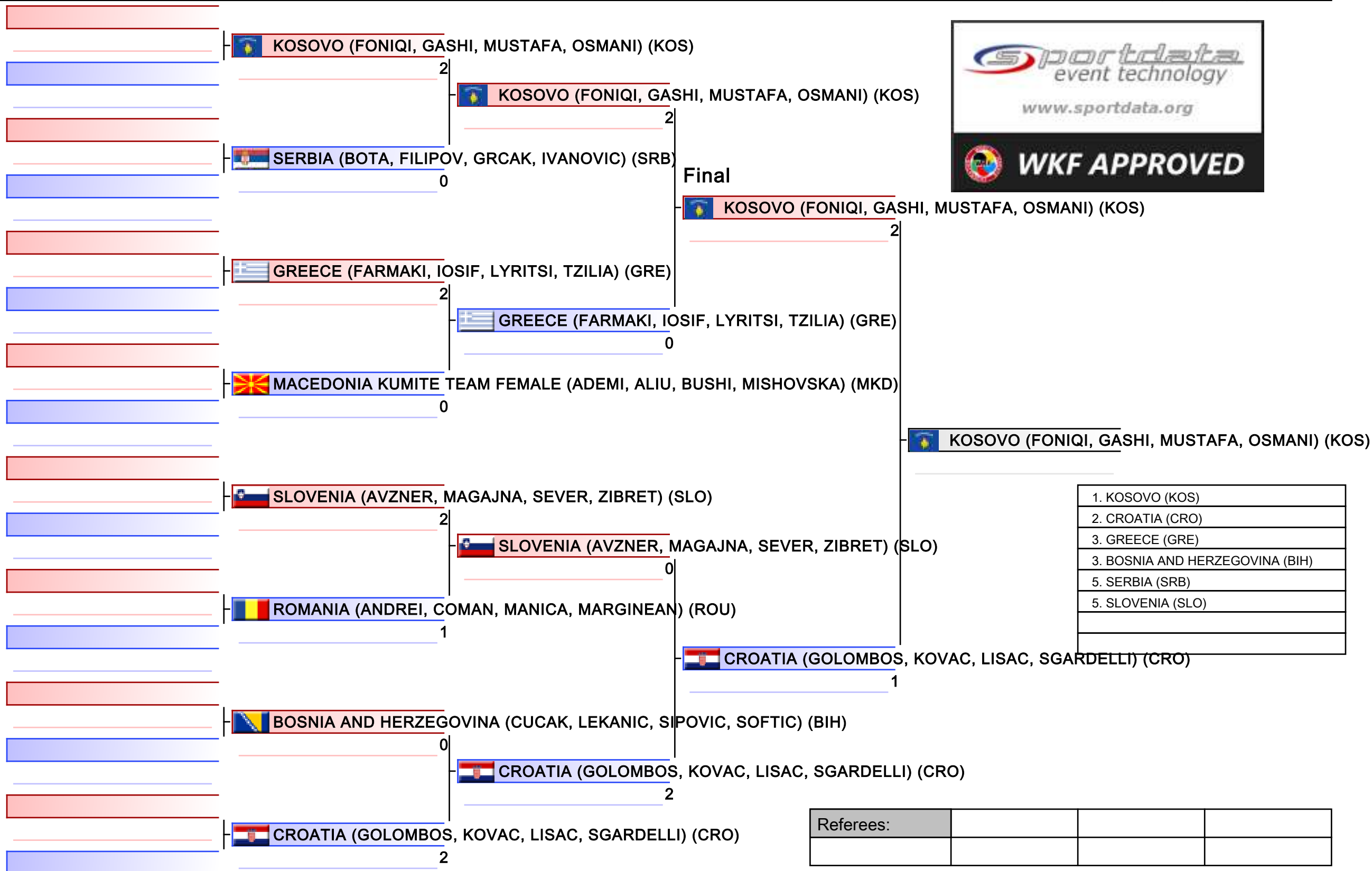

# JUNIOR KUMITE TEAM FEMALE

21st Balkan Karate Championships for Cadets, Juniors and U21 - RIJEKA 2021

Tatami  
6 11:00

Pool  
1

(c)sportdata GmbH & Co KG 2000-2021(2021-11-29 16:49) -WKF Approved- v 9.8.8 build 3 (2021-11-04) License: SDIL Sportdata Internal License 2021 (expire 2021-12-31)

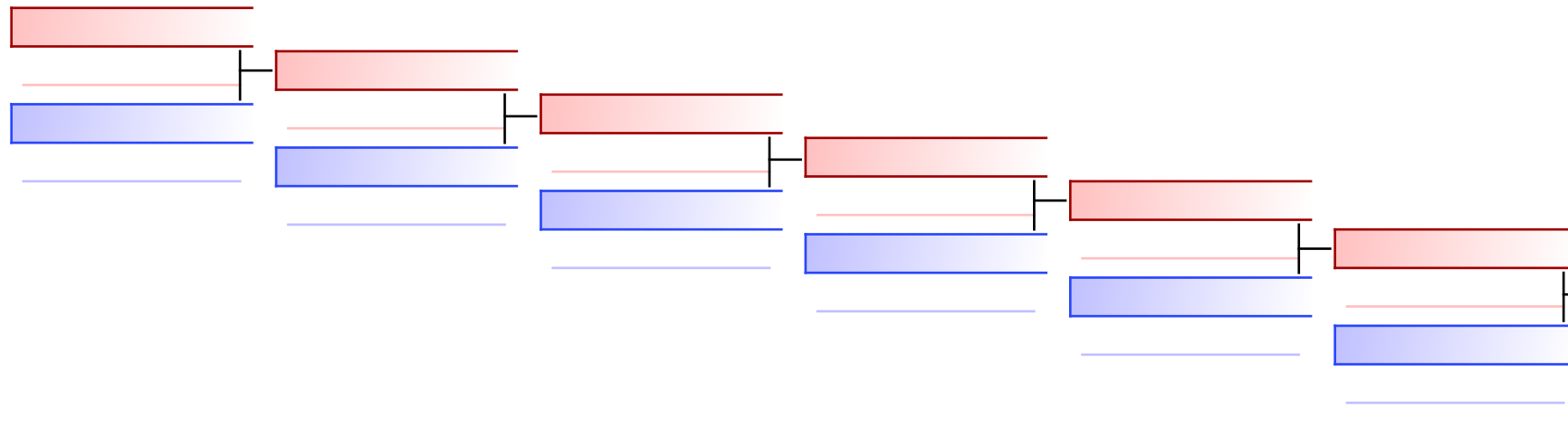

SERBIA (BOTA, FILIPOV, GRCAK, IVANOVIC) (SRB)  
0  
 GREECE (FARMAKI, IOSIF, LYRITSIS, TZILIA) (GRE)  
2

## REPECHAGE: (1)

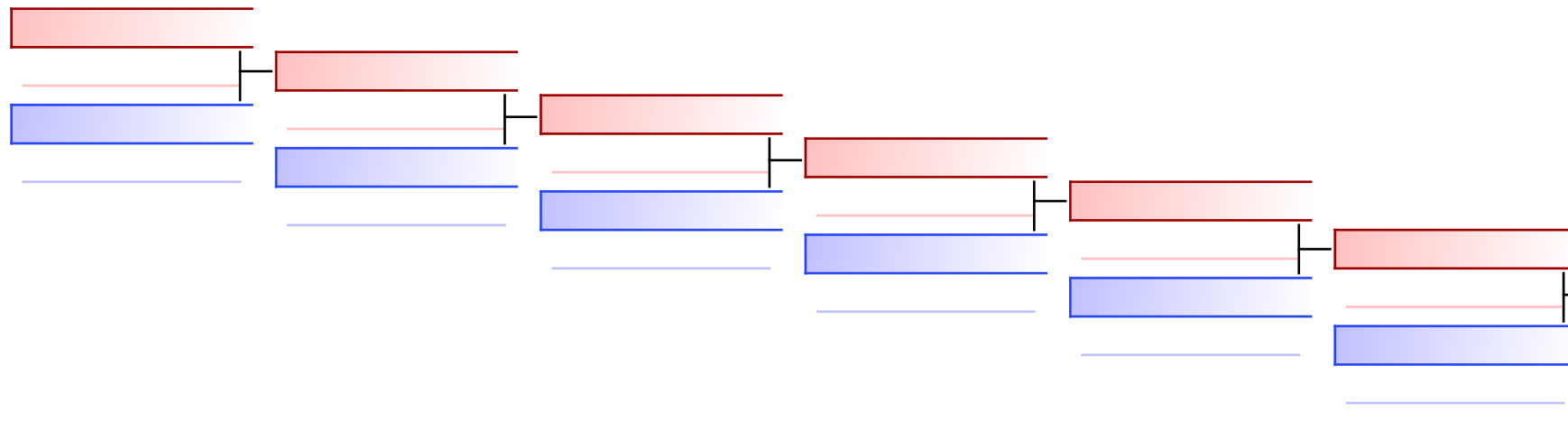

BOSNIA AND HERZEGOVINA (CUCAK, LEKANIC, S...)  
2  
 SLOVENIA (AVZNER, MAGAJNA, SEVER, ZIBRET)  
0

|           |  |  |  |  |  |  |  |
|-----------|--|--|--|--|--|--|--|
| Referees: |  |  |  |  |  |  |  |
|-----------|--|--|--|--|--|--|--|

# JUNIOR KUMITE TEAM MALE

21st Balkan Karate Championships for Cadets, Juniors and U21 - RIJEKA 2021, RIJEKA, CRO

Tatami  
2 09:00

Pool  
1/1

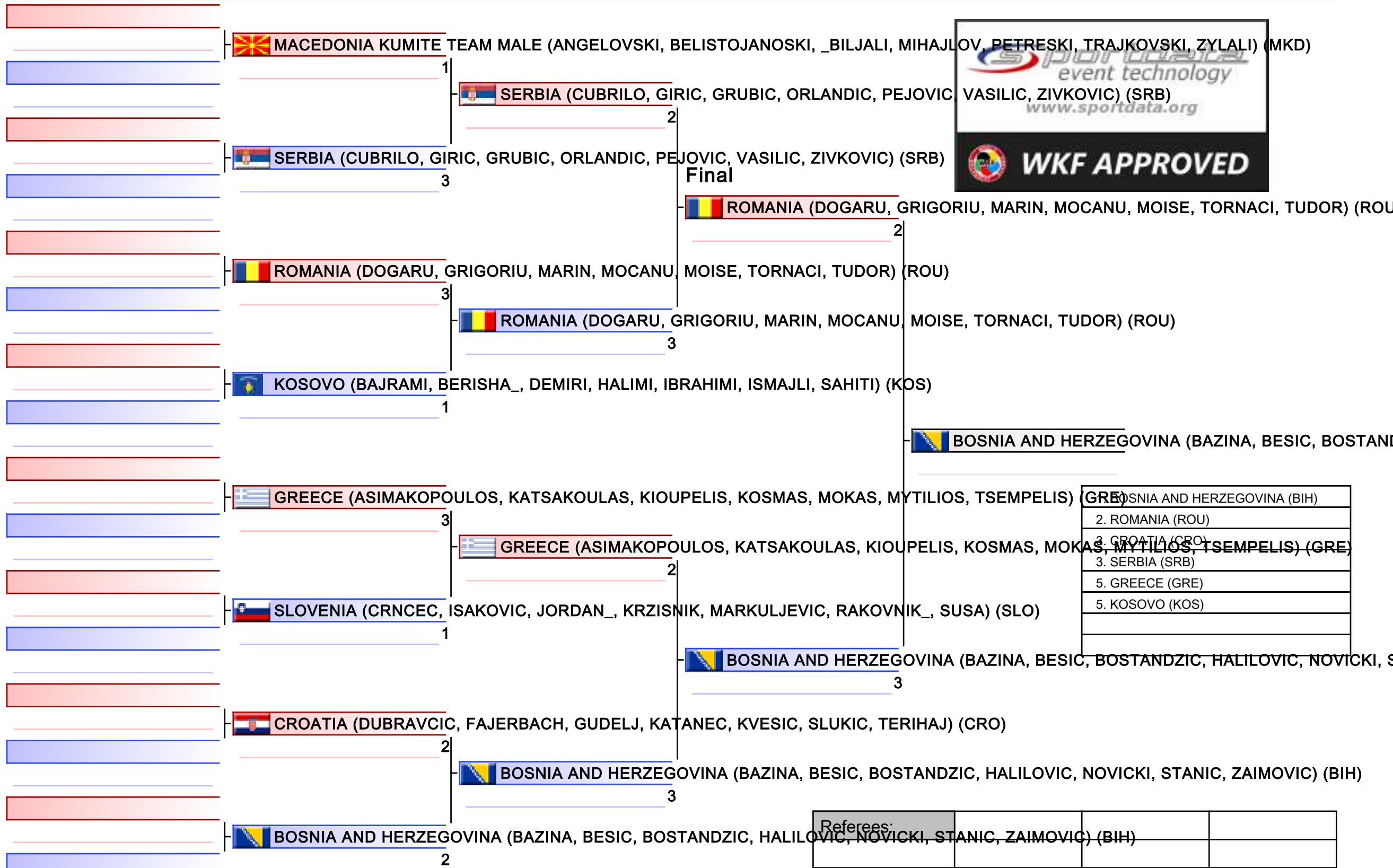

|                                 |
|---------------------------------|
| 1. BOSNIA AND HERZEGOVINA (BIH) |
| 2. ROMANIA (ROU)                |
| 3. CROATIA (CRO)                |
| 3. SERBIA (SRB)                 |
| 5. GREECE (GRE)                 |
| 5. KOSOVO (KOS)                 |
|                                 |
|                                 |

|           |  |  |  |
|-----------|--|--|--|
| Referees: |  |  |  |
|           |  |  |  |

# JUNIOR KUMITE TEAM MALE

21st Balkan Karate Championships for Cadets, Juniors and U21 - RIJEKA 2021

Tatami  
2 11:30

Pool  
1

(c)sportdata GmbH & Co KG 2000-2021(2021-11-29 16:49) -WKF Approved- v 9.8.8 build 3 (2021-11-04) License: SDIL Sportdata Internal License 2021 (expire 2021-12-31)

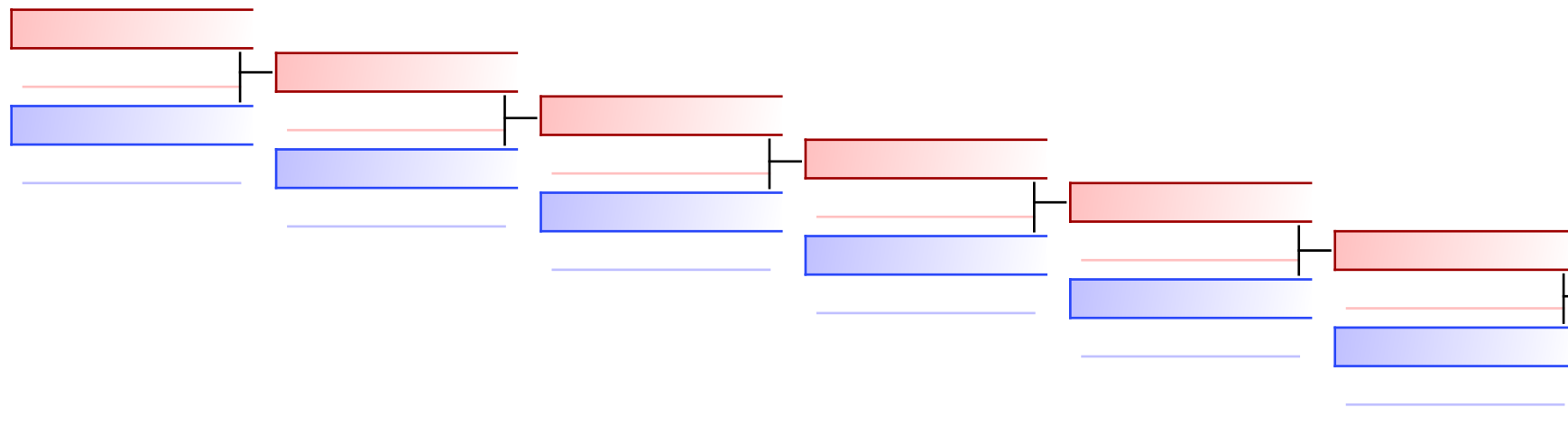

KOSOVO (BAJRAMI, BERISHA\_, DEMIRI, HALIMI, IDRI  
 0  
 SERBIA (CUBRILO, GIRIC, GRUBIC, ORLANDIC, PE  
 9

## REPECHAGE: (1)

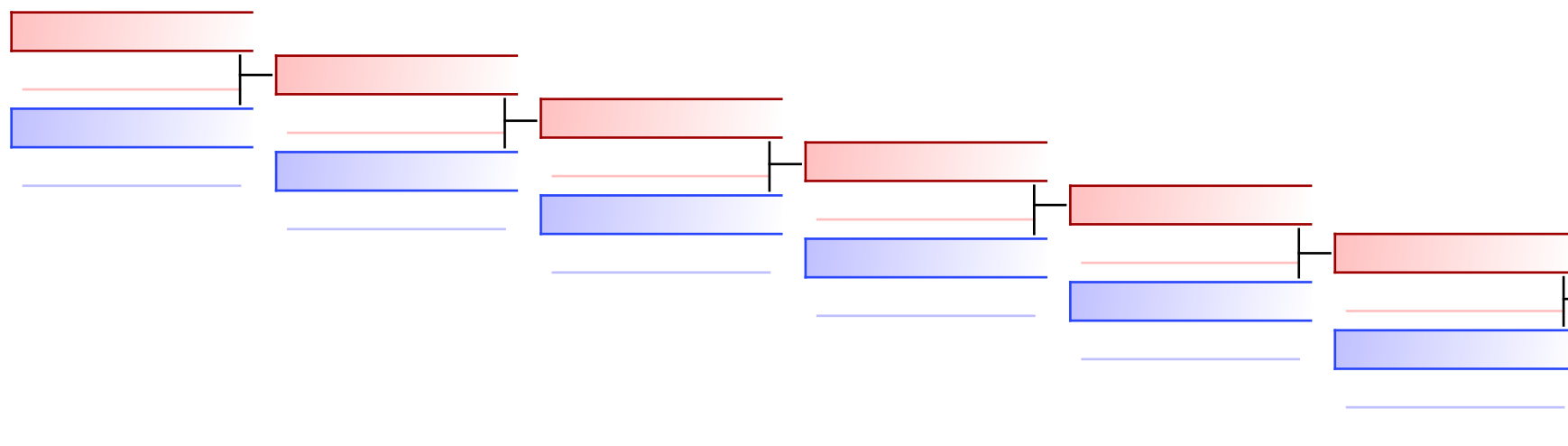

CROATIA (DUBRAVCIC, FAJERBACH, GUDELJ, KA  
 3  
 CROATIA (DUBRAVCIC, FAJER  
 0  
 GREECE (ASIMAKOPOULOS, KATSAKOULAS, KIOU

|           |  |  |  |  |  |  |  |
|-----------|--|--|--|--|--|--|--|
| Referees: |  |  |  |  |  |  |  |
|-----------|--|--|--|--|--|--|--|

**21st Balkan Karate Championships for Cadets,  
Juniors and U21 - RIJEKA 2021 - 2021-11-26**

**KATA TEAM CADET AND JUNIOR FEMALE**

**R1 G1/2 (3) Tatami 4 09:00**

| Competitors  | Kata              | 1T  | 1A  | 2T    | 2A    | 3T    | 3A    | 4T    | 4A    | 5T  | 5A  | 6T | 6A | 7T | 7A | TEC   | ATH  | Extra | Total Rank |
|--|-------------------|-----|-----|-------|-------|-------|-------|-------|-------|-----|-----|----|----|----|----|-------|------|-------|------------|
| 1 BOSNIA AND HERZEGOVINA (PESTALIC, SALIHOVIC, STANOJEVIC) (BIH) | 078 SANSAI        | 7.8 | 7.6 | 7.6   | 7.8   | (7.0) | (6.8) | (8.0) | (8.0) | 7.2 | 7.4 |    |    |    |    | 15.82 | 6.84 |       | 22.663     |
| 2 CROATIA (GRGIC, HORVAT, PALIAGA) (CRO)                         | 021 GOJUSHIHO SHO | 8.0 | 7.6 | 7.8   | 7.6   | (6.8) | (7.2) | (8.4) | (8.4) | 7.6 | 7.8 |    |    |    |    | 16.38 | 6.9  |       | 23.282     |
| 3 SERBIA (GRBIC, JOVANOVIC, MILOSEVIC) (SRB)                     | 021 GOJUSHIHO SHO | 8.2 | 8.0 | (6.2) | (6.8) | (8.4) | (8.6) | 8.2   | 8.2   | 7.8 | 7.8 |    |    |    |    | 16.94 | 7.2  |       | 24.141     |

**R1 G2/2 (2) Tatami 4 09:15**

| Competitors                                 | Kata                    | 1T    | 1A    | 2T    | 2A    | 3T    | 3A    | 4T  | 4A  | 5T  | 5A  | 6T | 6A | 7T | 7A | TEC   | ATH  | Extra | Total Rank |
|---|-------------------------|-------|-------|-------|-------|-------|-------|-----|-----|-----|-----|----|----|----|----|-------|------|-------|------------|
| 1 GREECE (PAPPA, PAVLITINA, XENOU_) (GRE)   | 008 CHATANYARA KUSHANKU | (8.0) | 7.8   | 8.0   | (8.0) | (7.4) | (7.6) | 8.0 | 8.0 | 7.6 | 7.8 |    |    |    |    | 16.52 | 7.08 |       | 23.6 2     |
| 2 TURKEY (KOYUNCU, PEHLIVAN, TUREMEN) (TUR) | 021 GOJUSHIHO SHO       | 8.2   | (8.0) | (8.4) | (8.4) | (7.8) | 8.0   | 8.2 | 8.2 | 8.2 | 8.0 |    |    |    |    | 17.22 | 7.26 |       | 24.481     |

**R2 Bronze Medal Match 1 Tatami 4 09:25**

| Competitors                              | Kata | 1T  | 1A | 2T | 2A | 3T | 3A | 4T | 4A | 5T | 5A | 6T | 6A | 7T | 7A | TEC | ATH | Extra | Total Rank |
|--|------|-----|----|----|----|----|----|----|----|----|----|----|----|----|----|-----|-----|-------|------------|
| 1 CROATIA (GRGIC, HORVAT, PALIAGA) (CRO) |      | 1.0 |    |    |    |    |    |    |    |    |    |    |    |    |    | 1.0 |     |       | 1.0 1      |

**R2 Bronze Medal Match 2 Tatami 4 09:35**

| Competitors  | Kata      | 1T  | 1A  | 2T    | 2A  | 3T    | 3A    | 4T  | 4A    | 5T    | 5A    | 6T | 6A | 7T | 7A | TEC   | ATH  | Extra | Total Rank |
|--|-----------|-----|-----|-------|-----|-------|-------|-----|-------|-------|-------|----|----|----|----|-------|------|-------|------------|
| 1 BOSNIA AND HERZEGOVINA (PESTALIC, SALIHOVIC, STANOJEVIC) (BIH) | 099 UNSU  | 7.6 | 7.4 | (7.4) | 7.4 | (8.4) | (8.2) | 7.4 | (7.2) | 8.2   | 8.2   |    |    |    |    | 16.24 | 6.9  |       | 23.142     |
| 2 GREECE (PAPPA, PAVLITINA, XENOU_) (GRE)                        | 067 PAIKU | 8.0 | 7.8 | 8.2   | 8.2 | (7.4) | (7.4) | 8.4 | 8.4   | (9.0) | (9.0) |    |    |    |    | 17.22 | 7.32 |       | 24.541     |

**R2 Gold Medal Match Tatami 4 09:45**

| Competitors                                  | Kata              | 1T  | 1A    | 2T  | 2A  | 3T    | 3A    | 4T  | 4A  | 5T    | 5A  | 6T | 6A | 7T | 7A | TEC  | ATH  | Extra | Total Rank |
|--|-------------------|-----|-------|-----|-----|-------|-------|-----|-----|-------|-----|----|----|----|----|------|------|-------|------------|
| 1 SERBIA (GRBIC, JOVANOVIC, MILOSEVIC) (SRB) | 020 GOJUSHIHO DAI |     |       |     |     |       |       |     |     |       |     |    |    |    |    |      |      |       |            |
| 2 TURKEY (KOYUNCU, PEHLIVAN, TUREMEN) (TUR)  | 099 UNSU          | 8.2 | (8.0) | 8.4 | 8.4 | (8.8) | (8.8) | 8.4 | 8.4 | (8.0) | 8.0 |    |    |    |    | 17.5 | 7.44 |       | 24.941     |

**Results**

|   |   |                        |   |                        |
|---|---|------------------------|---|------------------------|
| 1 | TURKEY<br>- TUREMEN DAMLA_SU<br>- PEHLIVAN ASLI_BASAK<br>- KOYUNCU PERI                       | TURKEY                 |  | TURKEY                 |
| 2 | SERBIA<br>- MILOSEVIC NEDA<br>- JOVANOVIC SAVA<br>- GRBIC GORDANA                             | SERBIA                 |  | SERBIA                 |
| 3 | CROATIA<br>- GRGIC INGA<br>- HORVAT STELA<br>- PALIAGA FLAVIA                                 | CROATIA                |  | CROATIA                |
| 3 | GREECE<br>- PAPPA CHRISTINA_TRIADA<br>- PAVLITINA MARIA<br>- XENOU_LYDIA_LAMPRINI             | GREECE                 |  | GREECE                 |
| 5 | BOSNIA AND HERZEGOVINA<br>- PESTALIC MERJEMA<br>- SALIHOVIC ALDIJANA<br>- STANOJEVIC KRISTINA | BOSNIA AND HERZEGOVINA |  | BOSNIA AND HERZEGOVINA |



**21st Balkan Karate Championships for Cadets,  
Juniors and U21 - RIJEKA 2021 - 2021-11-26  
KATA TEAM CADET AND JUNIOR MALE**

**R1 G1/2 (3) Tatami 5 09:00**

| Competitors                                     | Kata              | 1T    | 1A    | 2T    | 2A  | 3T    | 3A    | 4T  | 4A    | 5T  | 5A  | 6T | 6A | 7T | 7A | TEC   | ATH  | Extra | Total Rank |
|---|-------------------|-------|-------|-------|-----|-------|-------|-----|-------|-----|-----|----|----|----|----|-------|------|-------|------------|
| 1 CROATIA (BRAVARIC_CILO, KEKO, PARLOV) (CRO)   | 099 UNSU          | (7.6) | 7.8   | 7.8   | 7.8 | (8.6) | (8.6) | 7.6 | (7.6) | 7.6 | 7.8 |    |    |    |    | 16.1  | 7.02 |       | 23.123     |
| 2 TURKEY (AKBABA, ASLAN, KILIC) (TUR)           | 002 ANAN DAI      | (8.0) | (8.2) | 8.6   | 8.6 | (9.2) | (9.2) | 8.8 | 8.8   | 8.0 | 8.2 |    |    |    |    | 17.78 | 7.68 |       | 25.461     |
| 3 MONTENEGRO (GERSCHWITZ, JANJIC, MILIC_) (MNE) | 021 GOJUSHIHO SHO | (7.8) | (8.0) | (8.2) | 8.0 | 8.2   | (8.2) | 8.0 | 8.0   | 7.8 | 8.0 |    |    |    |    | 16.8  | 7.2  |       | 24.0 2     |

**R1 G2/2 (3) Tatami 5 09:15**

| Competitors  | Kata              | 1T  | 1A    | 2T    | 2A    | 3T    | 3A  | 4T    | 4A    | 5T  | 5A  | 6T | 6A | 7T | 7A | TEC   | ATH  | Extra | Total Rank |
|--|-------------------|-----|-------|-------|-------|-------|-----|-------|-------|-----|-----|----|----|----|----|-------|------|-------|------------|
| 1 MACEDONIA KATA TEAM MALE (ANDRIC, SPASOVSKI, STOJANOSKI) (MKD) | 021 GOJUSHIHO SHO | 8.2 | (8.0) | (7.8) | 8.0   | 8.4   | 8.4 | (8.8) | (8.8) | 8.4 | 8.4 |    |    |    |    | 17.5  | 7.44 |       | 24.941     |
| 2 BOSNIA AND HERZEGOVINA (LUGONIC, MEHULJIC, ROSIC) (BIH)        | 012 ENPI          | 1.1 |       |       |       |       |     |       |       |     |     |    |    |    |    | 1.1   |      |       | 1.1 3      |
| 3 SERBIA (BOSKOV, NIKOLIC, PAVLOVIC) (SRB)                       | 021 GOJUSHIHO SHO | 8.0 | 8.0   | (7.6) | (7.8) | (8.2) | 8.2 | 8.0   | (8.4) | 8.2 | 8.0 |    |    |    |    | 16.94 | 7.26 |       | 24.2 2     |

**R2 Bronze Medal Match 1 Tatami 5 09:30**

| Competitors   | Kata          | 1T    | 1A    | 2T    | 2A    | 3T  | 3A  | 4T    | 4A  | 5T  | 5A  | 6T | 6A | 7T | 7A | TEC   | ATH  | Extra | Total Rank |
|---|---------------|-------|-------|-------|-------|-----|-----|-------|-----|-----|-----|----|----|----|----|-------|------|-------|------------|
| 1 MONTENEGRO (GERSCHWITZ, JANJIC, MILIC_) (MNE)           | 099 UNSU      | (8.4) | (8.4) | (7.4) | (7.2) | 8.4 | 8.2 | 8.2   | 8.0 | 7.8 | 8.0 |    |    |    |    | 17.08 | 7.26 |       | 24.341     |
| 2 BOSNIA AND HERZEGOVINA (LUGONIC, MEHULJIC, ROSIC) (BIH) | 041 KANKU SHO | 7.8   | (8.0) | (6.8) | (7.0) | 7.6 | 7.4 | (8.0) | 7.8 | 6.8 | 7.0 |    |    |    |    | 15.54 | 6.66 |       | 22.2 2     |

**R2 Bronze Medal Match 2 Tatami 5 09:40**

| Competitors                                   | Kata              | 1T    | 1A    | 2T    | 2A    | 3T  | 3A  | 4T  | 4A  | 5T  | 5A    | 6T | 6A | 7T | 7A | TEC   | ATH  | Extra | Total Rank |
|---|-------------------|-------|-------|-------|-------|-----|-----|-----|-----|-----|-------|----|----|----|----|-------|------|-------|------------|
| 1 CROATIA (BRAVARIC_CILO, KEKO, PARLOV) (CRO) | 021 GOJUSHIHO SHO | (8.0) | 8.0   | (7.4) | (7.2) | 7.8 | 7.8 | 7.8 | 7.6 | 8.0 | (8.2) |    |    |    |    | 16.52 | 7.02 |       | 23.542     |
| 2 SERBIA (BOSKOV, NIKOLIC, PAVLOVIC) (SRB)    | 099 UNSU          | (8.4) | (8.4) | (7.6) | (7.4) | 7.6 | 7.6 | 8.2 | 8.0 | 8.2 | 8.4   |    |    |    |    | 16.8  | 7.2  |       | 24.0 1     |

**R2 Gold Medal Match Tatami 5 09:50**

| Competitors  | Kata     | 1T    | 1A    | 2T    | 2A    | 3T    | 3A    | 4T  | 4A  | 5T  | 5A  | 6T | 6A | 7T | 7A | TEC   | ATH  | Extra | Total Rank |
|--|----------|-------|-------|-------|-------|-------|-------|-----|-----|-----|-----|----|----|----|----|-------|------|-------|------------|
| 1 TURKEY (AKBABA, ASLAN, KILIC) (TUR)                            | 001 ANAN | (8.2) | (8.4) | (9.2) | (9.2) | 9.0   | 9.0   | 8.6 | 8.8 | 8.6 | 8.8 |    |    |    |    | 18.34 | 7.98 |       | 26.321     |
| 2 MACEDONIA KATA TEAM MALE (ANDRIC, SPASOVSKI, STOJANOSKI) (MKD) | 099 UNSU | (8.0) | (8.2) | 8.4   | 8.4   | (8.6) | (8.8) | 8.0 | 8.4 | 8.2 | 8.2 |    |    |    |    | 17.22 | 7.5  |       | 24.722     |

**Results**

|   |  |                        |   |                        |
|---|--|------------------------|---|------------------------|
| 1 | TURKEY<br>- KILIC YUSUF<br>- ASLAN GORKEM<br>- AKBABA ALI EFE                              | TURKEY                 |  | TURKEY                 |
| 2 | MACEDONIA KATA TEAM MALE<br>- ANDRIC HRISTIJAN<br>- SPASOVSKI DAVID<br>- STOJANOSKI ANDREJ | NORTH MACEDONIA        |  | NORTH MACEDONIA        |
| 3 | MONTENEGRO<br>- MILIC_NIKOLA<br>- JANJIC ALEKSA<br>- GERSCHWITZ AJSEL                      | MONTENEGRO             |  | MONTENEGRO             |
| 3 | SERBIA<br>- NIKOLIC DIMITRIJE<br>- PAVLOVIC STEFAN<br>- BOSKOV ALEKSANDAR                  | SERBIA                 |  | SERBIA                 |
| 5 | BOSNIA AND HERZEGOVINA<br>- LUGONIC ZEMIR<br>- MEHULJIC AMIR<br>- ROSIC RIJAD              | BOSNIA AND HERZEGOVINA |  | BOSNIA AND HERZEGOVINA |
| 5 | CROATIA<br>- BRAVARIC_CILO DAMJAN<br>- PARLOV NIKOLA<br>- KEKO LUKA                        | CROATIA                |  | CROATIA                |





**21st Balkan Karate Championships for Cadets,  
Juniors and U21 - RIJEKA 2021 - 2021-11-26**

**Kata Team female U21**

**R1 G1/1 (2) Tatami 4 10:05**

| Competitors |   | Kata     | 1 T   | 1 A   | 2 T   | 2 A   | 3 T | 3 A | 4 T | 4 A | 5 T | 5 A | 6 T | 6 A | 7 T | 7 A | TEC   | ATH  | Extra | Total | Rank |
|-------------|---|----------|-------|-------|-------|-------|-----|-----|-----|-----|-----|-----|-----|-----|-----|-----|-------|------|-------|-------|------|
| 1           | SERBIA (CRNOVCIC_, MESIC, NIKOLIC) (SRB)          | 099 UNSU | (7.2) | (7.0) | (8.2) | (8.2) | 8.0 | 7.8 | 8.2 | 8.2 | 7.2 | 7.4 |     |     |     |     | 16.38 | 7.02 |       | 23.4  | 1    |
| 2           | MONTENEGRO (CANOVIC_, DJUKANOVIC, MRAKOVIC) (MNE) | 099 UNSU | (6.2) | (6.0) | (7.8) | (7.8) | 7.6 | 7.4 | 7.8 | 7.8 | 7.0 | 6.6 |     |     |     |     | 15.68 | 6.54 |       | 22.22 | 2    |

**Results**

|   |  |            |   |            |
|---|--|------------|---|------------|
| 1 | SERBIA<br>- CRNOVCIC_ SLAVICA<br>- MESIC MINA<br>- NIKOLIC MILICA      | SERBIA     |  | SERBIA     |
| 2 | MONTENEGRO<br>- CANOVIC_ DZENA<br>- DJUKANOVIC MASA<br>- MRAKOVIC MILA | MONTENEGRO |  | MONTENEGRO |

**21st Balkan Karate Championships for Cadets,  
Juniors and U21 - RIJEKA 2021 - 2021-11-26  
Kata Team male U21**

**R1 G1/1 (1)**

| Competitors |  | Kata | 1 T | 1 A | 2 T | 2 A | 3 T | 3 A | 4 T | 4 A | 5 T | 5 A | 6 T | 6 A | 7 T | 7 A | TEC | ATH | Extra | Total | Rank |  |
|-------------|--|------|-----|-----|-----|-----|-----|-----|-----|-----|-----|-----|-----|-----|-----|-----|-----|-----|-------|-------|------|--|
| 1           | CROATIA (ECIMOVIC, KOKIC, PREMEC)<br>(CRO) |      |     |     |     |     |     |     |     |     |     |     |     |     |     |     |     |     |       |       |      |  |

**Results**

|   |   |         |   |         |
|---|---|---------|---|---------|
| 1 | CROATIA<br>- PREMEC IVOR<br>- KOKIC PATRIK<br>- ECIMOVIC MIHAEL | CROATIA |  | CROATIA |
|---|---|---------|---|---------|

# Kumite Team female U21

21st Balkan Karate Championships for Cadets, Juniors and U21 - RIJEKA 2021, RIJEKA, CRO

Tatami  
3 09:00

Pool  
1/1

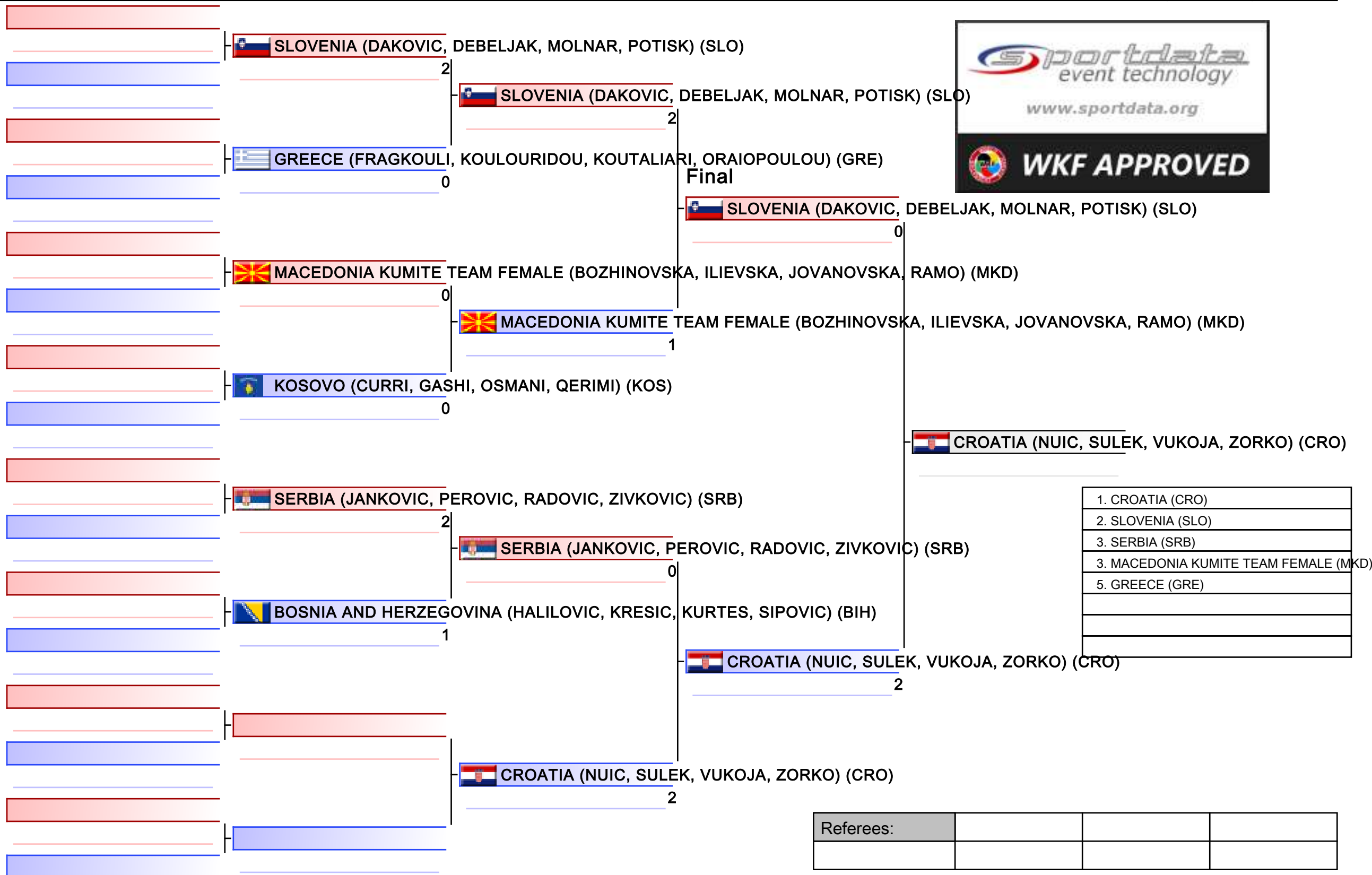

|                                       |
|---------------------------------------|
| 1. CROATIA (CRO)                      |
| 2. SLOVENIA (SLO)                     |
| 3. SERBIA (SRB)                       |
| 3. MACEDONIA KUMITE TEAM FEMALE (MKD) |
| 5. GREECE (GRE)                       |
|                                       |
|                                       |

|           |  |  |  |
|-----------|--|--|--|
| Referees: |  |  |  |
|           |  |  |  |

# Kumite Team female U21

21st Balkan Karate Championships for Cadets, Juniors and U21 - RIJEKA 2021

Tatami  
3 11:05

Pool  
1

(c)sportdata GmbH & Co KG 2000-2021(2021-11-29 16:49) -WKF Approved- v 9.8.8 build 3 (2021-11-04) License: SDIL Sportdata Internal License 2021 (expire 2021-12-31)

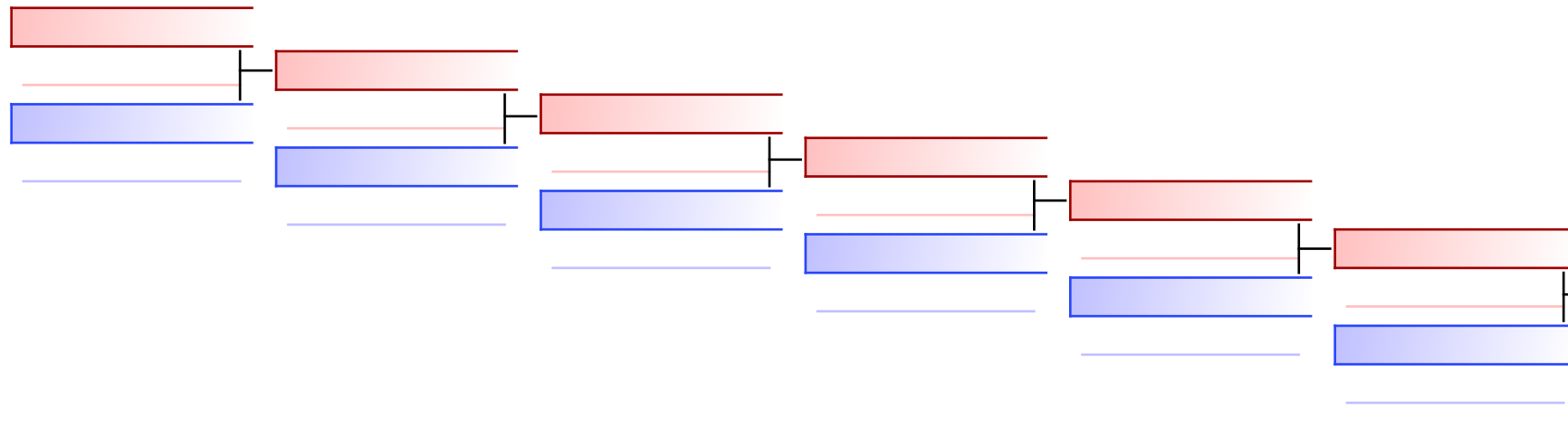

GREECE (FRAGKOULI, KOULOURIDOU, KOUTALIA)  
0  
 MACEDONIA KUMITE TEAM FE  
 MACEDONIA KUMITE TEAM FEMALE (BOZHINOVS)  
2

## REPECHAGE: (1)

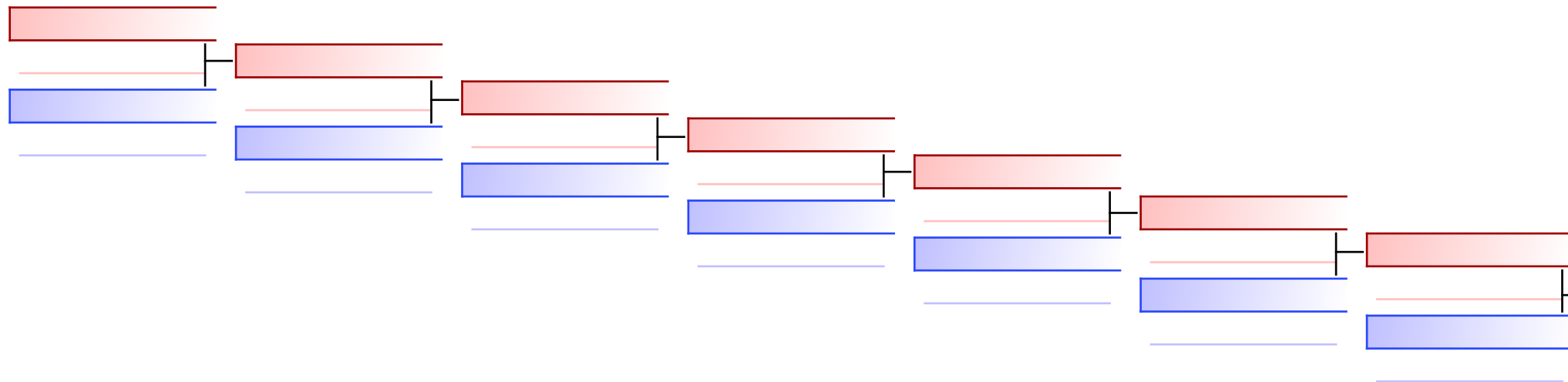

SERBIA (JANKOVIC, PEROVIC)

|           |  |  |  |  |  |  |  |
|-----------|--|--|--|--|--|--|--|
| Referees: |  |  |  |  |  |  |  |
|-----------|--|--|--|--|--|--|--|

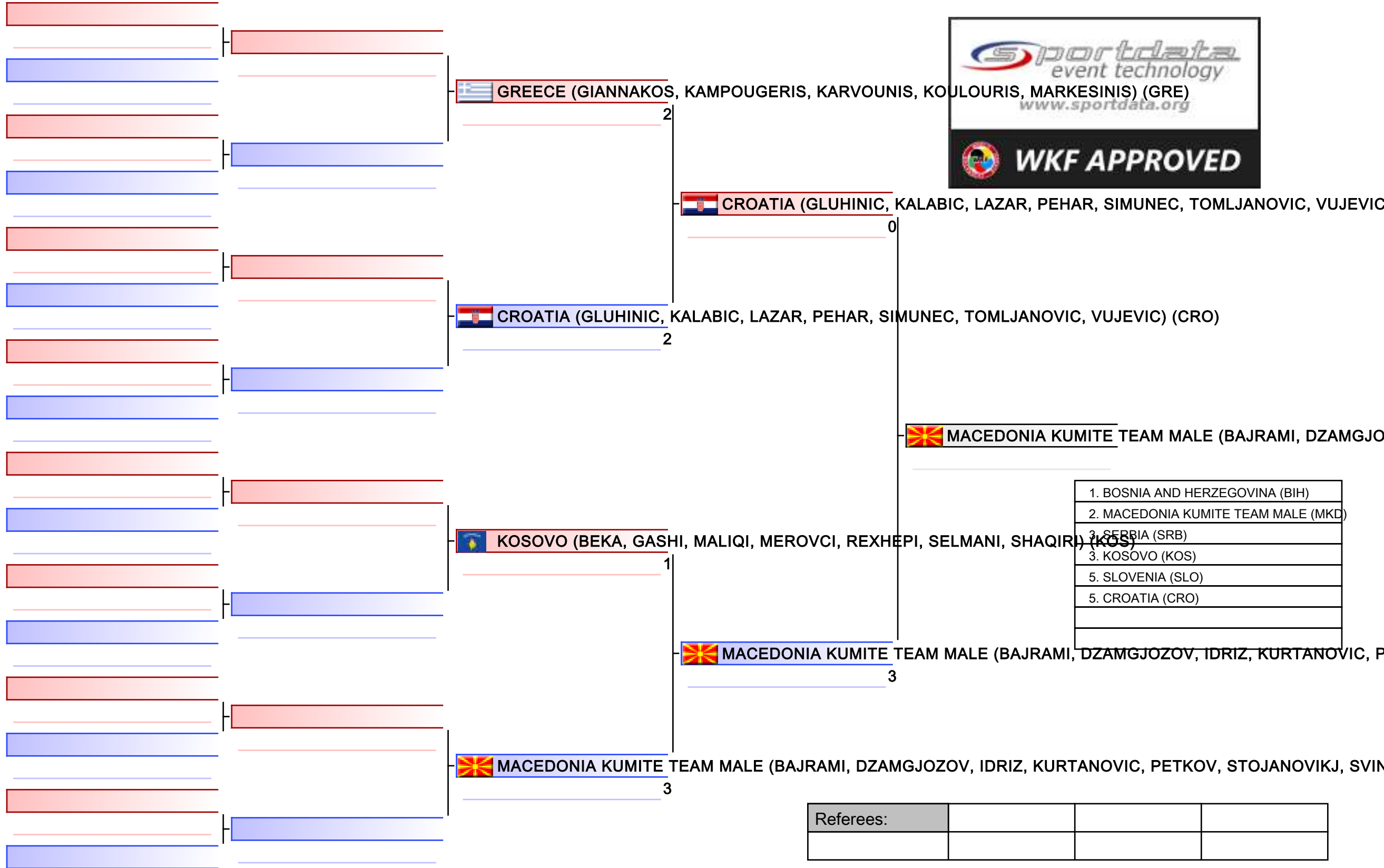

|                                     |
|-------------------------------------|
| 1. BOSNIA AND HERZEGOVINA (BIH)     |
| 2. MACEDONIA KUMITE TEAM MALE (MKD) |
| 3. SERBIA (SRB)                     |
| 3. KOSOVO (KOS)                     |
| 5. SLOVENIA (SLO)                   |
| 5. CROATIA (CRO)                    |
|                                     |
|                                     |

|           |  |  |  |
|-----------|--|--|--|
| Referees: |  |  |  |
|           |  |  |  |

# Kumite Team male U21

21st Balkan Karate Championships for Cadets, Juniors and U21 - RIJEKA 2021, RIJEKA, CRO

Tatami  
5 10:25

Pool  
2/2

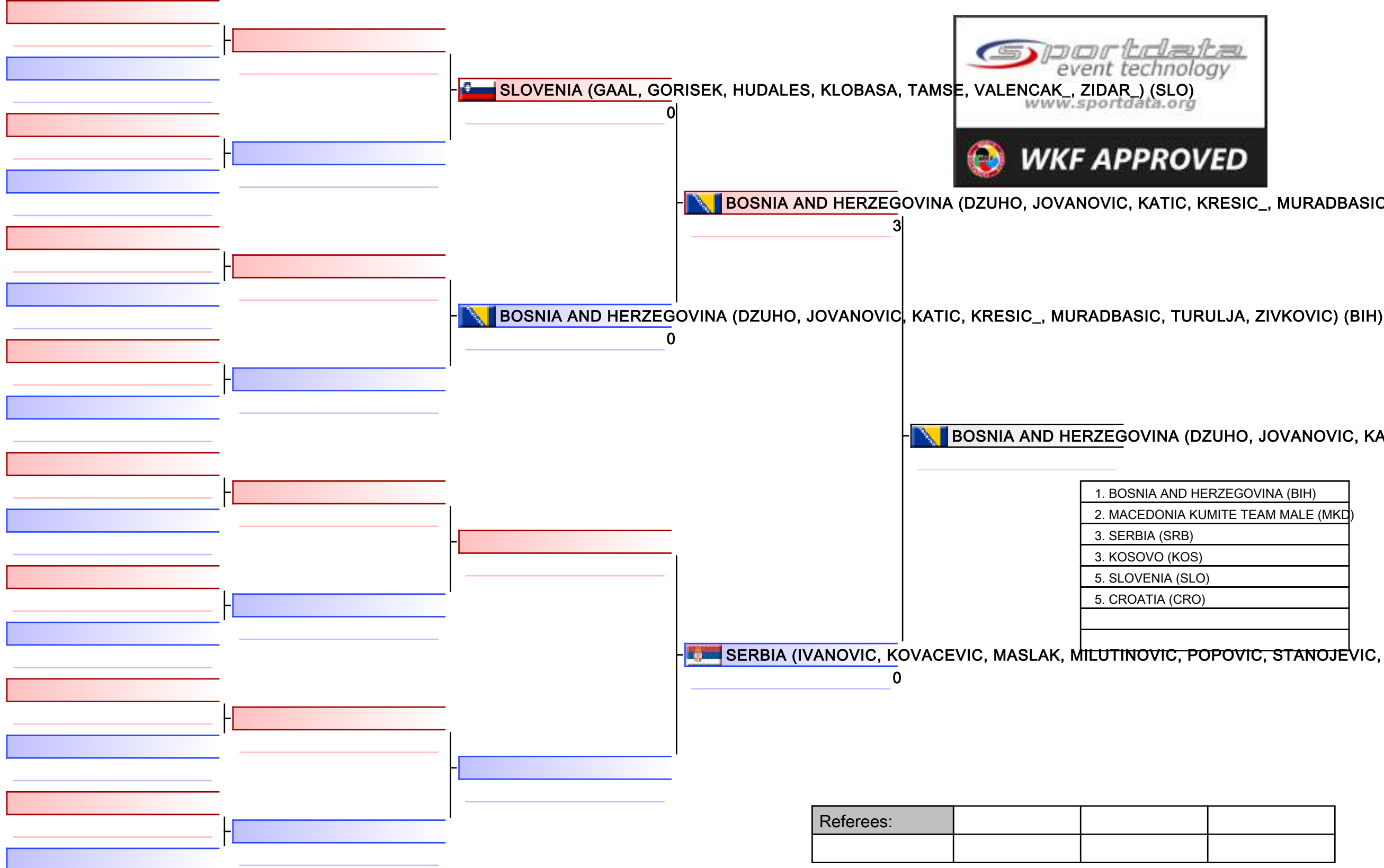

|                                     |
|-------------------------------------|
| 1. BOSNIA AND HERZEGOVINA (BIH)     |
| 2. MACEDONIA KUMITE TEAM MALE (MKD) |
| 3. SERBIA (SRB)                     |
| 3. KOSOVO (KOS)                     |
| 5. SLOVENIA (SLO)                   |
| 5. CROATIA (CRO)                    |
|                                     |
|                                     |

|           |  |  |  |
|-----------|--|--|--|
| Referees: |  |  |  |
|           |  |  |  |

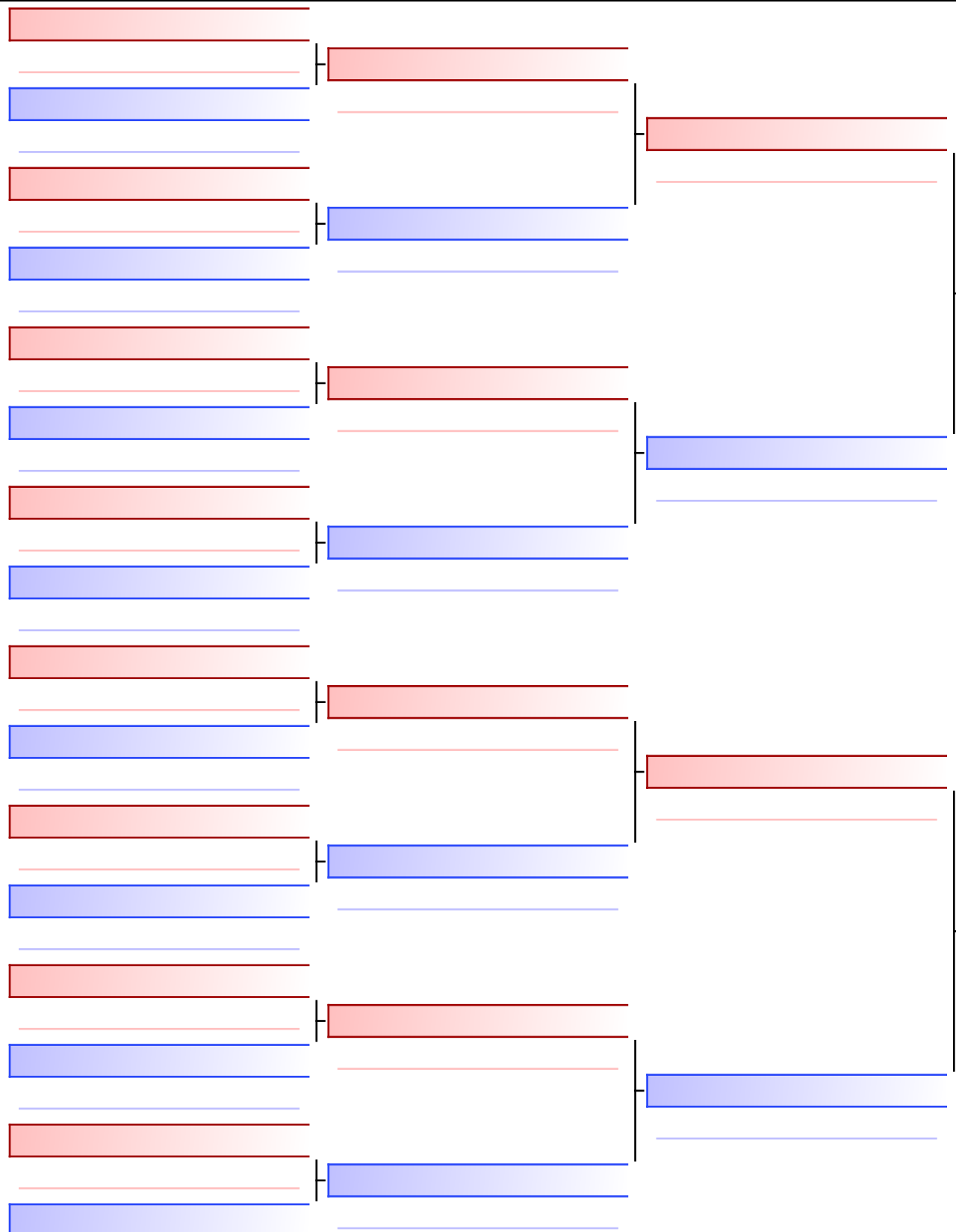

**Final**

 **MACEDONIA KUMITE TEAM MALE (BAJRAMI, DZAMGJOZOV, IDRIZ, KURTANOVIC, P**

0

 **BOSNIA AND HERZEGOVINA (DZUHO, JOVANOVIC, KAT**

 **BOSNIA AND HERZEGOVINA (DZUHO, JOVANOVIC, KATIC, KRESTIC\_, MURADBASIC,**

2

|                                     |
|-------------------------------------|
| 1. BOSNIA AND HERZEGOVINA (BIH)     |
| 2. MACEDONIA KUMITE TEAM MALE (MKD) |
| 3. SERBIA (SRB)                     |
| 3. KOSOVO (KOS)                     |
| 5. SLOVENIA (SLO)                   |
| 5. CROATIA (CRO)                    |
|                                     |
|                                     |

|           |  |  |  |
|-----------|--|--|--|
| Referees: |  |  |  |
|           |  |  |  |

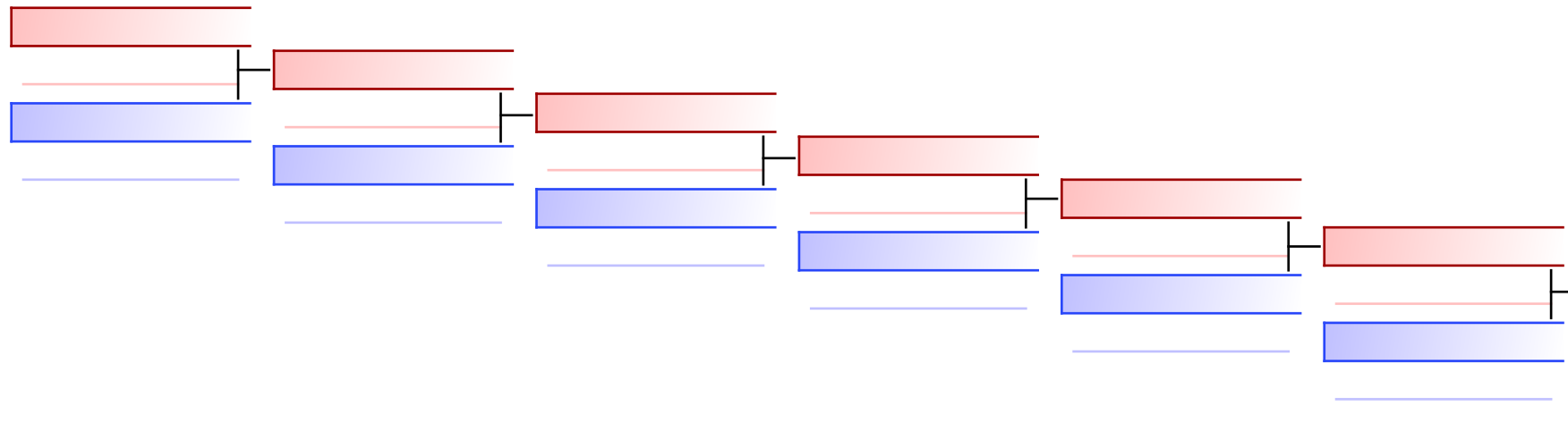

|  |  |   |  |   |
|--|--|---|--|---|
|  | KOSOVO (BEKA, GASHI, MALIQI, MEROVCI, REXH)  | 3 |  | KOSOVO (BEKA, GASHI, MALIQI, MEROVCI, REXH) |
|  | CROATIA (GLUHINIC, KALABIC, LAZAR, PEHAR, S) | 0 |  |   |

REPECHAGE: (1)

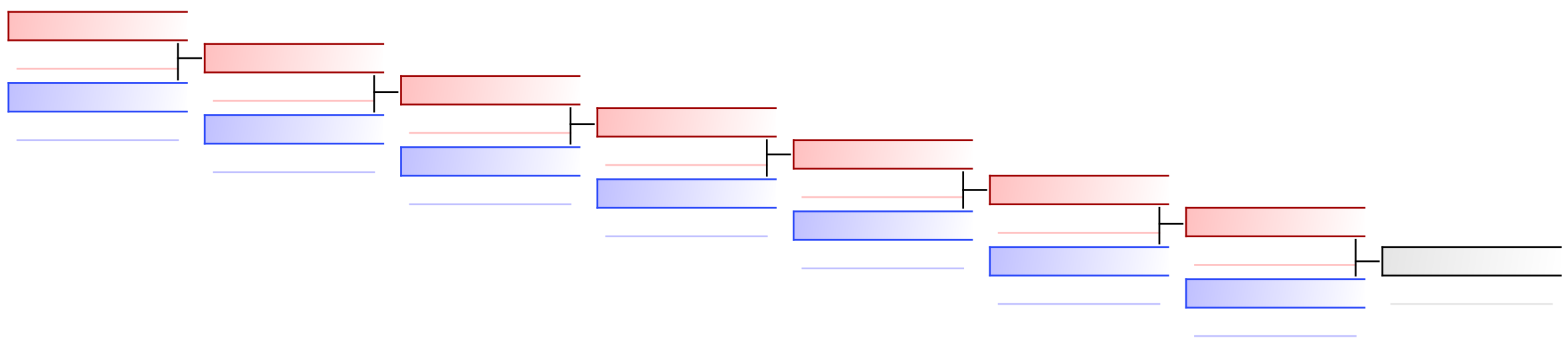

|           |  |  |  |  |  |  |  |
|-----------|--|--|--|--|--|--|--|
| Referees: |  |  |  |  |  |  |  |
|-----------|--|--|--|--|--|--|--|



# Kumite Team male U21



21st Balkan Karate Championships for Cadets, Juniors and U21 - RIJEKA 2021

Tatami  
5 11:35

Pool  
2

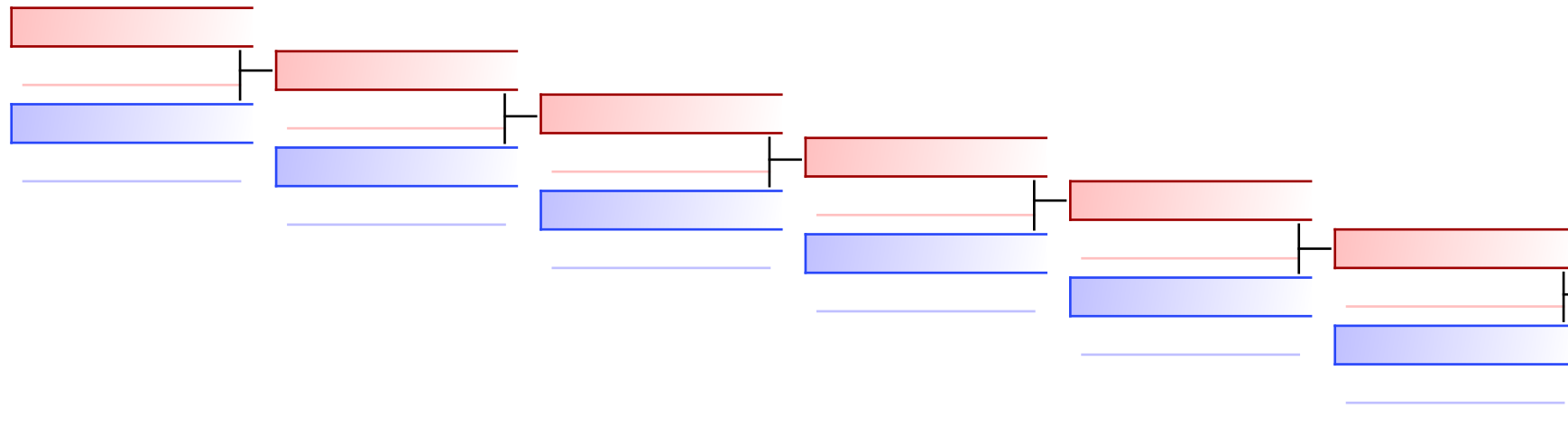
(c)sportdata GmbH & Co KG 2000-2021(2021-11-29 16:49) -WKF Approved- v 9.8.8 build 3 (2021-11-04) License: SDIL Sportdata Internal License 2021 (expire 2021-12-31)



 SLOVENIA (GAAL, GORISEK, HUDALES, KLOBASA)  
0  
 SERBIA (IVANOVIC, KOVACEVIC)  
 SERBIA (IVANOVIC, KOVACEVIC, MASLAK, MILUTINOVIC)  
3

## REPECHAGE: (2)

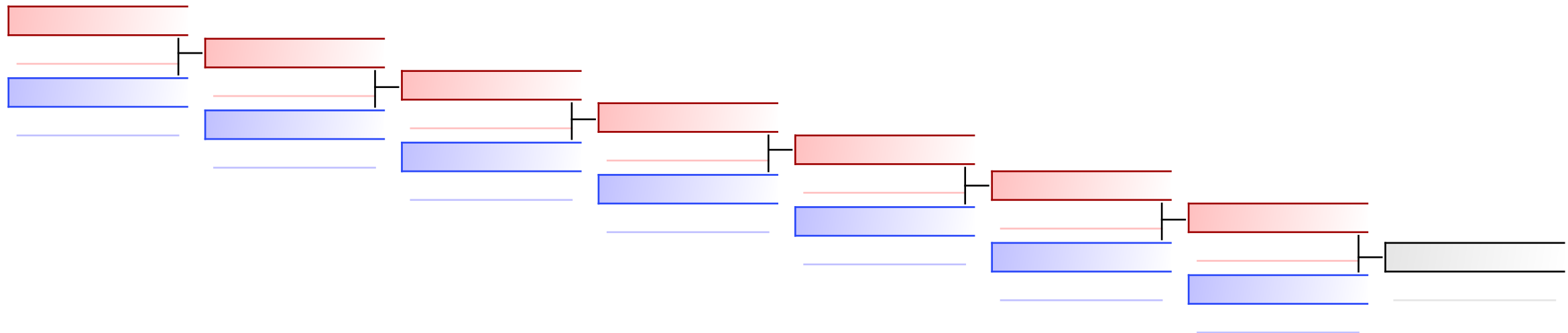

|           |  |  |  |  |  |  |  |
|-----------|--|--|--|--|--|--|--|
| Referees: |  |  |  |  |  |  |  |
|-----------|--|--|--|--|--|--|--|

**21st Balkan Karate Championships for Cadets,  
Juniors and U21 - RIJEKA 2021 - 2021-11-26**

**U21 Kata Female**

**R1 G1/2 (12) Tatami 6 09:00**

| Competitors                     | Kata          | 1T    | 1A    | 2T    | 2A    | 3T    | 3A    | 4T  | 4A  | 5T    | 5A    | 6T | 6A | 7T | 7A | TEC   | ATH  | Extra | Total Rank |    |
|---------------------------------|---------------|-------|-------|-------|-------|-------|-------|-----|-----|-------|-------|----|----|----|----|-------|------|-------|------------|----|
| 1 BUDAKOVA ANTONETA (KOS)       | KANKU SHO     | 6.8   | (6.6) | (7.4) | (7.0) | (6.4) | 6.6   | 6.4 | 7.0 | 6.4   | 6.6   |    |    |    |    | 13.72 | 6.06 |       | 19.78      | 12 |
| 2 POPESCU MARIA_ANASTASIA (ROU) | GOJUSHIHO SHO | 7.2   | (7.0) | (7.6) | 7.0   | (6.6) | (6.8) | 7.0 | 6.8 | 7.2   | 7.0   |    |    |    |    | 14.98 | 6.24 |       | 21.22      | 11 |
| 3 MOYSIDOU ANTONIA (GRE)        | 002 ANAN DAI  | (8.0) | (8.0) | 8.0   | (7.4) | (7.0) | 7.4   | 8.0 | 8.0 | 7.6   | 7.4   |    |    |    |    | 16.52 | 6.84 |       | 23.36      | 5  |
| 4 NIKOLIC MILICA (SRB)          | KANKU SHO     | 7.6   | 7.6   | (8.6) | (8.4) | (7.2) | (7.0) | 7.4 | 7.0 | 8.2   | 8.0   |    |    |    |    | 16.24 | 6.78 |       | 23.02      | 7  |
| 5 BOROVCANIN ISIDORA (BIH)      | GOJUSHIHO SHO | 7.8   | 7.8   | (8.6) | (8.8) | 7.2   | 7.4   | 7.4 | 7.0 | (6.8) | (6.6) |    |    |    |    | 15.68 | 6.66 |       | 22.34      | 9  |
| 6 MRAKOVIC MILA (MNE)           | GOJUSHIHO DAI | 7.8   | 7.6   | (8.4) | 8.0   | (7.4) | (7.4) | 7.8 | 7.6 | 8.4   | (8.2) |    |    |    |    | 16.8  | 6.96 |       | 23.76      | 3  |
| 7 OZYANCAK TUGCE_ELIF (TUR)     | GOJUSHIHO SHO | 8.0   | 7.8   | 8.2   | (8.6) | (7.0) | (7.4) | 7.6 | 8.0 | (8.8) | 8.6   |    |    |    |    | 16.66 | 7.32 |       | 23.98      | 2  |
| 8 GANZITTI NIA (SLO)            | GOJUSHIHO DAI | (8.4) | (8.2) | 7.8   | 7.8   | (7.0) | (6.8) | 7.6 | 7.6 | 8.0   | 7.8   |    |    |    |    | 16.38 | 6.96 |       | 23.34      | 6  |
| 9 MANCHEVSKA JOVANA (MKD)       | GOJUSHIHO SHO | (7.4) | (7.2) | 7.6   | 7.6   | 7.4   | 7.2   | 7.6 | 8.2 | (8.8) | 8.6   |    |    |    |    | 15.82 | 6.9  |       | 22.72      | 8  |
| 10 RAGUZ IVANA (CRO)            | GOJUSHIHO SHO | 7.8   | (7.4) | 8.0   | 8.2   | (7.6) | 7.4   | 8.0 | 7.8 | (9.2) | (9.0) |    |    |    |    | 16.66 | 7.02 |       | 23.68      | 4  |
| 11 PAVIC JELENA (SRB)           | GOJUSHIHO SHO | 7.6   | 7.4   | (8.4) | (8.2) | (7.2) | (7.0) | 7.6 | 7.0 | 7.4   | 7.2   |    |    |    |    | 15.82 | 6.48 |       | 22.3       | 10 |
| 12 TSAGKERA SOFIA (GRE)         | ANAN DAI      | 8.0   | (7.6) | 8.4   | 8.0   | (7.4) | 7.6   | 8.0 | 8.2 | (8.6) | (8.4) |    |    |    |    | 17.08 | 7.14 |       | 24.22      | 1  |

**R1 G2/2 (11) Tatami 6 10:00**

| Competitors                   | Kata              | 1T    | 1A    | 2T    | 2A    | 3T    | 3A    | 4T    | 4A    | 5T    | 5A    | 6T | 6A | 7T | 7A | TEC   | ATH  | Extra | Total Rank |    |
|-------------------------------|-------------------|-------|-------|-------|-------|-------|-------|-------|-------|-------|-------|----|----|----|----|-------|------|-------|------------|----|
| 1 JANCHOVSKA KAROLINA (MKD)   | 019 GOJUSHIHO     | 6.8   | 7.0   | (6.2) | (6.4) | (7.4) | 7.2   | 7.4   | (7.6) | 7.4   | 7.4   |    |    |    |    | 15.12 | 6.48 |       | 21.6       | 7  |
| 2 CESAR PIA (SLO)             | 020 GOJUSHIHO DAI | (8.6) | (8.2) | (6.8) | (6.6) | 7.2   | 7.0   | 7.8   | 7.6   | 7.6   | 7.8   |    |    |    |    | 15.82 | 6.72 |       | 22.54      | 4  |
| 3 MESIC MINA (SRB)            | 020 GOJUSHIHO DAI | (6.6) | (6.8) | 7.0   | 6.8   | 7.0   | 7.2   | 7.2   | (7.4) | (7.4) | 7.2   |    |    |    |    | 14.84 | 6.36 |       | 21.2       | 8  |
| 4 BEGANOVIC AMILA (BIH)       | 020 GOJUSHIHO DAI | (8.4) | (8.2) | 7.2   | (6.6) | (7.0) | 6.8   | 7.6   | 7.6   | 7.2   | 7.0   |    |    |    |    | 15.4  | 6.42 |       | 21.82      | 6  |
| 5 KOULOURIDOU PANAGIOTA (GRE) |                   |       |       |       |       |       |       |       |       |       |       |    |    |    |    |       |      |       |            |    |
| 6 CANOVIC_DZENA (MNE)         | 021 GOJUSHIHO SHO | 6.4   | 6.6   | (6.2) | (6.4) | 6.8   | 6.8   | 6.8   | 6.6   | (7.2) | (7.0) |    |    |    |    | 14.0  | 6.0  |       | 20.0       | 10 |
| 7 KELESTURA SEMINA (BIH)      | 021 GOJUSHIHO SHO | 7.0   | 6.6   | (6.6) | (6.2) | 7.0   | 7.0   | (7.2) | (7.4) | 7.0   | 7.2   |    |    |    |    | 14.7  | 6.24 |       | 20.94      | 9  |
| 8 ECIMOVIC MATEA (CRO)        | 015 GANKAKU       | (8.8) | (8.8) | (7.4) | (7.2) | 7.6   | 7.4   | 7.6   | 7.4   | 7.6   | 7.2   |    |    |    |    | 15.96 | 6.6  |       | 22.56      | 3  |
| 9 CRNOVIC_SLAVICA (SRB)       | 021 GOJUSHIHO SHO | (8.4) | (8.2) | 7.8   | 7.8   | 7.4   | (7.4) | 7.4   | 7.4   | (7.2) | 7.4   |    |    |    |    | 15.82 | 6.78 |       | 22.6       | 2  |
| 10 COLAK KEYDA_NUR (TUR)      | 068 PAPUREN       | (9.0) | (8.8) | 8.4   | 8.2   | (7.8) | (7.6) | 7.8   | 8.0   | 7.8   | 8.2   |    |    |    |    | 16.8  | 7.32 |       | 24.12      | 1  |
| 11 DJUKANOVIC MASA (MNE)      | 021 GOJUSHIHO SHO | (7.8) | (7.6) | 7.8   | 7.4   | 7.4   | 7.4   | (7.0) | (7.2) | 7.2   | 7.4   |    |    |    |    | 15.68 | 6.66 |       | 22.34      | 5  |

**R2-G1 Tatami 6 10:55**

| Competitors                 | Kata                    | 1T    | 1A    | 2T  | 2A    | 3T    | 3A    | 4T    | 4A    | 5T  | 5A  | 6T | 6A | 7T | 7A | TEC   | ATH  | Extra | Total Rank |   |
|-----------------------------|-------------------------|-------|-------|-----|-------|-------|-------|-------|-------|-----|-----|----|----|----|----|-------|------|-------|------------|---|
| 1 TSAGKERA SOFIA (GRE)      | 008 CHATANYARA KUSHANKU | 7.8   | 7.6   | 8.0 | 7.8   | (8.4) | (8.2) | (7.6) | (7.4) | 8.0 | 7.8 |    |    |    |    | 16.66 | 6.96 |       | 23.62      | 2 |
| 2 MRAKOVIC MILA (MNE)       | 021 GOJUSHIHO SHO       | (7.4) | 7.6   | 7.4 | (7.2) | (8.2) | (8.0) | 7.4   | 7.6   | 7.6 | 7.6 |    |    |    |    | 15.68 | 6.84 |       | 22.52      | 4 |
| 3 RAGUZ IVANA (CRO)         | 099 UNSU                | (8.2) | (8.0) | 7.8 | 7.6   | 8.0   | 7.8   | (7.4) | (7.2) | 7.8 | 7.8 |    |    |    |    | 16.52 | 6.96 |       | 23.48      | 3 |
| 4 OZYANCAK TUGCE_ELIF (TUR) | 015 GANKAKU             | 8.2   | 8.2   | 8.4 | 8.2   | (8.6) | (8.4) | (7.8) | (7.6) | 8.0 | 8.0 |    |    |    |    | 17.22 | 7.32 |       | 24.54      | 1 |

**R2-G2 Tatami 6 11:15**

| Competitors             | Kata              | 1T    | 1A    | 2T  | 2A    | 3T    | 3A    | 4T  | 4A    | 5T    | 5A  | 6T | 6A | 7T | 7A | TEC   | ATH  | Extra | Total Rank |   |
|-------------------------|-------------------|-------|-------|-----|-------|-------|-------|-----|-------|-------|-----|----|----|----|----|-------|------|-------|------------|---|
| 1 ECIMOVIC MATEA (CRO)  | 078 SANSAN        | 7.8   | (8.0) | 7.8 | 7.4   | (7.4) | (7.2) | 7.8 | 8.0   | (8.2) | 8.0 |    |    |    |    | 16.38 | 7.02 |       | 23.4       | 4 |
| 2 CESAR PIA (SLO)       | 099 UNSU          | (8.4) | 8.2   | 7.8 | 8.0   | (7.6) | (7.4) | 8.2 | (8.4) | 8.4   | 8.2 |    |    |    |    | 17.08 | 7.32 |       | 24.4       | 2 |
| 3 CRNOVIC_SLAVICA (SRB) | 020 GOJUSHIHO DAI | (8.6) | (8.4) | 7.6 | 7.8   | (7.4) | (7.6) | 8.2 | 8.0   | 8.6   | 8.4 |    |    |    |    | 17.08 | 7.26 |       | 24.34      | 3 |
| 4 COLAK KEYDA_NUR (TUR) | 001 ANAN          | 8.2   | 8.4   | 8.4 | (8.6) | (7.8) | (7.6) | 8.6 | 8.4   | (8.8) | 8.6 |    |    |    |    | 17.64 | 7.62 |       | 25.26      | 1 |

**R3 Bronze Medal Match 1 Tatami 6 11:35**

| Competitors             | Kata                    | 1T    | 1A    | 2T  | 2A  | 3T    | 3A  | 4T    | 4A  | 5T  | 5A    | 6T | 6A | 7T | 7A | TEC   | ATH  | Extra | Total Rank |   |
|-------------------------|-------------------------|-------|-------|-----|-----|-------|-----|-------|-----|-----|-------|----|----|----|----|-------|------|-------|------------|---|
| 1 CRNOVIC_SLAVICA (SRB) | 041 KANKU SHO           | 8.0   | (8.2) | 8.0 | 8.0 | (7.8) | 8.0 | (8.4) | 8.2 | 7.8 | (7.6) |    |    |    |    | 16.66 | 7.26 |       | 23.92      | 1 |
| 2 TSAGKERA SOFIA (GRE)  | 009 CHIBANA NO KUSHANKU | (8.6) | (8.4) | 8.2 | 8.2 | (7.6) | 7.8 | 8.0   | 7.8 | 7.6 | (7.4) |    |    |    |    | 16.66 | 7.14 |       | 23.8       | 2 |

**R3 Bronze Medal Match 2 Tatami 6 11:45**

| Competitors         | Kata              | 1T    | 1A    | 2T    | 2A    | 3T    | 3A    | 4T  | 4A  | 5T    | 5A  | 6T | 6A | 7T | 7A | TEC   | ATH  | Extra | Total Rank |   |
|---------------------|-------------------|-------|-------|-------|-------|-------|-------|-----|-----|-------|-----|----|----|----|----|-------|------|-------|------------|---|
| 1 CESAR PIA (SLO)   | 015 GANKAKU       | (8.0) | 8.2   | 8.0   | (8.0) | 8.4   | (8.4) | 8.0 | 8.0 | (8.6) | 8.4 |    |    |    |    | 17.08 | 7.38 |       | 24.46      | 2 |
| 2 RAGUZ IVANA (CRO) | 020 GOJUSHIHO DAI | 8.2   | (8.4) | (7.8) | (7.6) | (8.6) | 8.4   | 8.2 | 8.4 | 8.4   | 8.2 |    |    |    |    | 17.36 | 7.5  |       | 24.86      | 1 |

**R3 Gold Medal Match Tatami 6 11:55**

| Competitors                 | Kata                    | 1T    | 1A    | 2T    | 2A    | 3T  | 3A  | 4T    | 4A    | 5T    | 5A    | 6T | 6A | 7T | 7A | TEC   | ATH  | Extra | Total Rank |   |
|-----------------------------|-------------------------|-------|-------|-------|-------|-----|-----|-------|-------|-------|-------|----|----|----|----|-------|------|-------|------------|---|
| 1 COLAK KEYDA_NUR (TUR)     | 008 CHATANYARA KUSHANKU | (8.0) | (8.2) | (9.0) | (8.8) | 8.2 | 8.4 | 9.0   | 8.8   | 8.2   | 8.2   |    |    |    |    | 17.78 | 7.62 |       | 25.4       | 2 |
| 2 OZYANCAK TUGCE_ELIF (TUR) | 041 KANKU SHO           | 8.6   | 8.4   | 8.8   | 8.6   | 8.4 | 8.4 | (9.2) | (8.8) | (8.0) | (8.2) |    |    |    |    | 18.06 | 7.62 |       | 25.68      | 1 |

**Results**

|   |                     |        |   |        |
|---|---------------------|--------|---|--------|
| 1 | OZYANCAK TUGCE ELIF | TURKEY |  | TURKEY |
|---|---------------------|--------|---|--------|

**21st Balkan Karate Championships for Cadets,  
Juniors and U21 - RIJEKA 2021 - 2021-11-26**

**U21 Kata Female**

|   |                 |            |   |            |
|---|-----------------|------------|---|------------|
| 2 | COLAK KEYDA NUR | TURKEY     |  | TURKEY     |
| 3 | CRNOVIC SLAVICA | SERBIA     |  | SERBIA     |
| 3 | RAGUZ IVANA     | CROATIA    |  | CROATIA    |
| 5 | TSAGKERA SOFIA  | GREECE     |  | GREECE     |
| 5 | CESAR PIA       | SLOVENIA   |  | SLOVENIA   |
| 7 | MRAKOVIC MILA   | MONTENEGRO |  | MONTENEGRO |
| 7 | ECIMOVIC MATEA  | CROATIA    |  | CROATIA    |

**21st Balkan Karate Championships for Cadets,  
Juniors and U21 - RIJEKA 2021 - 2021-11-26**

**U21 Kata Male**

**R1 G1/2 (11) Tatami 6 09:35**

| Competitors                     | Kata              | 1T    | 1A    | 2T    | 2A    | 3T    | 3A  | 4T    | 4A    | 5T    | 5A    | 6T | 6A | 7T | 7A | TEC   | ATH  | Extra | Total Rank |
|---------------------------------|-------------------|-------|-------|-------|-------|-------|-----|-------|-------|-------|-------|----|----|----|----|-------|------|-------|------------|
| 1 NEDELKOVSKI ALEKSANDAR (MKD)  | 041 KANKU SHO     | (7.8) | (8.0) | 7.8   | 8.0   | 7.4   | 7.6 | (7.2) | (7.0) | 7.8   | 8.0   |    |    |    |    | 16.1  | 7.08 |       | 23.182     |
| 2 DJORDJEVIC STRAHINJA (SRB)    | 021 GOJUSHIHO SHO | 7.2   | 7.4   | (8.0) | (7.8) | 7.0   | 7.2 | (6.6) | (6.6) | 7.4   | 7.2   |    |    |    |    | 15.12 | 6.54 |       | 21.667     |
| 3 KOSCEVIC LUKA (CRO)           | 020 GOJUSHIHO DAI | 8.0   | 7.4   | (8.4) | (8.6) | 7.2   | 7.4 | (7.0) | (6.6) | 7.4   | 7.6   |    |    |    |    | 15.82 | 6.72 |       | 22.546     |
| 4 HALILOVIC OSMAN (BIH)         | 020 GOJUSHIHO DAI | 7.2   | 7.0   | (8.0) | (7.8) | (7.0) | 7.4 | 7.4   | 7.0   | 7.0   | (6.8) |    |    |    |    | 15.12 | 6.42 |       | 21.548     |
| 5 KOCAN ARIJAN (MNE)            | 099 UNSU          | (7.2) | (7.4) | 7.6   | 7.8   | 7.6   | 7.4 | (8.0) | 7.8   | 7.8   | (8.0) |    |    |    |    | 16.1  | 6.9  |       | 23.0 3     |
| 6 RASHITI LUNDRIT (KOS)         | 021 GOJUSHIHO SHO | (6.6) | 6.8   | (7.4) | (7.4) | 7.0   | 6.8 | 7.0   | (6.6) | 7.2   | 6.8   |    |    |    |    | 14.84 | 6.12 |       | 20.969     |
| 7 CHONDROGIORGOS NIKOLAOS (GRE) |                   |       |       |       |       |       |     |       |       |       |       |    |    |    |    |       |      |       |            |
| 8 KLOBASA BLAZ (SLO)            | 099 UNSU          | 7.4   | 7.4   | 7.8   | (8.2) | 7.4   | 7.4 | (6.8) | (6.8) | (8.0) | 8.2   |    |    |    |    | 15.82 | 6.9  |       | 22.725     |
| 9 MERDA ROBERT (ROU)            | 019 GOJUSHIHO     | 6.6   | 6.4   | (7.4) | (7.2) | 6.8   | 6.6 | (6.0) | (5.8) | 6.4   | 6.8   |    |    |    |    | 13.86 | 5.94 |       | 19.8 10    |
| 10 ZDESIC ALEKSANDAR (SRB)      | 015 GANKAKU       | 8.2   | 8.0   | (8.4) | (8.6) | (7.2) | 7.6 | 7.4   | (7.0) | 7.4   | 7.0   |    |    |    |    | 16.1  | 6.78 |       | 22.884     |
| 11 NIKOCEVIC KENAN (MNE)        | 041 KANKU SHO     | 8.2   | 8.4   | (8.8) | (8.8) | (7.6) | 7.8 | 7.6   | (7.6) | 8.2   | 8.0   |    |    |    |    | 16.8  | 7.26 |       | 24.061     |

**R1 G2/2 (10) Tatami 6 10:30**

| Competitors                         | Kata              | 1T    | 1A    | 2T    | 2A    | 3T    | 3A    | 4T    | 4A    | 5T    | 5A    | 6T | 6A | 7T | 7A | TEC   | ATH  | Extra | Total Rank |
|-------------------------------------|-------------------|-------|-------|-------|-------|-------|-------|-------|-------|-------|-------|----|----|----|----|-------|------|-------|------------|
| 1 ECIMOVIC MIHAEL (CRO)             | 041 KANKU SHO     | 7.6   | (7.0) | (8.0) | (7.8) | 7.4   | 7.2   | 8.0   | 7.6   | (7.2) | 7.4   |    |    |    |    | 16.1  | 6.66 |       | 22.768     |
| 2 KAYNAR OMER_BERAT (TUR)           | 021 GOJUSHIHO SHO | 8.2   | 8.0   | (8.6) | (8.4) | 8.2   | 8.2   | 8.4   | 8.2   | (7.4) | (7.6) |    |    |    |    | 17.36 | 7.32 |       | 24.681     |
| 3 SUBOTA UROS (SRB)                 | 021 GOJUSHIHO SHO | (8.6) | 8.2   | 8.4   | (8.6) | (7.6) | (7.4) | 8.2   | 8.6   | 7.6   | 7.6   |    |    |    |    | 16.94 | 7.32 |       | 24.264     |
| 4 SALKANOVIC OSMAN (BIH)            | 020 GOJUSHIHO DAI | 7.2   | (6.8) | (7.8) | (7.4) | 7.2   | 7.2   | 7.6   | 7.4   | (7.0) | 6.8   |    |    |    |    | 15.4  | 6.42 |       | 21.8210    |
| 5 MARKESINIS LAMPRINOS_MARIOS (GRE) | 021 GOJUSHIHO SHO | 7.4   | 7.6   | (8.0) | 7.8   | 7.4   | 7.6   | 8.0   | (8.0) | (7.2) | (7.4) |    |    |    |    | 15.96 | 6.9  |       | 22.867     |
| 6 VELADZIC SENAID (BIH)             | 021 GOJUSHIHO SHO | 8.0   | 7.8   | 7.6   | (7.4) | 7.6   | 7.6   | (8.4) | (8.0) | (7.4) | 7.4   |    |    |    |    | 16.24 | 6.84 |       | 23.086     |
| 7 NEDELUCU ANDREI_GABRIEL (ROU)     | 002 ANAN DAI      | (7.2) | (7.4) | (8.4) | (8.6) | 8.0   | 7.8   | 8.4   | 8.6   | 7.6   | 7.8   |    |    |    |    | 16.8  | 7.26 |       | 24.065     |
| 8 STERNISA NEJC (SLO)               | 099 UNSU          | (8.4) | (8.6) | 8.2   | 8.0   | 8.0   | 8.0   | 8.2   | 8.4   | (7.6) | (7.6) |    |    |    |    | 17.08 | 7.32 |       | 24.4 2     |
| 9 BAKIC FILIP (MNE)                 | 021 GOJUSHIHO SHO | 8.4   | 8.4   | (8.6) | 8.2   | 7.8   | 7.8   | 8.2   | (8.6) | (7.6) | (7.4) |    |    |    |    | 17.08 | 7.32 |       | 24.4 3     |
| 10 RISTIC DIMITRIJE (SRB)           | 021 GOJUSHIHO SHO | (7.0) | 7.2   | (7.6) | (7.4) | 7.2   | (7.0) | 7.6   | 7.4   | 7.2   | 7.0   |    |    |    |    | 15.4  | 6.48 |       | 21.889     |

**R2-G1 Tatami 6 11:20**

| Competitors                    | Kata              | 1T    | 1A    | 2T    | 2A    | 3T    | 3A  | 4T    | 4A  | 5T    | 5A    | 6T | 6A | 7T | 7A | TEC   | ATH  | Extra | Total Rank |
|--------------------------------|-------------------|-------|-------|-------|-------|-------|-----|-------|-----|-------|-------|----|----|----|----|-------|------|-------|------------|
| 1 NIKOCEVIC KENAN (MNE)        | 099 UNSU          | (8.0) | (8.0) | (8.6) | (8.6) | 8.6   | 8.6 | 8.2   | 8.2 | 8.0   | 8.0   |    |    |    |    | 17.5  | 7.44 |       | 24.941     |
| 2 NEDELKOVSKI ALEKSANDAR (MKD) | 020 GOJUSHIHO DAI | 8.4   | 8.4   | 8.4   | (8.6) | (8.8) | 8.6 | 8.0   | 8.0 | (7.8) | (7.6) |    |    |    |    | 17.36 | 7.5  |       | 24.862     |
| 3 ZDESIC ALEKSANDAR (SRB)      | 041 KANKU SHO     | 8.2   | (8.2) | 7.8   | 8.0   | (8.4) | 8.2 | (7.6) | 7.8 | 7.6   | (7.4) |    |    |    |    | 16.52 | 7.2  |       | 23.724     |
| 4 KOCAN ARIJAN (MNE)           | 041 KANKU SHO     | 7.8   | (7.8) | (8.2) | (8.2) | 8.0   | 8.2 | 7.8   | 8.0 | (7.6) | 7.8   |    |    |    |    | 16.52 | 7.2  |       | 23.723     |

**R2-G2 Tatami 6 11:40**

| Competitors               | Kata              | 1T    | 1A    | 2T    | 2A  | 3T    | 3A    | 4T    | 4A    | 5T  | 5A  | 6T | 6A | 7T | 7A | TEC   | ATH  | Extra | Total Rank |
|---------------------------|-------------------|-------|-------|-------|-----|-------|-------|-------|-------|-----|-----|----|----|----|----|-------|------|-------|------------|
| 1 KAYNAR OMER_BERAT (TUR) | 020 GOJUSHIHO DAI | (8.4) | (8.0) | 8.0   | 7.8 | 8.0   | 7.8   | (7.6) | (7.6) | 7.6 | 7.8 |    |    |    |    | 16.52 | 7.02 |       | 23.544     |
| 2 STERNISA NEJC (SLO)     | 041 KANKU SHO     | 8.0   | (7.8) | (7.8) | 8.2 | (8.6) | (8.4) | 7.8   | 8.0   | 8.2 | 8.2 |    |    |    |    | 16.8  | 7.32 |       | 24.123     |
| 3 SUBOTA UROS (SRB)       | 020 GOJUSHIHO DAI | 8.6   | 8.6   | 8.4   | 8.6 | (9.0) | (8.8) | (8.0) | (8.2) | 8.4 | 8.4 |    |    |    |    | 17.78 | 7.68 |       | 25.462     |
| 4 BAKIC FILIP (MNE)       | 020 GOJUSHIHO DAI | 8.8   | 8.8   | (8.2) | 8.4 | (9.2) | (9.4) | 8.2   | (8.2) | 8.6 | 8.8 |    |    |    |    | 17.92 | 7.8  |       | 25.721     |

**R3 Bronze Medal Match 1 Tatami 6 12:00**

| Competitors                    | Kata              | 1T    | 1A    | 2T  | 2A    | 3T    | 3A    | 4T    | 4A  | 5T  | 5A  | 6T | 6A | 7T | 7A | TEC  | ATH  | Extra | Total Rank |
|--------------------------------|-------------------|-------|-------|-----|-------|-------|-------|-------|-----|-----|-----|----|----|----|----|------|------|-------|------------|
| 1 NEDELKOVSKI ALEKSANDAR (MKD) | 021 GOJUSHIHO SHO | (8.4) | (8.6) | 8.4 | (8.2) | 8.4   | 8.6   | (8.2) | 8.4 | 8.2 | 8.2 |    |    |    |    | 17.5 | 7.56 |       | 25.061     |
| 2 STERNISA NEJC (SLO)          | 078 SANSAI        | 8.0   | (8.2) | 8.6 | 8.2   | (8.8) | (8.4) | (7.8) | 8.2 | 8.4 | 8.2 |    |    |    |    | 17.5 | 7.38 |       | 24.882     |

**R3 Bronze Medal Match 2 Tatami 6 12:10**

| Competitors          | Kata              | 1T    | 1A  | 2T    | 2A    | 3T  | 3A  | 4T  | 4A    | 5T  | 5A  | 6T | 6A | 7T | 7A | TEC   | ATH  | Extra | Total Rank |
|----------------------|-------------------|-------|-----|-------|-------|-----|-----|-----|-------|-----|-----|----|----|----|----|-------|------|-------|------------|
| 1 KOCAN ARIJAN (MNE) | 021 GOJUSHIHO SHO | (8.4) | 8.2 | (7.8) | (7.8) | 8.0 | 8.2 | 8.4 | (8.6) | 8.2 | 8.2 |    |    |    |    | 17.22 | 7.38 |       | 24.6 2     |
| 2 SUBOTA UROS (SRB)  | 041 KANKU SHO     | (8.8) | 8.6 | (8.2) | (8.0) | 8.2 | 8.0 | 8.6 | (8.8) | 8.6 | 8.4 |    |    |    |    | 17.78 | 7.5  |       | 25.281     |

**R3 Gold Medal Match Tatami 6 12:20**

| Competitors             | Kata        | 1T    | 1A    | 2T    | 2A  | 3T  | 3A  | 4T    | 4A    | 5T  | 5A  | 6T | 6A | 7T | 7A | TEC   | ATH  | Extra | Total Rank |
|-------------------------|-------------|-------|-------|-------|-----|-----|-----|-------|-------|-----|-----|----|----|----|----|-------|------|-------|------------|
| 1 NIKOCEVIC KENAN (MNE) | 015 GANKAKU | (8.4) | (8.2) | 8.6   | 8.8 | 8.6 | 8.8 | (8.8) | (9.0) | 8.6 | 8.4 |    |    |    |    | 18.06 | 7.8  |       | 25.861     |
| 2 BAKIC FILIP (MNE)     | 099 UNSU    | (8.2) | (8.0) | (8.4) | 8.2 | 8.2 | 8.4 | 8.4   | (8.6) | 8.4 | 8.2 |    |    |    |    | 17.5  | 7.44 |       | 24.942     |

**Results**

**21st Balkan Karate Championships for Cadets,  
Juniors and U21 - RIJEKA 2021 - 2021-11-26**

**U21 Kata Male**

|   |                        |                 |   |                 |
|---|------------------------|-----------------|---|-----------------|
| 1 | NIKOCEVIC KENAN        | MONTENEGRO      |  | MONTENEGRO      |
| 2 | BAKIC FILIP            | MONTENEGRO      |  | MONTENEGRO      |
| 3 | NEDELKOVSKI ALEKSANDAR | NORTH MACEDONIA |  | NORTH MACEDONIA |
| 3 | SUBOTA UROS            | SERBIA          |  | SERBIA          |
| 5 | STERNISA NEJC          | SLOVENIA        |  | SLOVENIA        |
| 5 | KOCAN ARIJAN           | MONTENEGRO      |  | MONTENEGRO      |
| 7 | KAYNAR OMER BERAT      | TURKEY          |  | TURKEY          |



# U21 KUMITE FEMALE -50 KG

21st Balkan Karate Championships for Cadets, Juniors and U21 - RIJEKA 2021

Tatami  
6 15:40

Pool  
1

(c)sportdata GmbH & Co KG 2000-2021(2021-11-29 16:49) -WKF Approved- v 9.8.8 build 3 (2021-11-04) License: SDIL Sportdata Internal License 2021 (expire 2021-12-31)

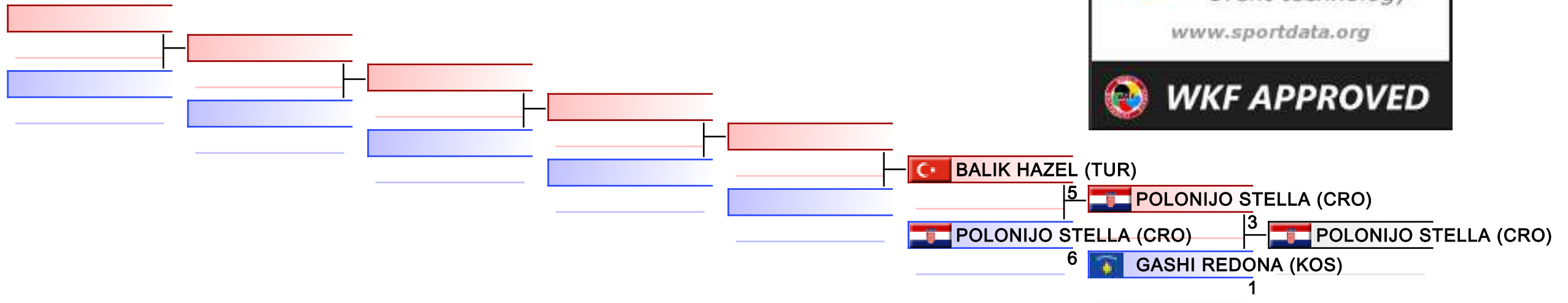

## REPECHAGE: (1)

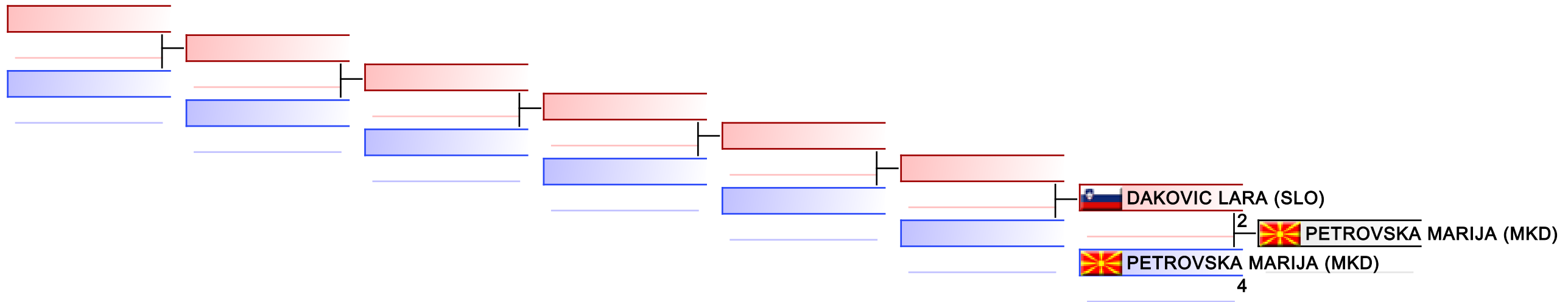

|           |  |  |  |  |  |  |  |
|-----------|--|--|--|--|--|--|--|
| Referees: |  |  |  |  |  |  |  |
|-----------|--|--|--|--|--|--|--|

# U21 KUMITE FEMALE -55 KG

21st Balkan Karate Championships for Cadets, Juniors and U21 - RIJEKA 2021, RIJEKA, CRO

Tatami  
3 09:35

Pool  
1/1

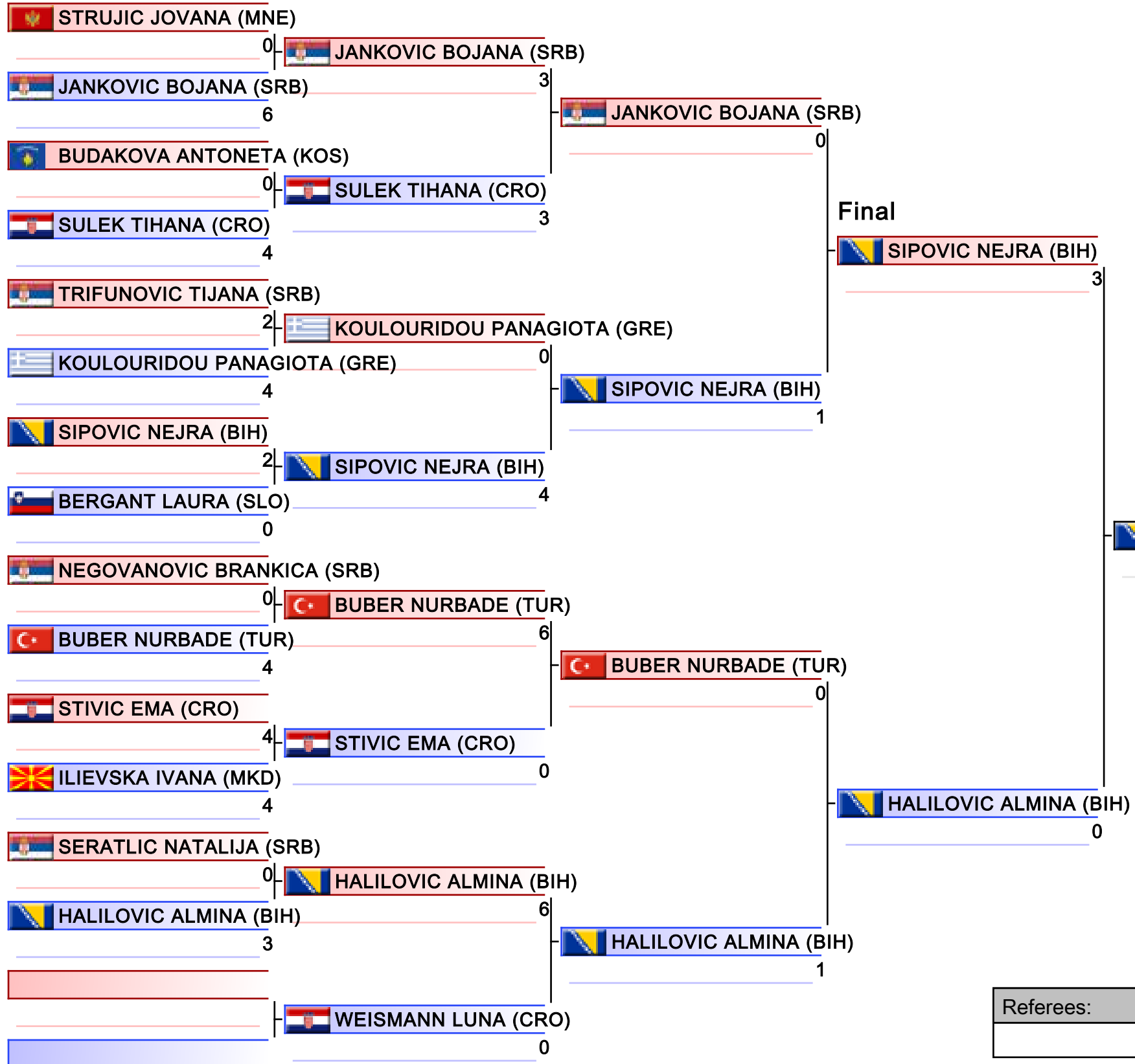

|                                |
|--------------------------------|
| 1. SIPOVIC NEJRA (BIH)         |
| 2. HALILOVIC ALMINA (BIH)      |
| 3. JANKOVIC BOJANA (SRB)       |
| 3. SERATLIC NATALIJA (SRB)     |
| 5. KOULOURIDOU PANAGIOTA (GRE) |
| 5. BUBER NURBADE (TUR)         |
| 7. BERGANT LAURA (SLO)         |
| 7. WEISMANN LUNA (CRO)         |

|           |  |  |  |
|-----------|--|--|--|
| Referees: |  |  |  |
|           |  |  |  |



# U21 KUMITE FEMALE -55 KG

21st Balkan Karate Championships for Cadets, Juniors and U21 - RIJEKA 2021

Tatami  
3 10:55

Pool  
1

(c)sportdata GmbH & Co KG 2000-2021(2021-11-29 16:49) -WKF Approved- v 9.8.8 build 3 (2021-11-04) License: SDIL Sportdata Internal License 2021 (expire 2021-12-31)

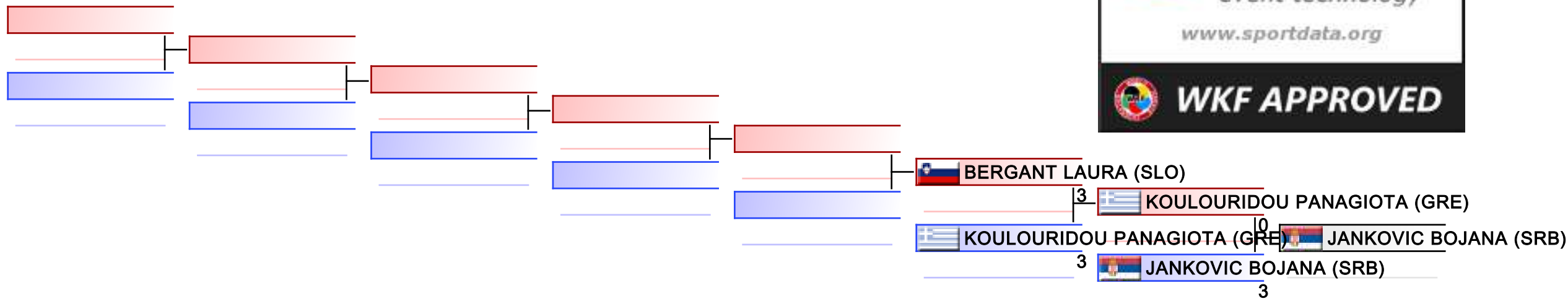

## REPECHAGE: (1)

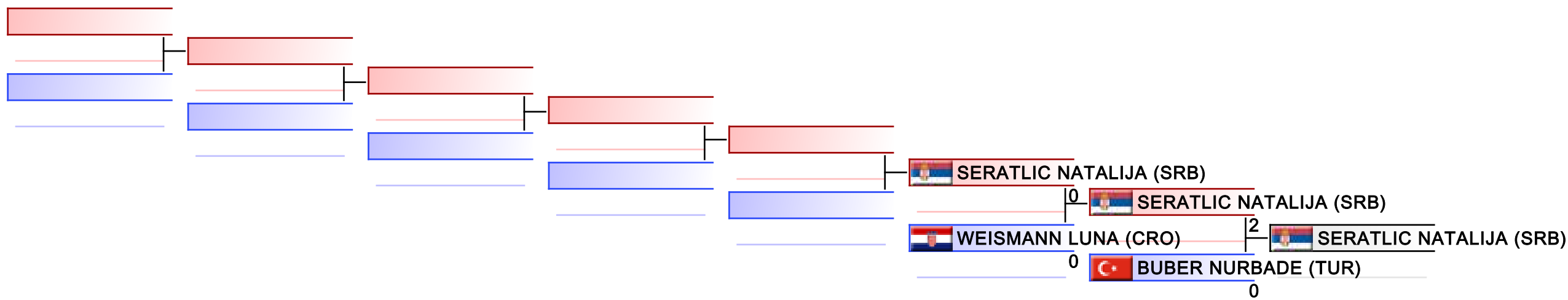

|           |  |  |  |  |  |  |  |
|-----------|--|--|--|--|--|--|--|
| Referees: |  |  |  |  |  |  |  |
|-----------|--|--|--|--|--|--|--|



# U21 KUMITE FEMALE -61 KG

21st Balkan Karate Championships for Cadets, Juniors and U21 - RIJEKA 2021

Tatami  
3 14:15

Pool  
1

(c)sportdata GmbH & Co KG 2000-2021(2021-11-29 16:49) -WKF Approved- v 9.8.8 build 3 (2021-11-04) License: SDIL Sportdata Internal License 2021 (expire 2021-12-31)

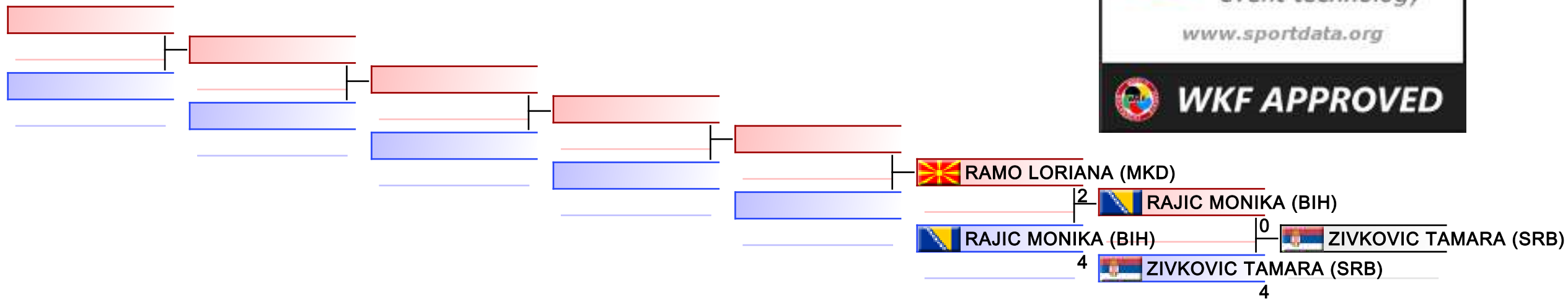

## REPECHAGE: (1)

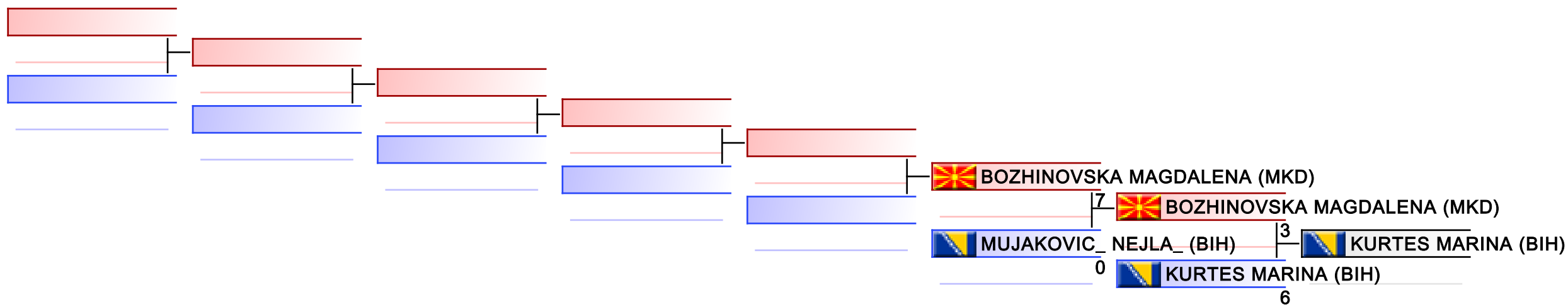

|           |  |  |  |  |  |  |  |
|-----------|--|--|--|--|--|--|--|
| Referees: |  |  |  |  |  |  |  |
|-----------|--|--|--|--|--|--|--|



# U21 KUMITE FEMALE -68 KG

21st Balkan Karate Championships for Cadets, Juniors and U21 - RIJEKA 2021

Tatami  
6 13:35

Pool  
1

(c)sportdata GmbH & Co KG 2000-2021(2021-11-29 16:49) -WKF Approved- v 9.8.8 build 3 (2021-11-04) License: SDIL Sportdata Internal License 2021 (expire 2021-12-31)

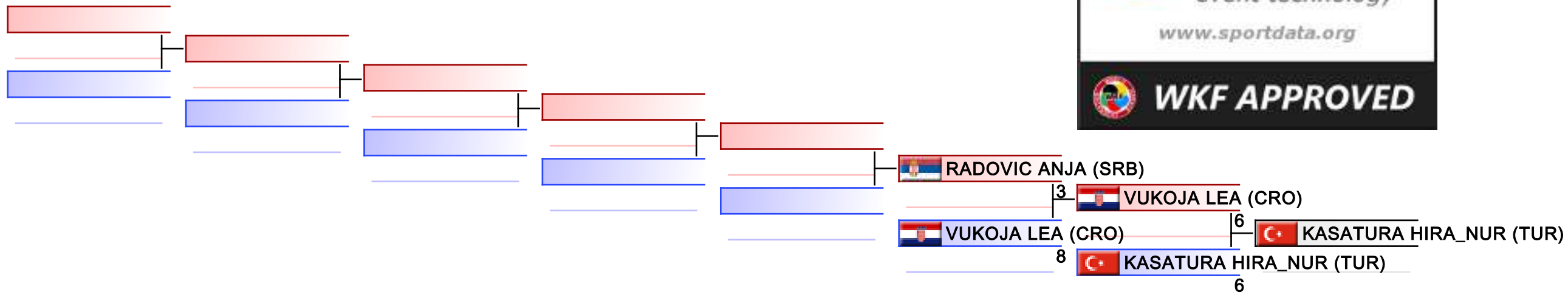

## REPECHAGE: (1)

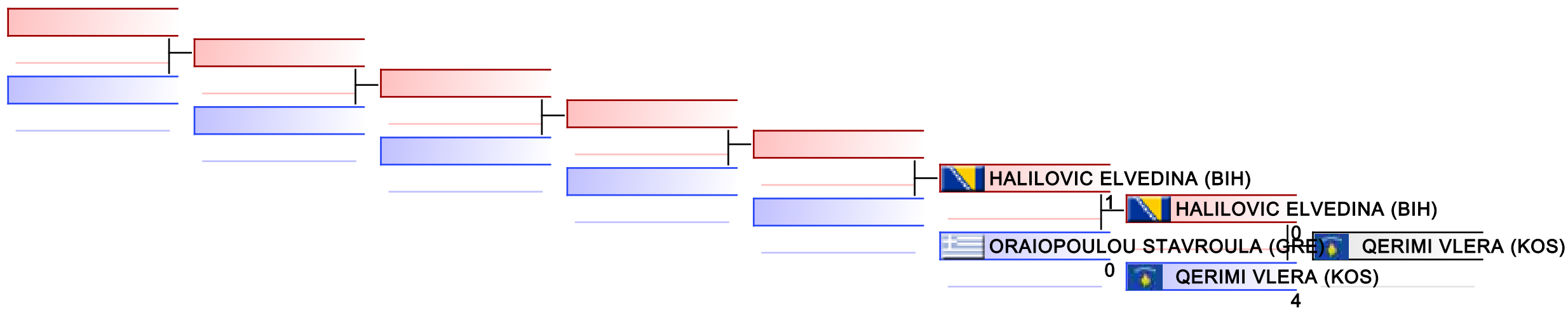

|           |  |  |  |  |  |  |  |
|-----------|--|--|--|--|--|--|--|
| Referees: |  |  |  |  |  |  |  |
|-----------|--|--|--|--|--|--|--|



# U21 KUMITE FEMALE 68+ KG

21st Balkan Karate Championships for Cadets, Juniors and U21 - RIJEKA 2021

Tatami  
4 13:10

Pool  
1

(c)sportdata GmbH & Co KG 2000-2021(2021-11-29 16:49) -WKF Approved- v 9.8.8 build 3 (2021-11-04) License: SDIL Sportdata Internal License 2021 (expire 2021-12-31)

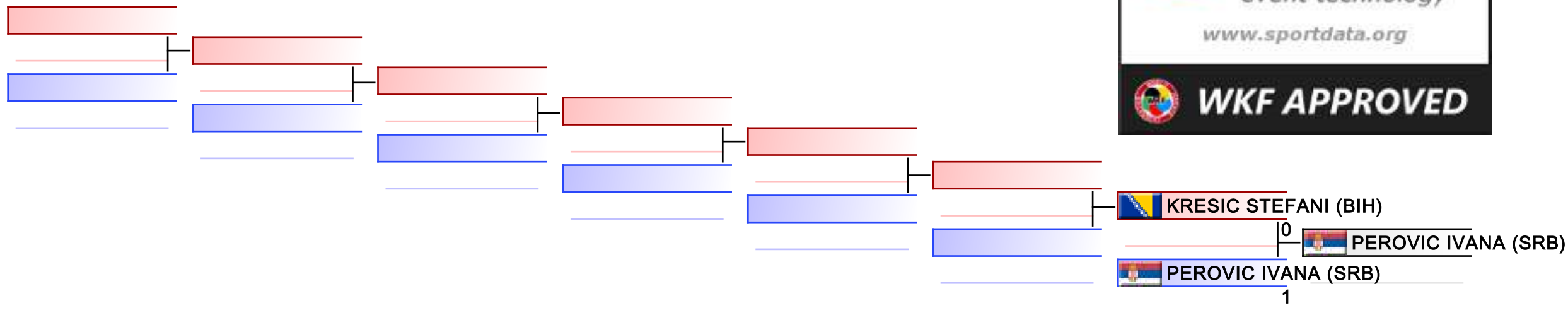

## REPECHAGE: (1)

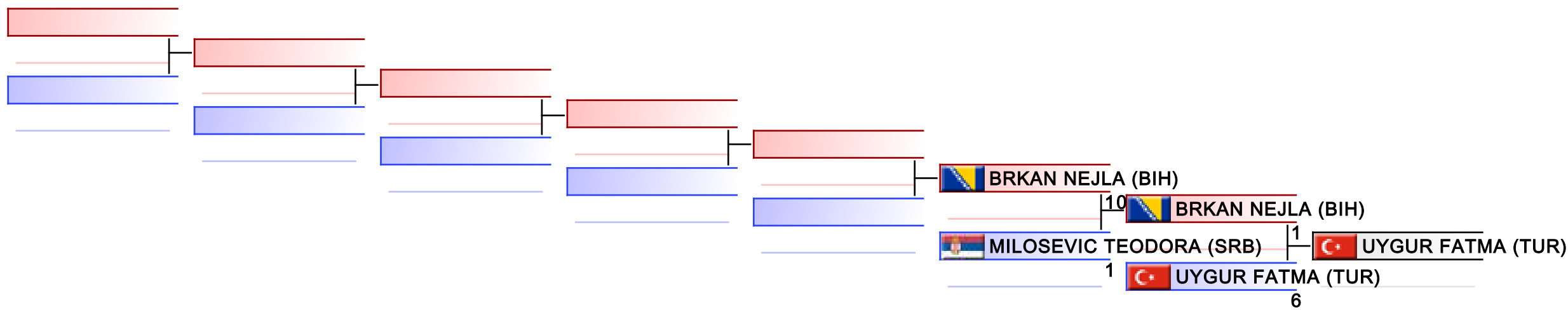

|           |  |  |  |  |  |  |  |
|-----------|--|--|--|--|--|--|--|
| Referees: |  |  |  |  |  |  |  |
|-----------|--|--|--|--|--|--|--|

# U21 KUMITE MALE -60 KG

21st Balkan Karate Championships for Cadets, Juniors and U21 - RIJEKA 2021, RIJEKA, CRO

Tatami  
6 14:10

Pool  
1/1

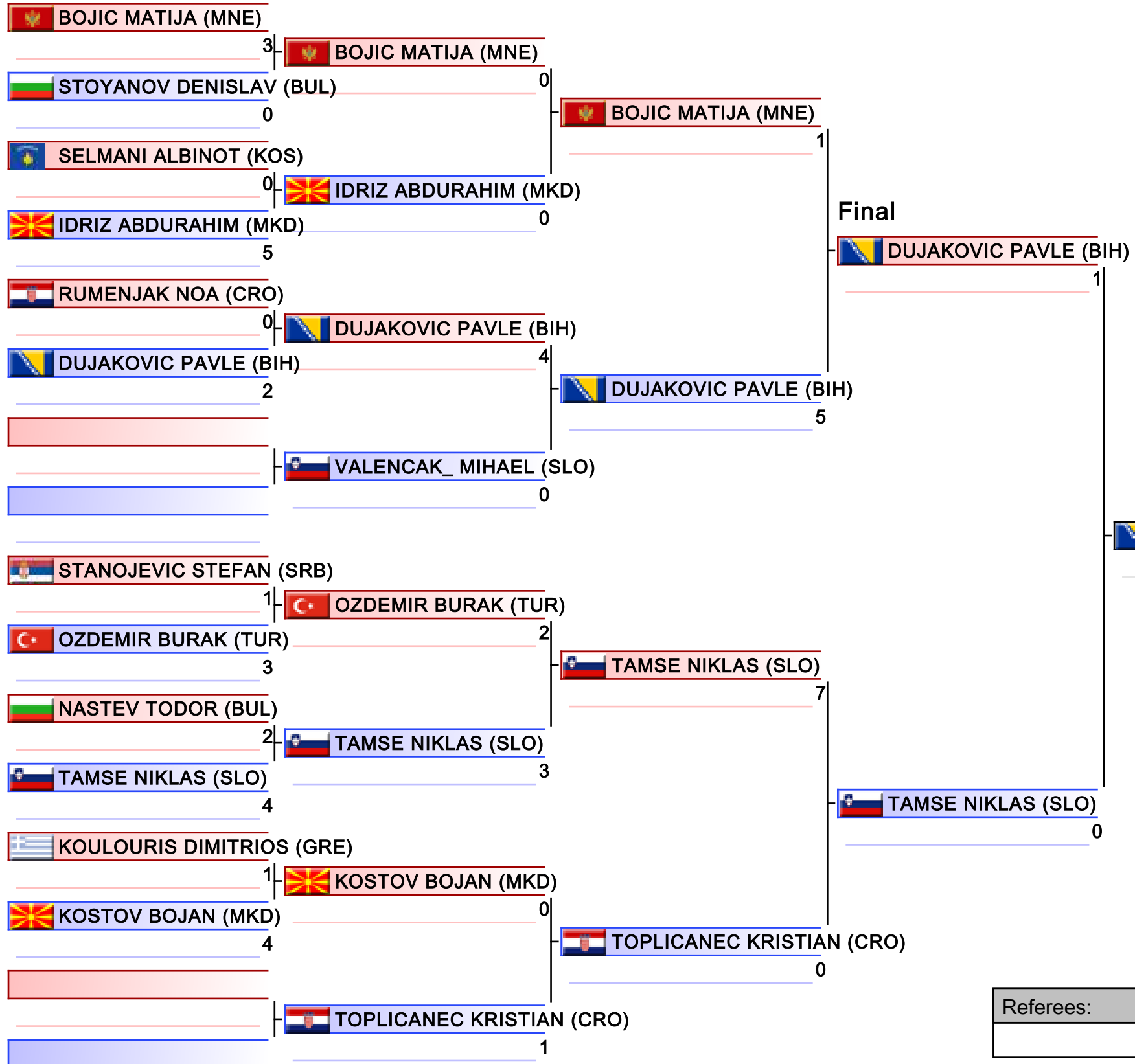

|                              |
|------------------------------|
| 1. DUJAKOVIC PAVLE (BIH)     |
| 2. TAMSE NIKLAS (SLO)        |
| 3. BOJIC MATIJA (MNE)        |
| 3. NASTEV TODOR (BUL)        |
| 5. RUMENJAK NOA (CRO)        |
| 5. TOPLICANEC KRISTIAN (CRO) |
| 7. VALENCAK_MIHAEL (SLO)     |
| 7. OZDEMIR BURAK (TUR)       |

|           |  |  |  |
|-----------|--|--|--|
| Referees: |  |  |  |
|           |  |  |  |



# U21 KUMITE MALE -60 KG

21st Balkan Karate Championships for Cadets, Juniors and U21 - RIJEKA 2021

Tatami  
6 15:25

Pool  
1

(c)sportdata GmbH & Co KG 2000-2021(2021-11-29 16:49) -WKF Approved- v 9.8.8 build 3 (2021-11-04) License: SDIL Sportdata Internal License 2021 (expire 2021-12-31)

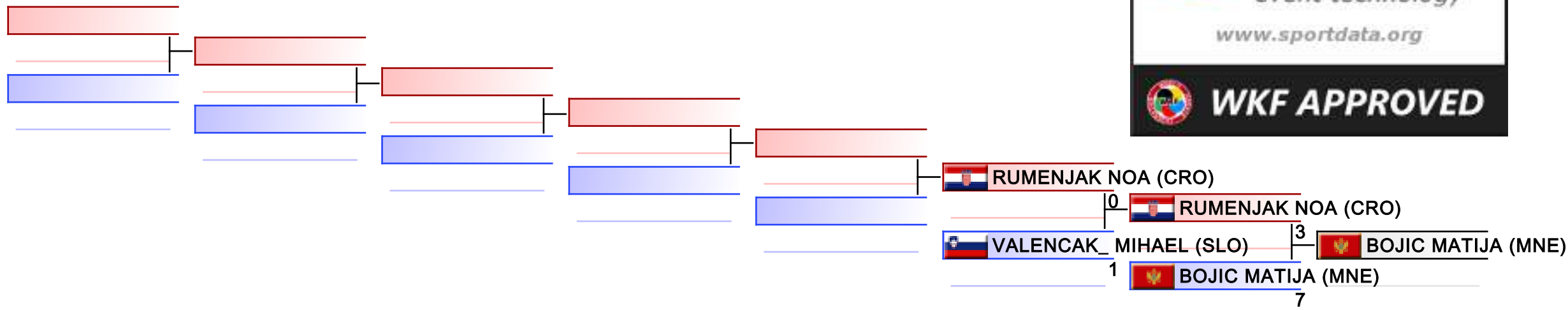

## REPECHAGE: (1)

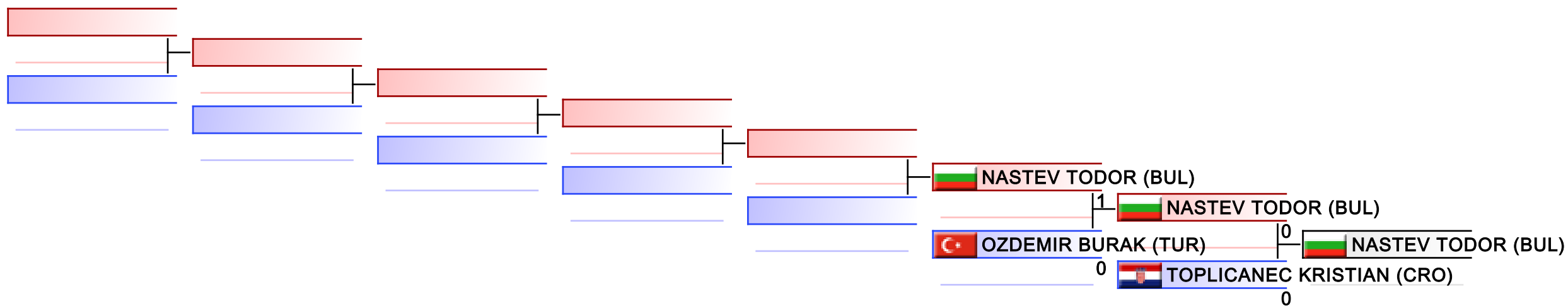

|           |  |  |  |  |  |  |  |
|-----------|--|--|--|--|--|--|--|
| Referees: |  |  |  |  |  |  |  |
|-----------|--|--|--|--|--|--|--|

# U21 KUMITE MALE -67 KG

21st Balkan Karate Championships for Cadets, Juniors and U21 - RIJEKA 2021, RIJEKA, CRO

Tatami  
4 13:45

Pool  
1/1

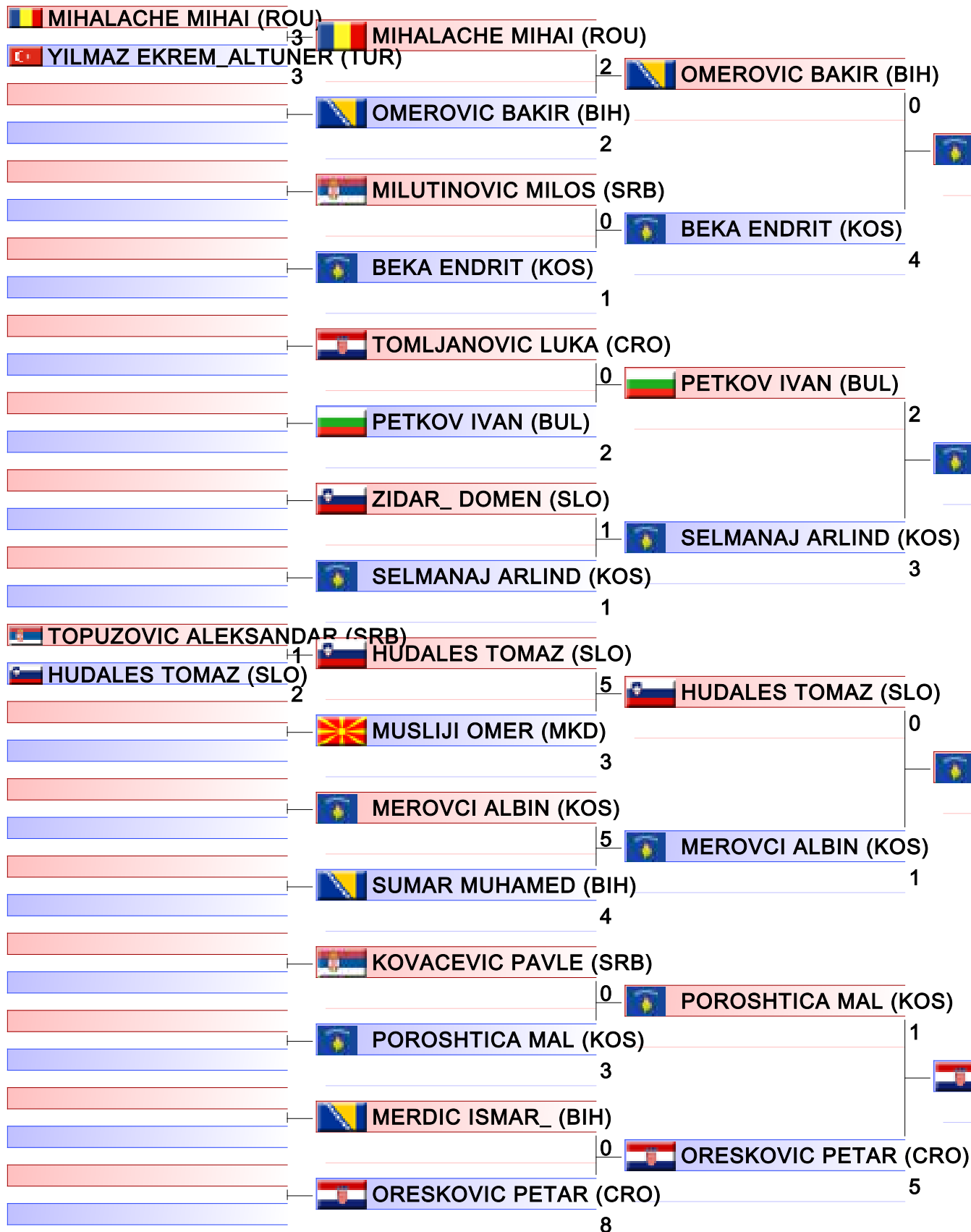

|                            |
|----------------------------|
| 1. BEKA ENDRIT (KOS)       |
| 2. MEROVCI ALBIN (KOS)     |
| 3. SELMANAJ ARLIND (KOS)   |
| 3. HUDALES TOMAZ (SLO)     |
| 5. MILUTINOVIC MILOS (SRB) |
| 5. ORESKOVIC PETAR (CRO)   |
| 7. OMEROVIC BAKIR (BIH)    |
| 7. SUMAR MUHAMED (BIH)     |

|           |  |  |  |
|-----------|--|--|--|
| Referees: |  |  |  |
|           |  |  |  |

# U21 KUMITE MALE -67 KG

21st Balkan Karate Championships for Cadets, Juniors and U21 - RIJEKA 2021

Tatami  
4 15:20

Pool  
1

(c)sportdata GmbH & Co KG 2000-2021(2021-11-29 16:49) -WKF Approved- v 9.8.8 build 3 (2021-11-04) License: SDIL Sportdata Internal License 2021 (expire 2021-12-31)

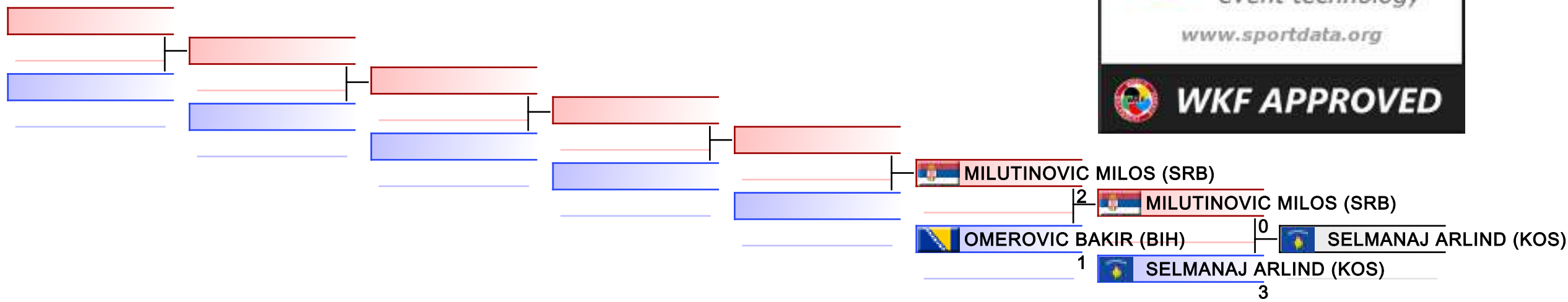

## REPECHAGE: (1)

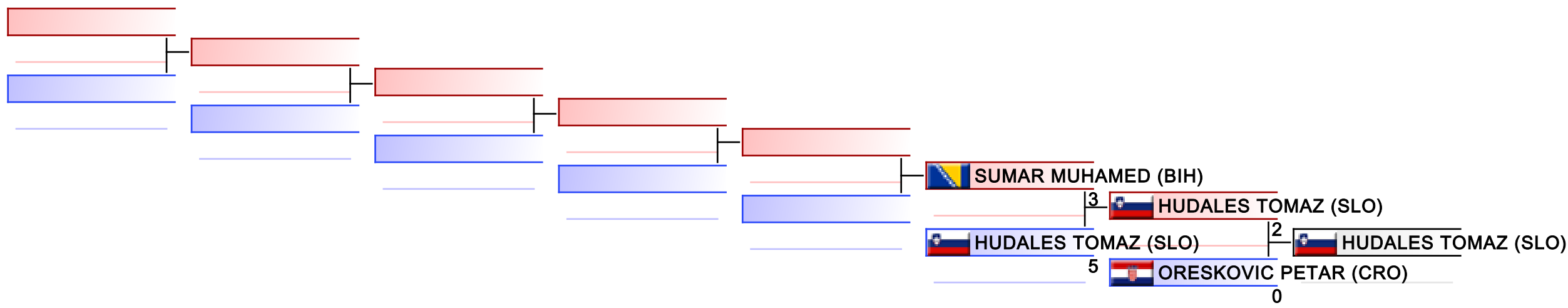

|           |  |  |  |  |  |  |  |
|-----------|--|--|--|--|--|--|--|
| Referees: |  |  |  |  |  |  |  |
|-----------|--|--|--|--|--|--|--|

# U21 KUMITE MALE -75 KG

21st Balkan Karate Championships for Cadets, Juniors and U21 - RIJEKA 2021, RIJEKA, CRO

Tatami  
3 13:45

Pool  
1/1

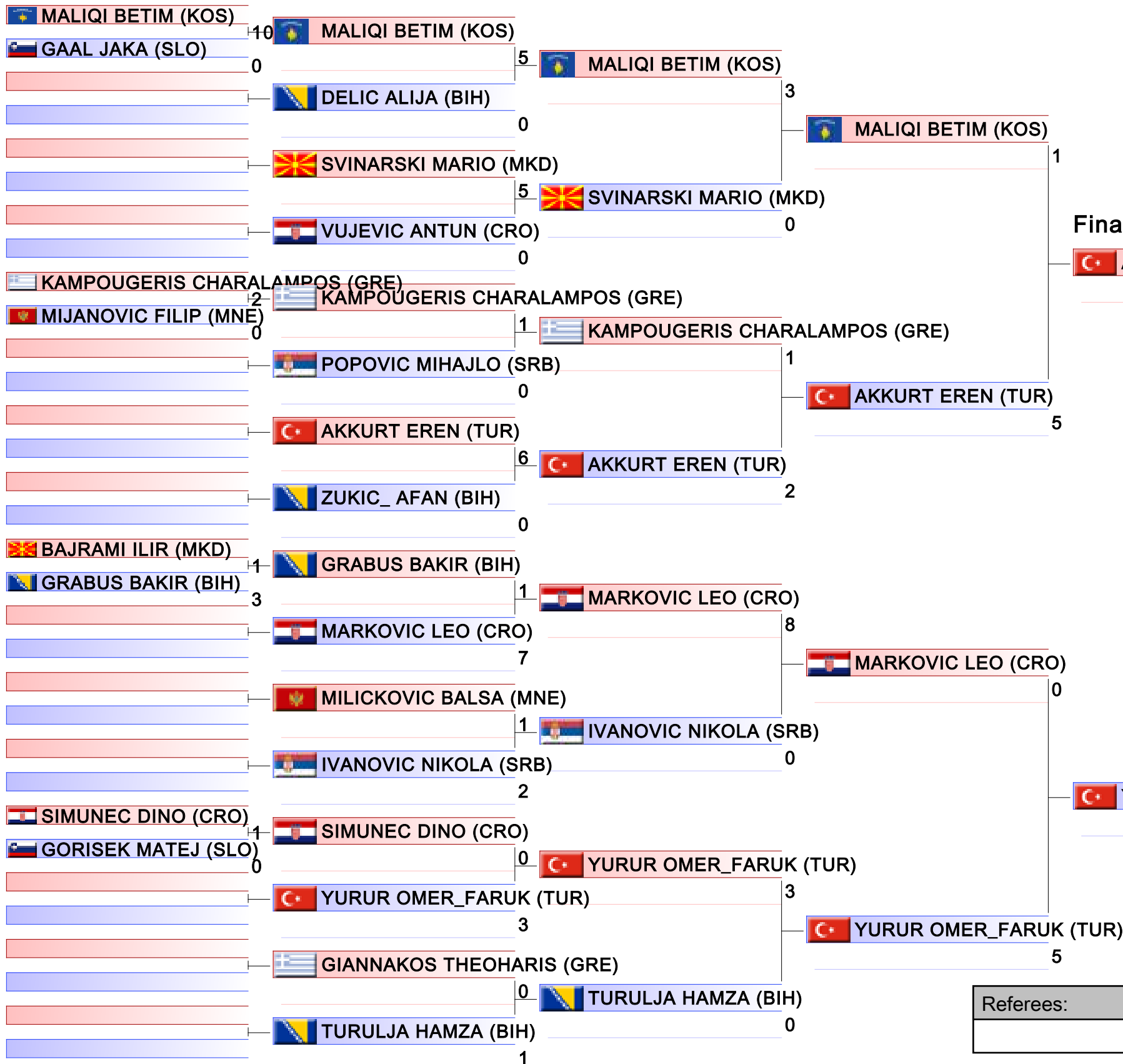

- |                                  |
|----------------------------------|
| 1. AKKURT EREN (TUR)             |
| 2. YURUR OMER_FARUK (TUR)        |
| 3. MALIQI BETIM (KOS)            |
| 3. TURULJA HAMZA (BIH)           |
| 5. ZUKIC_AFAN (BIH)              |
| 5. MARKOVIC LEO (CRO)            |
| 7. KAMPOUGERIS CHARALAMPOS (GRE) |
| 7. SIMUNEC DINO (CRO)            |

# U21 KUMITE MALE -75 KG

21st Balkan Karate Championships for Cadets, Juniors and U21 - RIJEKA 2021

Tatami  
3 15:35

Pool  
1

(c)sportdata GmbH & Co KG 2000-2021(2021-11-29 16:49) -WKF Approved- v 9.8.8 build 3 (2021-11-04) License: SDIL Sportdata Internal License 2021 (expire 2021-12-31)

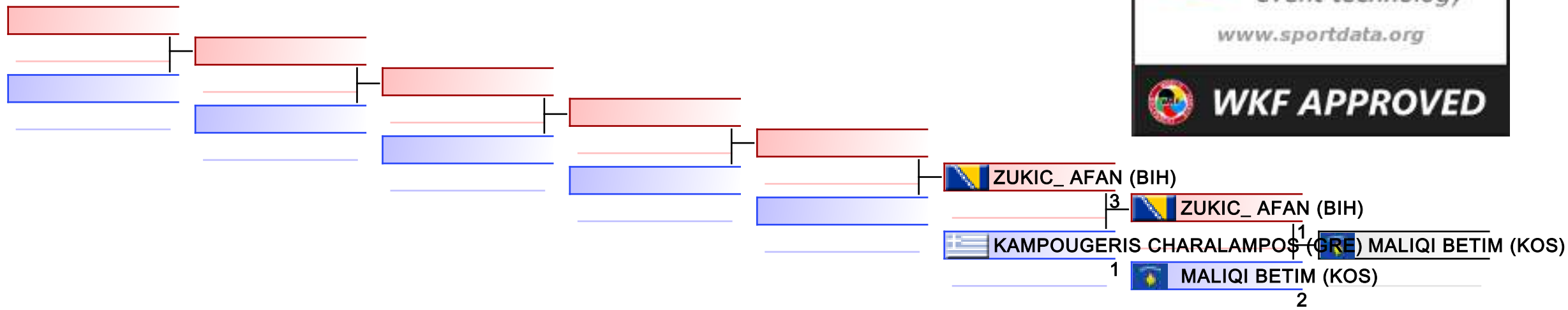

## REPECHAGE: (1)

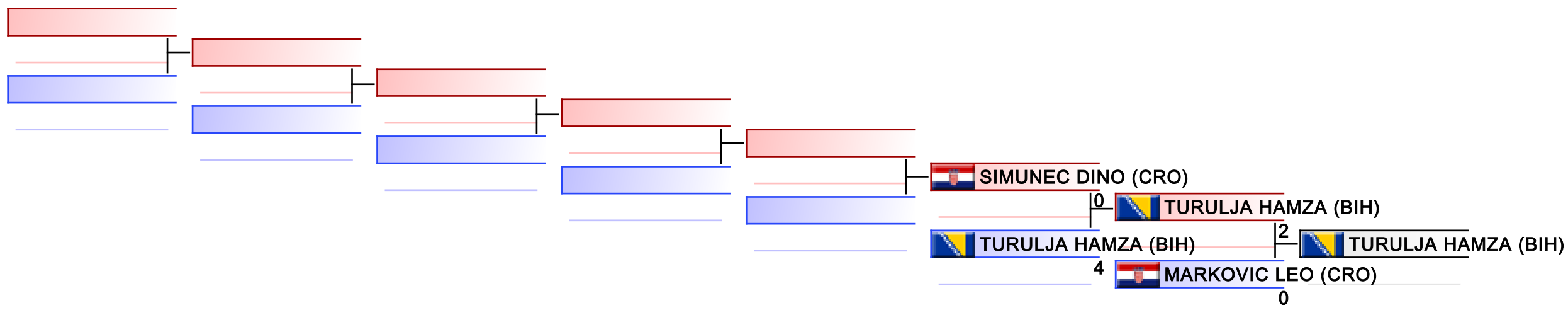

|           |  |  |  |  |  |  |  |
|-----------|--|--|--|--|--|--|--|
| Referees: |  |  |  |  |  |  |  |
|-----------|--|--|--|--|--|--|--|

# U21 KUMITE MALE -84 KG

21st Balkan Karate Championships for Cadets, Juniors and U21 - RIJEKA 2021, RIJEKA, CRO

Tatami  
3 11:35

Pool  
1/2

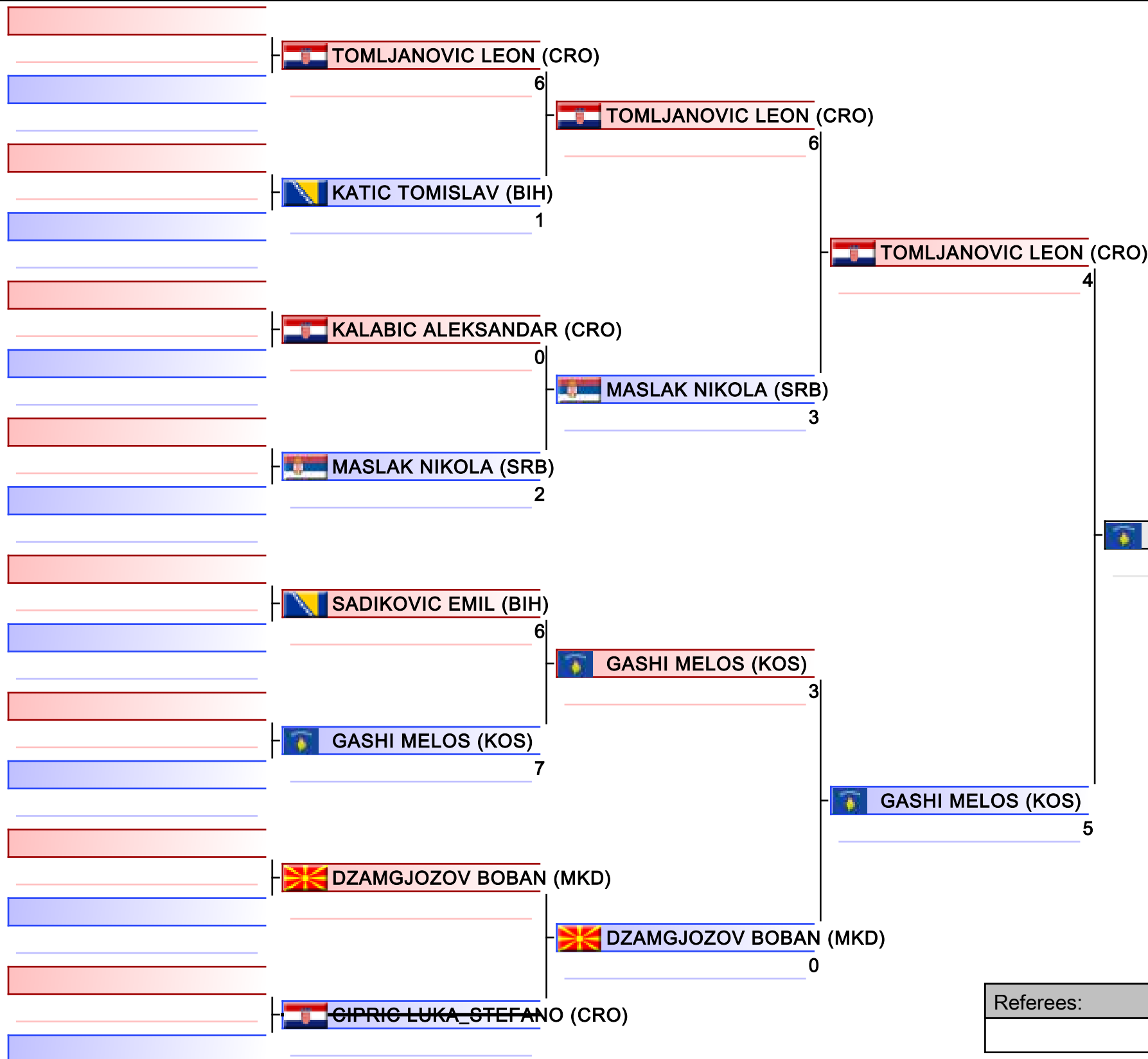

|                                 |
|---------------------------------|
| 1. DZUHO MAHIR (BIH)            |
| 2. GASHI MELOS (KOS)            |
| 3. TOMLJANOVIC LEON (CRO)       |
| 3. BALIKCIOGLU ABDULKERIM (TUR) |
| 5. SADIKOVIC EMIL (BIH)         |
| 5. MURADBASIC HARIS (BIH)       |
| 7. DZAMGJOZOV BOBAN (MKD)       |

|           |  |  |  |
|-----------|--|--|--|
| Referees: |  |  |  |
|           |  |  |  |

# U21 KUMITE MALE -84 KG

21st Balkan Karate Championships for Cadets, Juniors and U21 - RIJEKA 2021, RIJEKA, CRO

Tatami  
4 12:30

Pool  
2/2

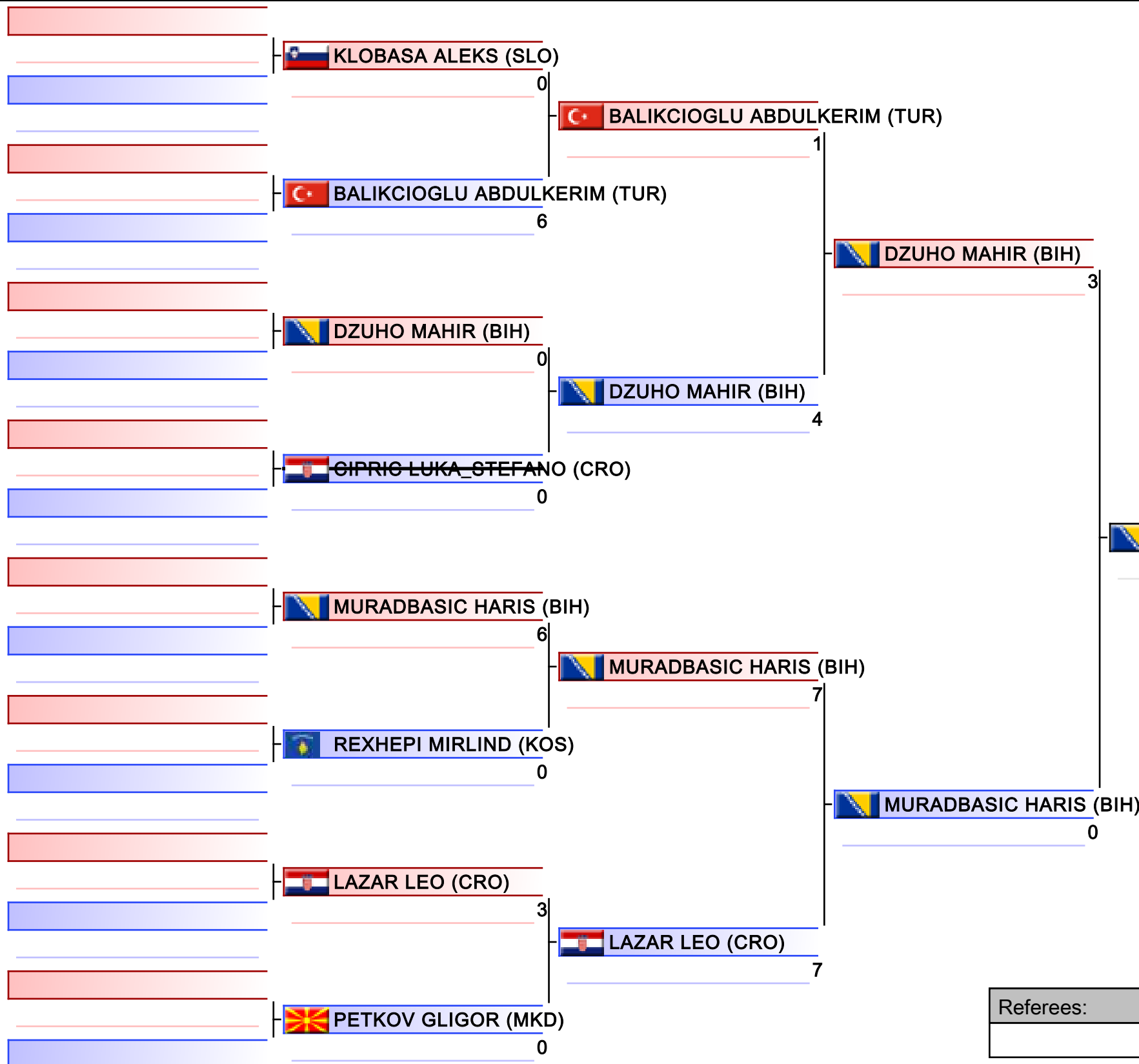

|                                 |
|---------------------------------|
| 1. DZUHO MAHIR (BIH)            |
| 2. GASHI MELOS (KOS)            |
| 3. TOMLJANOVIC LEON (CRO)       |
| 3. BALIKCIOGLU ABDULKERIM (TUR) |
| 5. SADIKOVIC EMIL (BIH)         |
| 5. MURADBASIC HARIS (BIH)       |
| 7. DZAMGJOZOV BOBAN (MKD)       |

|           |  |  |  |
|-----------|--|--|--|
| Referees: |  |  |  |
|           |  |  |  |

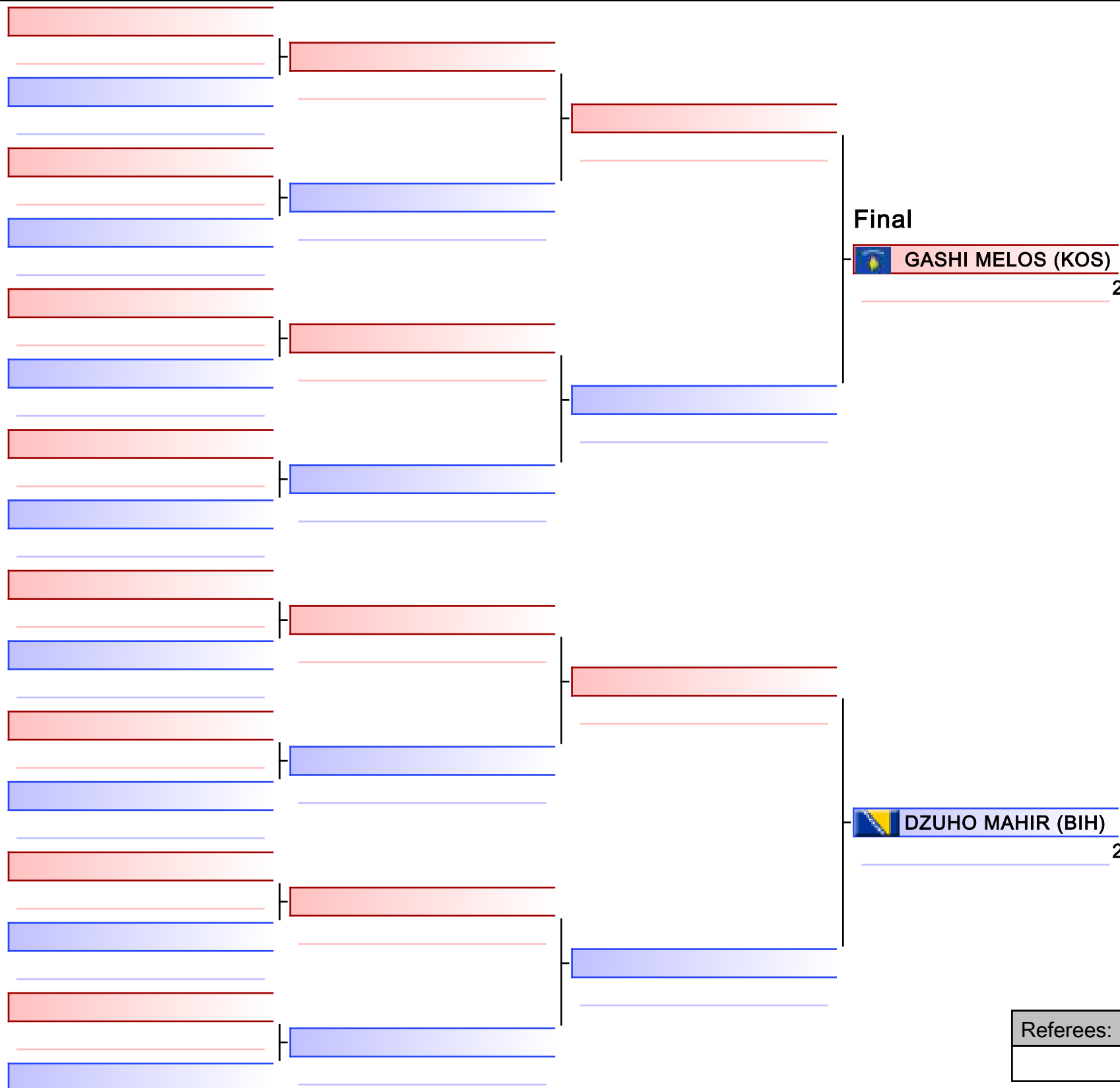

|                                 |
|---------------------------------|
| 1. DZUHO MAHIR (BIH)            |
| 2. GASHI MELOS (KOS)            |
| 3. TOMLJANOVIC LEON (CRO)       |
| 3. BALIKCIOGLU ABDULKERIM (TUR) |
| 5. SADIKOVIC EMIL (BIH)         |
| 5. MURADBASIC HARIS (BIH)       |
| 7. DZAMGJOZOV BOBAN (MKD)       |
|                                 |

|           |  |  |  |
|-----------|--|--|--|
| Referees: |  |  |  |
|           |  |  |  |



# U21 KUMITE MALE -84 KG

21st Balkan Karate Championships for Cadets, Juniors and U21 - RIJEKA 2021

Tatami  
3 12:20

Pool  
1

(c)sportdata GmbH & Co KG 2000-2021(2021-11-29 16:49) -WKF Approved- v 9.8.8 build 3 (2021-11-04) License: SDIL Sportdata Internal License 2021 (expire 2021-12-31)

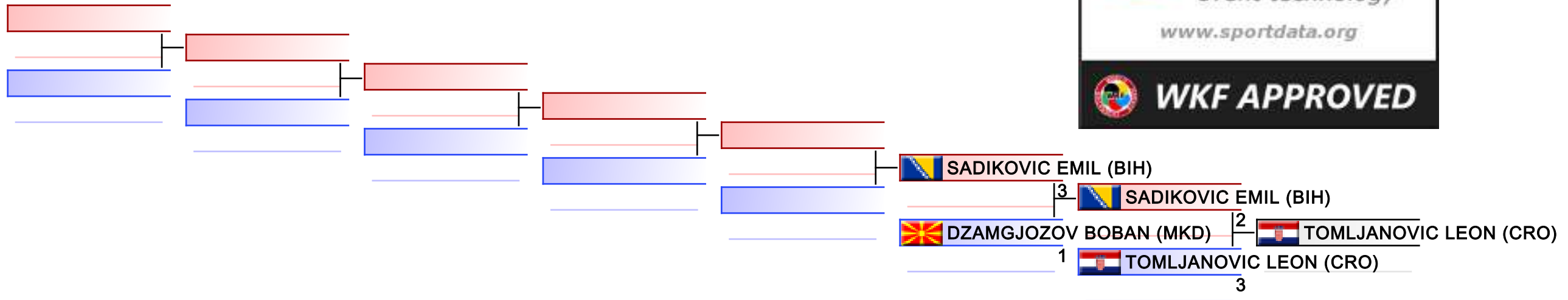

## REPECHAGE: (1)

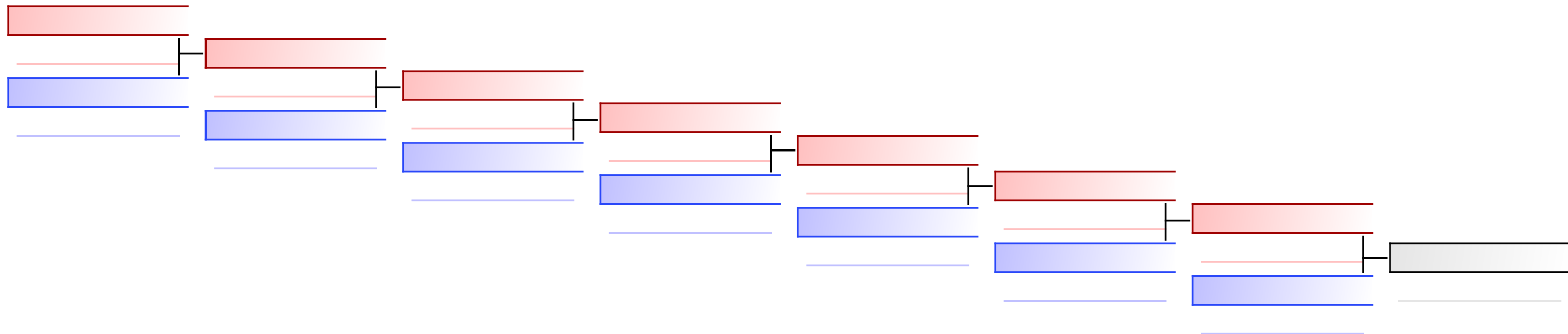

|           |  |  |  |  |  |  |  |
|-----------|--|--|--|--|--|--|--|
| Referees: |  |  |  |  |  |  |  |
|-----------|--|--|--|--|--|--|--|

# U21 KUMITE MALE -84 KG

21st Balkan Karate Championships for Cadets, Juniors and U21 - RIJEKA 2021

Tatami  
4 13:15

Pool  
2

(c)sportdata GmbH & Co KG 2000-2021(2021-11-29 16:49) -WKF Approved- v 9.8.8 build 3 (2021-11-04) License: SDIL Sportdata Internal License 2021 (expire 2021-12-31)

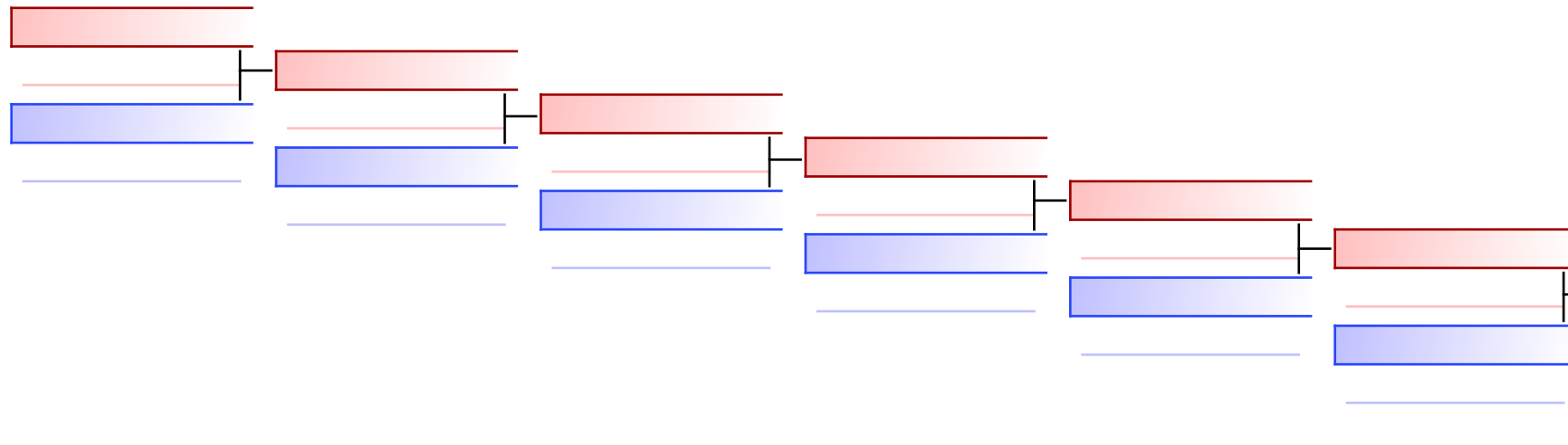

BALIKCIOGLU ABDULKERIM (TUR)

9 BALIKCIOGLU ABDULKERIM (TUR)

MURADBASIC HARIS (BIH)

1

## REPECHAGE: (2)

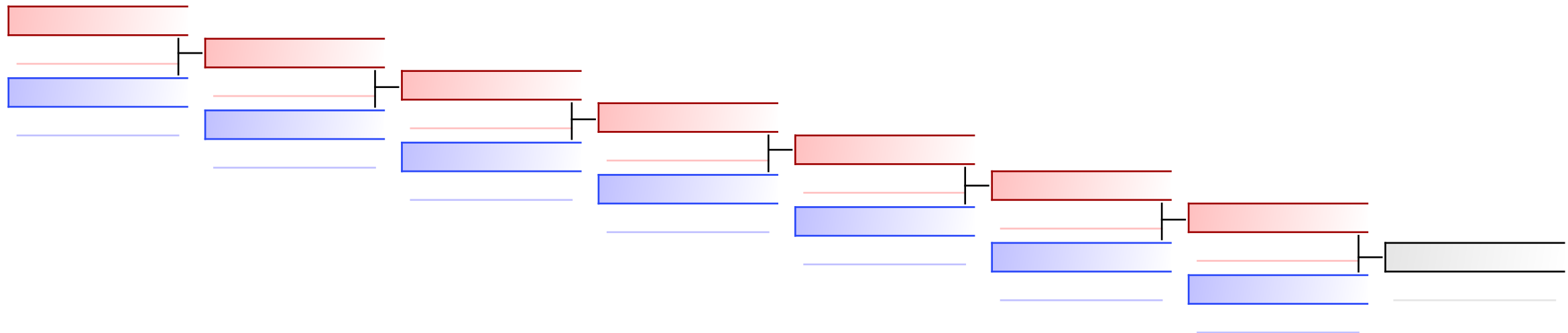

|           |  |  |  |  |  |  |  |
|-----------|--|--|--|--|--|--|--|
| Referees: |  |  |  |  |  |  |  |
|-----------|--|--|--|--|--|--|--|

# U21 KUMITE MALE 84+ KG

21st Balkan Karate Championships for Cadets, Juniors and U21 - RIJEKA 2021, RIJEKA, CRO

Tatami  
4 13:45

Pool  
1/1

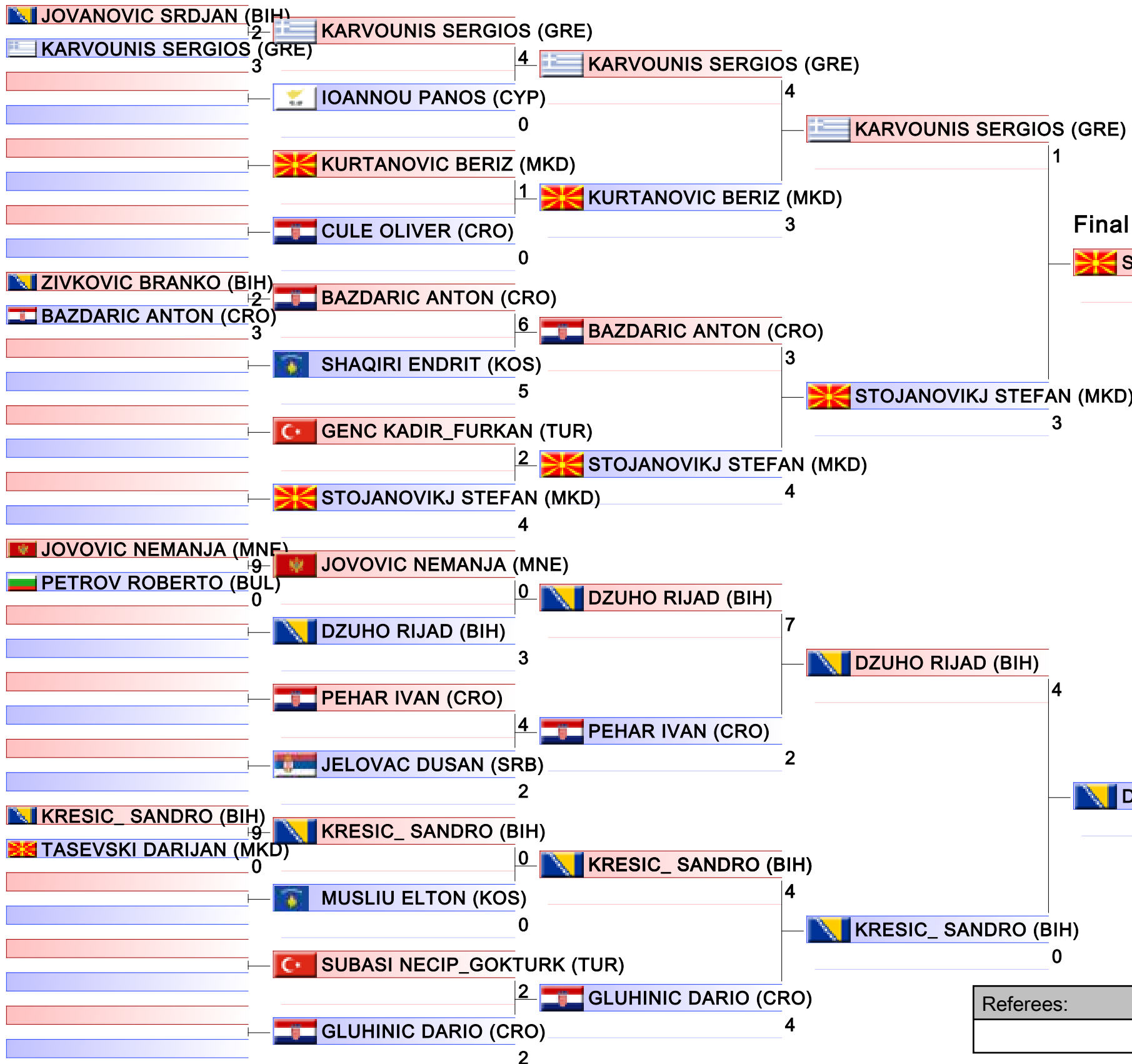

|                             |
|-----------------------------|
| 1. DZUHO RIJAD (BIH)        |
| 2. STOJANOVIKJ STEFAN (MKD) |
| 3. KRESIC SANDRO (BIH)      |
| 3. KARVOUNIS SERGIOS (GRE)  |
| 5. JOVOVIC NEMANJA (MNE)    |
| 5. BAZDARIC ANTON (CRO)     |
| 7. PEHAR IVAN (CRO)         |
| 7. GENC KADIR_FURKAN (TUR)  |

|           |  |  |  |
|-----------|--|--|--|
| Referees: |  |  |  |
|           |  |  |  |

# U21 KUMITE MALE 84+ KG

21st Balkan Karate Championships for Cadets, Juniors and U21 - RIJEKA 2021

Tatami  
4 15:35

Pool  
1

(c)sportdata GmbH & Co KG 2000-2021(2021-11-29 16:49) -WKF Approved- v 9.8.8 build 3 (2021-11-04) License: SDIL Sportdata Internal License 2021 (expire 2021-12-31)

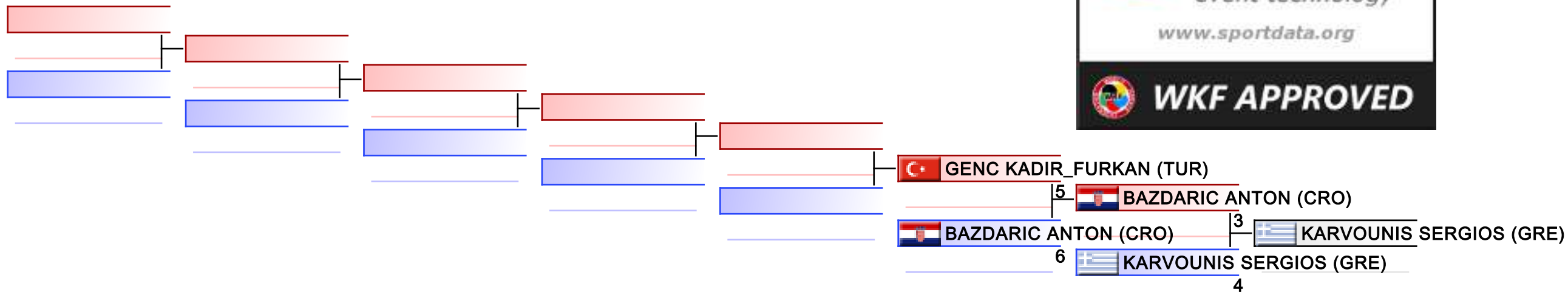

## REPECHAGE: (1)

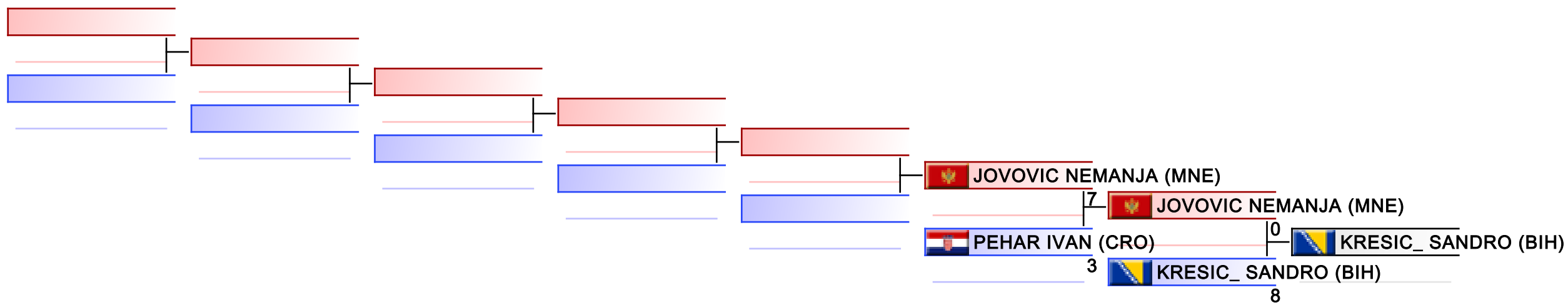

|           |  |  |  |  |  |  |  |
|-----------|--|--|--|--|--|--|--|
| Referees: |  |  |  |  |  |  |  |
|-----------|--|--|--|--|--|--|--|

**21st Balkan Karate Championships for Cadets,  
Juniors and U21 - RIJEKA 2021 - 2021-11-26**

**Official Results**

| <b>Cadet Kata Female</b> |                      |                        |   |                              |
|--------------------------|----------------------|------------------------|---|------------------------------|
| 1                        | MILOSEVIC NEDA       | SERBIA                 |    | SRB - SERBIA                 |
| 2                        | EVSAN ESMA SILA      | TURKEY                 |    | TUR - TURKEY                 |
| 3                        | SEGAVCIC KATIA       | CROATIA                |    | CRO - CROATIA                |
| 3                        | JOVANOVIC SAVA       | SERBIA                 |    | SRB - SERBIA                 |
| 5                        | STOJKOVA DANKA       | NORTH MACEDONIA        |    | MKD - NORTH MACEDONIA        |
| 5                        | TSIAKMAKI ATHINA     | GREECE                 |    | GRE - GREECE                 |
| 7                        | BOCKOR EMMA BERTA    | CROATIA                |    | CRO - CROATIA                |
| 7                        | MINGOVSKA ANASTASIJA | NORTH MACEDONIA        |    | MKD - NORTH MACEDONIA        |
| 9                        | STANOJEVIC KRISTINA  | BOSNIA AND HERZEGOVINA |    | BIH - BOSNIA AND HERZEGOVINA |
| 9                        | PESTALIC MERJEMA     | BOSNIA AND HERZEGOVINA |    | BIH - BOSNIA AND HERZEGOVINA |
| 11                       | KOCAN ARIJANA        | MONTENEGRO             |    | MNE - MONTENEGRO             |
| 11                       | LAZANSKI MAJA        | SLOVENIA               |    | SLO - SLOVENIA               |
| 13                       | DURDZIC IMANA        | BOSNIA AND HERZEGOVINA |    | BIH - BOSNIA AND HERZEGOVINA |
| 13                       | NASTAS PATRICIA      | ROMANIA                |    | ROU - ROMANIA                |
| 15                       | GRBIC GORDANA        | SERBIA                 |    | SRB - SERBIA                 |
| 15                       | PASALIC ESMA         | BOSNIA AND HERZEGOVINA |   | BIH - BOSNIA AND HERZEGOVINA |
| 17                       | COFIL FRANCESCA      | ROMANIA                |  | ROU - ROMANIA                |
| 17                       | BACIU MARIA          | ROMANIA                |  | ROU - ROMANIA                |
| 19                       | KOSTOVA VELIZARA     | BULGARIA               |  | BUL - BULGARIA               |
| 19                       | REGKLI THEONI        | GREECE                 |  | GRE - GREECE                 |
| 21                       | ZAGER HANA           | SLOVENIA               |  | SLO - SLOVENIA               |

| <b>Cadet Kata Male</b> |                          |                          |   |                              |
|------------------------|--------------------------|--------------------------|---|------------------------------|
| 1                      | DUGONJIC UROS            | SERBIA                   |  | SRB - SERBIA                 |
| 2                      | NIKOLIC DIMITRIJE        | SERBIA                   |  | SRB - SERBIA                 |
| 3                      | SALKIC TARIK             | BOSNIA AND HERZEGOVINA   |  | BIH - BOSNIA AND HERZEGOVINA |
| 3                      | HUIC DINO                | CROATIA                  |  | CRO - CROATIA                |
| 5                      | RADISAVLJEVIC JOVAN      | SERBIA                   |  | SRB - SERBIA                 |
| 5                      | POPTODOROV MARKO         | NORTH MACEDONIA          |  | MKD - NORTH MACEDONIA        |
| 7                      | FILES MARK               | CROATIA                  |  | CRO - CROATIA                |
| 7                      | KUCUKALTIN ALPARSLAN     | TURKEY                   |  | TUR - TURKEY                 |
| 9                      | BOSKOV ALEKSANDAR        | SERBIA                   |  | SRB - SERBIA                 |
| 9                      | GERSCHWITZ AJSEL         | MONTENEGRO               |  | MNE - MONTENEGRO             |
| 11                     | JANJIC ALEKSA            | MONTENEGRO               |  | MNE - MONTENEGRO             |
| 11                     | TOTH MATEJ               | CROATIA                  |  | CRO - CROATIA                |
| 13                     | DIMCHEVSKI MARIO         | NORTH MACEDONIA          |  | MKD - NORTH MACEDONIA        |
| 13                     | ROSIC RIJAD              | BOSNIA AND HERZEGOVINA   |  | BIH - BOSNIA AND HERZEGOVINA |
| 15                     | BUDAN PIRVU PATRICK ALEX | ROMANIA                  |  | ROU - ROMANIA                |
| 15                     | SADIKOVIC NADAL          | BOSNIA AND HERZEGOVINA   |  | BIH - BOSNIA AND HERZEGOVINA |
| 17                     | GASHI LEART              | KOSOVO KARATE FEDERATION |  | KOS - KOSOVO                 |

**21st Balkan Karate Championships for Cadets,  
Juniors and U21 - RIJEKA 2021 - 2021-11-26**

**Official Results**

|    |                         |         |   |               |  |
|----|-------------------------|---------|---|---------------|--|
| 17 | KEKO LUKA               | CROATIA |  | CRO - CROATIA |  |
| 19 | KOUTALIARIS DIMOSTHENIS | GREECE  |  | GRE - GREECE  |  |

**CADET KUMITE FEMALE -47 KG**

|   |                        |                        |   |                              |  |
|---|------------------------|------------------------|---|------------------------------|--|
| 1 | PAPPA CHRISTINA TRIADA | GREECE                 |  | GRE - GREECE                 |  |
| 2 | NASTAS PATRICIA        | ROMANIA                |  | ROU - ROMANIA                |  |
| 3 | BEYAZIT MENSURE        | TURKEY                 |  | TUR - TURKEY                 |  |
| 3 | LUJIC ANA              | CROATIA                |  | CRO - CROATIA                |  |
| 5 | SGARDELLI LJATIFI TEA  | CROATIA                |  | CRO - CROATIA                |  |
| 5 | KIRINIC LUCIJA         | CROATIA                |  | CRO - CROATIA                |  |
| 7 | TOSHEVA VICTORIA       | BULGARIA               |  | BUL - BULGARIA               |  |
| 7 | BEGANOVIC NINA         | BOSNIA AND HERZEGOVINA |  | BIH - BOSNIA AND HERZEGOVINA |  |

**CADET KUMITE FEMALE -54 KG**

|   |                      |                        |   |                              |  |
|---|----------------------|------------------------|---|------------------------------|--|
| 1 | XENOU LYDIA LAMPRINI | GREECE                 |    | GRE - GREECE                 |  |
| 2 | DAMJANOVIC JOVANA    | MONTENEGRO             |    | MNE - MONTENEGRO             |  |
| 3 | POZDERAC NINA        | BOSNIA AND HERZEGOVINA |    | BIH - BOSNIA AND HERZEGOVINA |  |
| 3 | SIPOVIC AJLA         | BOSNIA AND HERZEGOVINA |    | BIH - BOSNIA AND HERZEGOVINA |  |
| 5 | KLARIC KORINA        | CROATIA                |   | CRO - CROATIA                |  |
| 5 | BESLIJA NIKA         | CROATIA                |  | CRO - CROATIA                |  |
| 7 | VAJDA MAGDALENA      | CROATIA                |  | CRO - CROATIA                |  |
| 7 | JOKSIMOVIC MARTA     | SERBIA                 |  | SRB - SERBIA                 |  |
| 9 | DRAGOVIC PAOLA       | SERBIA                 |  | SRB - SERBIA                 |  |
| 9 | RUMENJAK RAFAELA     | CROATIA                |  | CRO - CROATIA                |  |

**CADET KUMITE FEMALE 54+ KG**

|    |                          |                          |   |                              |  |
|----|--------------------------|--------------------------|---|------------------------------|--|
| 1  | TOMIC SARA               | CROATIA                  |  | CRO - CROATIA                |  |
| 2  | NIJEMCEVIC ANA           | SERBIA                   |  | SRB - SERBIA                 |  |
| 3  | KALPAKLI IKLIM SEVVAL    | TURKEY                   |  | TUR - TURKEY                 |  |
| 3  | RAJIC DUNJA              | SERBIA                   |  | SRB - SERBIA                 |  |
| 5  | TOPIC KAJA               | BOSNIA AND HERZEGOVINA   |  | BIH - BOSNIA AND HERZEGOVINA |  |
| 5  | SEJDIU LORINDA           | KOSOVO KARATE FEDERATION |  | KOS - KOSOVO                 |  |
| 7  | ANASTASIOU MARIA GEORGIA | GREECE                   |  | GRE - GREECE                 |  |
| 7  | JEVTOVIC DUNJA           | SERBIA                   |  | SRB - SERBIA                 |  |
| 9  | SOPIJANI ERBLINA         | KOSOVO KARATE FEDERATION |  | KOS - KOSOVO                 |  |
| 9  | HUIU STEFANIA ALECSANDRA | ROMANIA                  |  | ROU - ROMANIA                |  |
| 11 | MANDIC MARIJA            | CROATIA                  |  | CRO - CROATIA                |  |

**CADET KUMITE MALE -52 KG**

|   |                |                        |   |                              |  |
|---|----------------|------------------------|---|------------------------------|--|
| 1 | ZOLOTA ISMAIL  | BOSNIA AND HERZEGOVINA |  | BIH - BOSNIA AND HERZEGOVINA |  |
| 2 | MIHAYLOV PETAR | BULGARIA               |  | BUL - BULGARIA               |  |
| 3 | VOJINOVIC BALS | MONTENEGRO             |  | MNE - MONTENEGRO             |  |
| 3 | HALILOVIC EMIR | BOSNIA AND HERZEGOVINA |  | BIH - BOSNIA AND HERZEGOVINA |  |

**21st Balkan Karate Championships for Cadets,  
Juniors and U21 - RIJEKA 2021 - 2021-11-26**

**Official Results**

|   |                         |                        |   |                              |  |
|---|-------------------------|------------------------|---|------------------------------|--|
| 5 | PAPADOPOULOS GEORGIOS   | GREECE                 |  | GRE - GREECE                 |  |
| 5 | GOKCEK SEMIH VOLKAN     | TURKEY                 |  | TUR - TURKEY                 |  |
| 7 | DIMCHEVSKI MARIO        | NORTH MACEDONIA        |  | MKD - NORTH MACEDONIA        |  |
| 7 | DRAGULIN ALFONSO ANDREI | ROMANIA                |  | ROU - ROMANIA                |  |
| 9 | ZAIMOVIC AMIL           | BOSNIA AND HERZEGOVINA |  | BIH - BOSNIA AND HERZEGOVINA |  |

**CADET KUMITE MALE -57 KG**

|   |                     |                        |   |                              |  |
|---|---------------------|------------------------|---|------------------------------|--|
| 1 | VUCKOVIC ALEKSANDAR | SERBIA                 |  | SRB - SERBIA                 |  |
| 2 | KARRAS PETROS       | GREECE                 |  | GRE - GREECE                 |  |
| 3 | NOVAKOVIC STRAHINJA | SERBIA                 |  | SRB - SERBIA                 |  |
| 3 | PAPPAS VASILEIOS    | GREECE                 |  | GRE - GREECE                 |  |
| 5 | STOIMENOV MIHAIL    | BULGARIA               |  | BUL - BULGARIA               |  |
| 5 | ESER BAYRAM ANIL    | TURKEY                 |  | TUR - TURKEY                 |  |
| 7 | PEJIC LUKA          | BOSNIA AND HERZEGOVINA |  | BIH - BOSNIA AND HERZEGOVINA |  |
| 7 | SEDIC TARIK         | BOSNIA AND HERZEGOVINA |  | BIH - BOSNIA AND HERZEGOVINA |  |
| 9 | DRAGAN MIHAI-ROBERT | ROMANIA                |  | ROU - ROMANIA                |  |

**CADET KUMITE MALE -63 KG**

|   |                     |                        |   |                              |  |
|---|---------------------|------------------------|---|------------------------------|--|
| 1 | SALKIC TARIK        | BOSNIA AND HERZEGOVINA |  | BIH - BOSNIA AND HERZEGOVINA |  |
| 2 | BLANUSA MARKO       | SERBIA                 |  | SRB - SERBIA                 |  |
| 3 | REDJEP RUSHTI       | NORTH MACEDONIA        |  | MKD - NORTH MACEDONIA        |  |
| 3 | DJURICIC NENAD      | MONTENEGRO             |  | MNE - MONTENEGRO             |  |
| 5 | VAKARELOV VLADISLAV | BULGARIA               |  | BUL - BULGARIA               |  |
| 5 | MILUNOVIC STEFAN    | SERBIA                 |  | SRB - SERBIA                 |  |
| 7 | GARACA ANES         | BOSNIA AND HERZEGOVINA |  | BIH - BOSNIA AND HERZEGOVINA |  |
| 7 | JOVANOVIH VUKASHIN  | NORTH MACEDONIA        |  | MKD - NORTH MACEDONIA        |  |
| 9 | CARBUNEANU RADU     | ROMANIA                |  | ROU - ROMANIA                |  |
| 9 | SONJE DOMINIK       | CROATIA                |  | CRO - CROATIA                |  |

**CADET KUMITE MALE -70 KG**

|   |                   |                          |   |                              |  |
|---|-------------------|--------------------------|---|------------------------------|--|
| 1 | HUKARA SANJIN     | BOSNIA AND HERZEGOVINA   |  | BIH - BOSNIA AND HERZEGOVINA |  |
| 2 | STRAHIJA SVEN     | CROATIA                  |  | CRO - CROATIA                |  |
| 3 | PSOMAS ILIAS      | GREECE                   |  | GRE - GREECE                 |  |
| 3 | AYDEMIR SULEYMAN  | TURKEY                   |  | TUR - TURKEY                 |  |
| 5 | MORAITIS NIKOLAOS | GREECE                   |  | GRE - GREECE                 |  |
| 5 | TASIC NEMANJA     | SERBIA                   |  | SRB - SERBIA                 |  |
| 7 | MALOKU ORGES      | KOSOVO KARATE FEDERATION |  | KOS - KOSOVO                 |  |
| 7 | NEDIC LEON        | CROATIA                  |  | CRO - CROATIA                |  |
| 9 | KRNJAJAC MILOS    | SERBIA                   |  | SRB - SERBIA                 |  |

**CADET KUMITE MALE 70+ KG**

|   |                    |        |   |              |  |
|---|--------------------|--------|---|--------------|--|
| 1 | MILOSEVIC ILIJA    | SERBIA |  | SRB - SERBIA |  |
| 2 | AYHAN SULEYMAN EGE | TURKEY |  | TUR - TURKEY |  |

**21st Balkan Karate Championships for Cadets,  
Juniors and U21 - RIJEKA 2021 - 2021-11-26**

**Official Results**

|   |                      |                             |   |                                 |  |
|---|----------------------|-----------------------------|---|---------------------------------|--|
| 3 | BASAROV ANDREJ       | NORTH MACEDONIA             |  | MKD - NORTH MACEDONIA           |  |
| 3 | STEFANIDIS PETROS    | GREECE                      |  | GRE - GREECE                    |  |
| 5 | MIJANOVIC RASTKO     | SERBIA                      |  | SRB - SERBIA                    |  |
| 5 | GASHI LEART          | KOSOVO KARATE<br>FEDERATION |  | KOS - KOSOVO                    |  |
| 7 | ATANASOV TEODOR      | BULGARIA                    |  | BUL - BULGARIA                  |  |
| 7 | VITELIC PAPIKA TIBOR | CROATIA                     |  | CRO - CROATIA                   |  |
| 9 | SAPINA LUKA          | BOSNIA AND<br>HERZEGOVINA   |  | BIH - BOSNIA AND<br>HERZEGOVINA |  |

**CADET KUMITE TEAM FEMALE**

|   |  |                             |   |                                 |  |
|---|--|-----------------------------|---|---------------------------------|--|
| 1 | CROATIA<br>- BESLIJA NIKA<br>- LUJIC ANA<br>- TOMIC SARA<br>- VAJDA MAGDALENA                      | CROATIA                     |  | CRO - CROATIA                   |  |
| 2 | SERBIA<br>- RAUKOVIC ANDJELA<br>- RAJIC DUNJA<br>- NIJEMCEVIC_ ANA<br>- DRAGOVIC PAOLA             | SERBIA                      |  | SRB - SERBIA                    |  |
| 3 | ROMANIA<br>- ADOCHITEI MARIA<br>- CRUCERU ALESSIA<br>- IVASCU LARISA_ ADRIANA<br>- NASTAS PATRICIA | ROMANIA                     |  | ROU - ROMANIA                   |  |
| 3 | BULGARIA<br>- KOSTOVA VELIZARA<br>- STOIMENOVA VENETA<br>- STOYANOVA YOANNA<br>- TSANEVA TEODORA   | BULGARIA                    |  | BUL - BULGARIA                  |  |
| 5 | KOSOVO<br>- IBRAHIMI QENDRESA<br>- MAHALLA DIELLZA<br>- SEJDIU LORINDA<br>- SOPIJANI ERBLINA       | KOSOVO KARATE<br>FEDERATION |  | KOS - KOSOVO                    |  |
| 5 | BOSNIA AND HERZEGOVINA<br>- BEGANOVIC NINA<br>- TOPIC KAJA<br>- MUHOVIC NADJA<br>- POZDERAC NINA   | BOSNIA AND<br>HERZEGOVINA   |  | BIH - BOSNIA AND<br>HERZEGOVINA |  |

**CADET KUMITE TEAM MALE**

|   |  |                           |   |                                 |  |
|---|--|---------------------------|---|---------------------------------|--|
| 1 | BOSNIA AND HERZEGOVINA<br>- CUBARA_ EMAN<br>- DABIC MILAN<br>- HODZIC AMAR<br>- HUKARA SANJIN<br>- JASAREVIC KERIM<br>- SALKIC TARIK<br>- VUJMILOVIC KOSTA | BOSNIA AND<br>HERZEGOVINA |  | BIH - BOSNIA AND<br>HERZEGOVINA |  |
| 2 | BULGARIA   | BULGARIA                  |  | BUL - BULGARIA                  |  |



**21st Balkan Karate Championships for Cadets,  
Juniors and U21 - RIJEKA 2021 - 2021-11-26**

**Official Results**

|   |   |                 |   |                       |  |
|---|---|-----------------|---|-----------------------|--|
|   | - ATANASOV TEODOR<br>- HRISTAKIEV ALEKSANDER<br>- MIHAYLOV PETAR<br>- MILENKOV DEYAN<br>- STOIMENOV MIHAIL<br>- VAKARELOV VLADISLAV<br>- VASILEV HRISTIAN   |                 |   |                       |  |
| 3 | CROATIA<br>- BOGAT MARTIN<br>- CUTURA TONI<br>- FRANK KRISTIJAN<br>- GONDI NIKOLA<br>- SONJE DOMINIK<br>- STRAHIJA SVEN<br>- VITELIC_PAPRIKA TIBOR  | CROATIA         |    | CRO - CROATIA         |  |
| 3 | GREECE<br>- STEFANIDIS PETROS<br>- PSOMAS ILIAS<br>- BITSORIS_ANDREAS<br>- KARRAS PETROS<br>- PAPPAS VASILEIOS<br>- PAPADOPOULOS GEORGIOS<br>- KOUTALIARIS DIMOSTHENIS                                    | GREECE          |    | GRE - GREECE          |  |
| 5 | MACEDONIA KUMITE TEAM<br>MALE<br>- DIMCHEVSKI MARIO<br>- BASAROV ANDREJ<br>- JOVANOVIČ VUKASHIN<br>- MEMETI BESART<br>- RAMADANI AZIZ<br>- RUSHITI REDZEP<br>- SPASOV VIKTOR                              | NORTH MACEDONIA |    | MKD - NORTH MACEDONIA |  |
| 5 | SLOVENIA<br>- POGACAR JAKA<br>- TRATNIK ALEN<br>- ZUMER JAKOB<br>- ZIBRET BOR<br>- PASIC ISAK<br>- BOROVIK_NIK  | SLOVENIA        |  | SLO - SLOVENIA        |  |
| 7 | ROMANIA<br>- CARBUNEANU RADU<br>- DRAGAN MIHAI-ROBERT<br>- DRAGULIN ALFONSO_ANDREI<br>- GEORGESCU<br>THEODOR_PETRU<br>- MOLDOVAN<br>DAVIDE_ALESSANDRO<br>- MUNTEANU<br>MIHAI_ALEXANDRU_<br>- SPITA DANTES | ROMANIA         |  | ROU - ROMANIA         |  |

**Junior Kata Female**

|   |                   |          |   |                |  |
|---|-------------------|----------|---|----------------|--|
| 1 | TUREMEN DAMLA SU  | TURKEY   |  | TUR - TURKEY   |  |
| 2 | SENGUL HULYANUR   | TURKEY   |  | TUR - TURKEY   |  |
| 3 | BRAJA KLARA       | CROATIA  |  | CRO - CROATIA  |  |
| 3 | KOYUNCU PERI      | TURKEY   |  | TUR - TURKEY   |  |
| 5 | KOBAL PAHOR LEA   | SLOVENIA |  | SLO - SLOVENIA |  |
| 5 | NADIZAR LANA TISA | SLOVENIA |  | SLO - SLOVENIA |  |
| 7 | ASLI PEHLIVAN     | TURKEY   |  | TUR - TURKEY   |  |

**21st Balkan Karate Championships for Cadets,  
Juniors and U21 - RIJEKA 2021 - 2021-11-26**

**Official Results**

|    |                         |                          |   |                              |  |
|----|-------------------------|--------------------------|---|------------------------------|--|
| 7  | COSTANZO ISABELLA JOANA | ROMANIA                  |    | ROU - ROMANIA                |  |
| 9  | LAZAREVSKI MINA         | SERBIA                   |    | SRB - SERBIA                 |  |
| 9  | PALIAGA FLAVIA          | CROATIA                  |    | CRO - CROATIA                |  |
| 11 | ARSOVSKA MARTINA        | NORTH MACEDONIA          |    | MKD - NORTH MACEDONIA        |  |
| 11 | HORVAT STELA            | CROATIA                  |    | CRO - CROATIA                |  |
| 13 | KUTIJA ALJA             | SLOVENIA                 |    | SLO - SLOVENIA               |  |
| 13 | JOVANOVIC KRSTINA       | SERBIA                   |    | SRB - SERBIA                 |  |
| 15 | MARKOVIC MILA           | MONTENEGRO               |    | MNE - MONTENEGRO             |  |
| 15 | TANOVIC EMINA           | BOSNIA AND HERZEGOVINA   |    | BIH - BOSNIA AND HERZEGOVINA |  |
| 17 | RADOVANOVIC ALEKSANDRA  | SERBIA                   |    | SRB - SERBIA                 |  |
| 17 | ARIFI ENKELA            | KOSOVO KARATE FEDERATION |    | KOS - KOSOVO                 |  |
| 17 | FAJFER LANA             | SLOVENIA                 |    | SLO - SLOVENIA               |  |
| 17 | NIKOLIC MILICA          | SERBIA                   |    | SRB - SERBIA                 |  |
| 21 | DURAKOVIC SEJMA         | BOSNIA AND HERZEGOVINA   |    | BIH - BOSNIA AND HERZEGOVINA |  |
| 21 | BANEASU MICHELLE        | ROMANIA                  |    | ROU - ROMANIA                |  |
| 21 | SARKINOVIC UNA          | BOSNIA AND HERZEGOVINA   |   | BIH - BOSNIA AND HERZEGOVINA |  |
| 21 | LOKI ALMA               | KOSOVO KARATE FEDERATION |  | KOS - KOSOVO                 |  |
| 25 | KOKKOTA ANASTASIA       | GREECE                   |  | GRE - GREECE                 |  |
| 25 | RADOVANOVIC DANICA      | MONTENEGRO               |  | MNE - MONTENEGRO             |  |

**Junior Kata Male**

|    |                         |                        |   |                              |  |
|----|-------------------------|------------------------|---|------------------------------|--|
| 1  | ASLAN GORKEM            | TURKEY                 |  | TUR - TURKEY                 |  |
| 2  | KILIC YUSUF             | TURKEY                 |  | TUR - TURKEY                 |  |
| 3  | KOUKOUSELIS IOANNIS     | GREECE                 |  | GRE - GREECE                 |  |
| 3  | VULPOIU EDUARD          | ROMANIA                |  | ROU - ROMANIA                |  |
| 5  | DJOKIC ANDRIJA          | SERBIA                 |  | SRB - SERBIA                 |  |
| 5  | MOCNIK TIMI             | SLOVENIA               |  | SLO - SLOVENIA               |  |
| 7  | TSIAKMAKIS FOTIOS       | GREECE                 |  | GRE - GREECE                 |  |
| 7  | VULPOIU EDUARD          | ROMANIA                |  | ROU - ROMANIA                |  |
| 9  | MILIC NIKOLA            | MONTENEGRO             |  | MNE - MONTENEGRO             |  |
| 9  | AKBABA ALI EFE          | TURKEY                 |  | TUR - TURKEY                 |  |
| 11 | SOPER ERIK              | CROATIA                |  | CRO - CROATIA                |  |
| 11 | SPASOVSKI DAVID         | NORTH MACEDONIA        |  | MKD - NORTH MACEDONIA        |  |
| 13 | MATUSKI GEORGI          | BULGARIA               |  | BUL - BULGARIA               |  |
| 13 | SEKULIC LAZAR           | MONTENEGRO             |  | MNE - MONTENEGRO             |  |
| 15 | HALILOVIC MUAMER        | BOSNIA AND HERZEGOVINA |  | BIH - BOSNIA AND HERZEGOVINA |  |
| 15 | SLUGA JURE              | SLOVENIA               |  | SLO - SLOVENIA               |  |
| 17 | PESHKOV ANDREJ          | NORTH MACEDONIA        |  | MKD - NORTH MACEDONIA        |  |
| 17 | BRAVARIC CILO DAMJAN    | CROATIA                |  | CRO - CROATIA                |  |
| 19 | PAVLOVIC STEFAN         | SERBIA                 |  | SRB - SERBIA                 |  |
| 19 | ANDRIC HRISTIJAN        | NORTH MACEDONIA        |  | MKD - NORTH MACEDONIA        |  |
| 21 | STOJANCEVSKI ALEKSANDAR | NORTH MACEDONIA        |  | MKD - NORTH MACEDONIA        |  |

**21st Balkan Karate Championships for Cadets,  
Juniors and U21 - RIJEKA 2021 - 2021-11-26**

**Official Results**

|    |                       |                          |   |               |  |
|----|-----------------------|--------------------------|---|---------------|--|
| 21 | HALILOSMANI NORIK     | KOSOVO KARATE FEDERATION |  | KOS - KOSOVO  |  |
| 23 | GRIGORIU STEFAN ANTON | ROMANIA                  |  | ROU - ROMANIA |  |

**JUNIOR KUMITE FEMALE -48 KG**

|   |                      |                        |   |                              |  |
|---|----------------------|------------------------|---|------------------------------|--|
| 1 | PECEVSKA IVA         | NORTH MACEDONIA        |  | MKD - NORTH MACEDONIA        |  |
| 2 | KOCKAREVIC LANA      | CROATIA                |  | CRO - CROATIA                |  |
| 3 | MAGAJNA MASA         | SLOVENIA               |  | SLO - SLOVENIA               |  |
| 3 | KAYACAN HATICE SENNA | TURKEY                 |  | TUR - TURKEY                 |  |
| 5 | HRBAT ELMEDINA       | BOSNIA AND HERZEGOVINA |  | BIH - BOSNIA AND HERZEGOVINA |  |
| 5 | GEORGOULEA MYRTO     | GREECE                 |  | GRE - GREECE                 |  |
| 7 | DAVIDOVSKA ANGELA    | NORTH MACEDONIA        |  | MKD - NORTH MACEDONIA        |  |
| 7 | VESIC MAGDALENA      | BOSNIA AND HERZEGOVINA |  | BIH - BOSNIA AND HERZEGOVINA |  |

**JUNIOR KUMITE FEMALE -53 KG**

|   |                       |                          |   |                              |  |
|---|-----------------------|--------------------------|---|------------------------------|--|
| 1 | SGARDELLI EMA         | CROATIA                  |    | CRO - CROATIA                |  |
| 2 | SIPOVIC EMINA         | BOSNIA AND HERZEGOVINA   |    | BIH - BOSNIA AND HERZEGOVINA |  |
| 3 | TZILIA STYLIANI-ELENI | GREECE                   |    | GRE - GREECE                 |  |
| 3 | MAMELEDZIJA TIA       | CROATIA                  |   | CRO - CROATIA                |  |
| 5 | FONIQI ANILA          | KOSOVO KARATE FEDERATION |  | KOS - KOSOVO                 |  |
| 5 | KALAJDZIC SARA        | SERBIA                   |  | SRB - SERBIA                 |  |
| 7 | ALIU RUDINA           | NORTH MACEDONIA          |  | MKD - NORTH MACEDONIA        |  |
| 7 | ANDREI LORELLEY       | ROMANIA                  |  | ROU - ROMANIA                |  |
| 9 | LOKI ALMA             | KOSOVO KARATE FEDERATION |  | KOS - KOSOVO                 |  |

**JUNIOR KUMITE FEMALE -59 KG**

|   |                        |                        |   |                              |  |
|---|------------------------|------------------------|---|------------------------------|--|
| 1 | KOXHA ERA              | NORTH MACEDONIA        |  | MKD - NORTH MACEDONIA        |  |
| 2 | MILUTINOVIC ALEKSANDRA | SERBIA                 |  | SRB - SERBIA                 |  |
| 3 | KOVAC IRIS             | CROATIA                |  | CRO - CROATIA                |  |
| 3 | AVZNER ZOJA            | SLOVENIA               |  | SLO - SLOVENIA               |  |
| 5 | GUSO DZEJLAN           | BOSNIA AND HERZEGOVINA |  | BIH - BOSNIA AND HERZEGOVINA |  |
| 5 | FARMAKI KASSIANI       | GREECE                 |  | GRE - GREECE                 |  |
| 7 | SARKINOVIC UNA         | BOSNIA AND HERZEGOVINA |  | BIH - BOSNIA AND HERZEGOVINA |  |
| 7 | DJORDJEVIC KRISTINA    | SERBIA                 |  | SRB - SERBIA                 |  |
| 9 | ZUGCIC DORA            | CROATIA                |  | CRO - CROATIA                |  |

**JUNIOR KUMITE FEMALE 59+ KG**

|   |                      |                        |   |                              |  |
|---|----------------------|------------------------|---|------------------------------|--|
| 1 | COMAN MARIA CRISTINA | ROMANIA                |  | ROU - ROMANIA                |  |
| 2 | CUCAK NIKOLINA       | BOSNIA AND HERZEGOVINA |  | BIH - BOSNIA AND HERZEGOVINA |  |
| 3 | IBRAHIMOVIC MELINA   | BOSNIA AND HERZEGOVINA |  | BIH - BOSNIA AND HERZEGOVINA |  |
| 3 | BOTA DIJANA          | SERBIA                 |  | SRB - SERBIA                 |  |
| 5 | FILIPOV NEVENA       | SERBIA                 |  | SRB - SERBIA                 |  |
| 5 | FILIPOVIC ANA        | CROATIA                |  | CRO - CROATIA                |  |

**21st Balkan Karate Championships for Cadets,  
Juniors and U21 - RIJEKA 2021 - 2021-11-26**

**Official Results**

|   |                      |        |   |              |  |
|---|----------------------|--------|---|--------------|--|
| 7 | IOSIF EVA            | GREECE |  | GRE - GREECE |  |
| 7 | STEFANIDOU CHRYSOULA | GREECE |  | GRE - GREECE |  |
| 9 | GRCAK JANA           | SERBIA |  | SRB - SERBIA |  |

**JUNIOR KUMITE MALE -55 KG**

|   |                        |                        |   |                              |  |
|---|------------------------|------------------------|---|------------------------------|--|
| 1 | HALICI MERT            | TURKEY                 |  | TUR - TURKEY                 |  |
| 2 | DOGARU ALEXANDRU IONUT | ROMANIA                |  | ROU - ROMANIA                |  |
| 3 | BELISTOJANOSKI MATEJ   | NORTH MACEDONIA        |  | MKD - NORTH MACEDONIA        |  |
| 3 | STANIC MIHAJLO         | BOSNIA AND HERZEGOVINA |  | BIH - BOSNIA AND HERZEGOVINA |  |
| 5 | RAONIC ALEKSANDAR      | BOSNIA AND HERZEGOVINA |  | BIH - BOSNIA AND HERZEGOVINA |  |
| 5 | CUKOVIC LUKA           | BOSNIA AND HERZEGOVINA |  | BIH - BOSNIA AND HERZEGOVINA |  |
| 7 | CUMBO NIKOLA           | SERBIA                 |  | SRB - SERBIA                 |  |
| 7 | DONADIC NINO           | CROATIA                |  | CRO - CROATIA                |  |

**JUNIOR KUMITE MALE -61 KG**

|   |                      |                          |   |                       |  |
|---|----------------------|--------------------------|---|-----------------------|--|
| 1 | YILDIRIM HASAN CELAL | TURKEY                   |    | TUR - TURKEY          |  |
| 2 | NASTESKI MATIJA      | CROATIA                  |    | CRO - CROATIA         |  |
| 3 | IBRAHIMI DREN        | KOSOVO KARATE FEDERATION |   | KOS - KOSOVO          |  |
| 3 | TORNACI ERHAN        | ROMANIA                  |  | ROU - ROMANIA         |  |
| 5 | PETRESKI STEFAN      | NORTH MACEDONIA          |  | MKD - NORTH MACEDONIA |  |
| 5 | SHAQIRI NEDIM        | NORTH MACEDONIA          |  | MKD - NORTH MACEDONIA |  |
| 7 | BILJALI ILI          | NORTH MACEDONIA          |  | MKD - NORTH MACEDONIA |  |
| 7 | ZARIC VID            | SLOVENIA                 |  | SLO - SLOVENIA        |  |
| 9 | DEMIRI LUAN          | KOSOVO KARATE FEDERATION |  | KOS - KOSOVO          |  |

**JUNIOR KUMITE MALE -68 KG**

|   |                          |          |   |                |  |
|---|--------------------------|----------|---|----------------|--|
| 1 | MARKOVIC MIHAJLO         | SERBIA   |  | SRB - SERBIA   |  |
| 2 | ISAKOVIC KENAN           | SLOVENIA |  | SLO - SLOVENIA |  |
| 3 | ORLANDIC PETAR           | SERBIA   |  | SRB - SERBIA   |  |
| 3 | DUGEROGLU EFE            | TURKEY   |  | TUR - TURKEY   |  |
| 5 | KITSIOS CHRISTOFOROS     | CYPRUS   |  | CYP - CYPRUS   |  |
| 5 | NICOLAOU IASONAS IOANNIS | CYPRUS   |  | CYP - CYPRUS   |  |
| 7 | TURKMENOGU MUHAMMET      | TURKEY   |  | TUR - TURKEY   |  |
| 7 | VASILJ ANDRIJA           | CROATIA  |  | CRO - CROATIA  |  |
| 9 | TERIHAJ IVAN             | CROATIA  |  | CRO - CROATIA  |  |
| 9 | MYTILIOS KONSTANTINOS    | GREECE   |  | GRE - GREECE   |  |

**JUNIOR KUMITE MALE -76 KG**









|   |                          |                        |   |                              |  |
|---|--------------------------|------------------------|---|------------------------------|--|
| 1 | HALILOVIC OMAR           | BOSNIA AND HERZEGOVINA |  | BIH - BOSNIA AND HERZEGOVINA |  |
| 2 | KATSAKOULAS CHRISTOFOROS | GREECE                 |  | GRE - GREECE                 |  |
| 3 | PETRESKI SIMON           | NORTH MACEDONIA        |  | MKD - NORTH MACEDONIA        |  |
| 3 | ANGELOVSKI ANDREJ        | NORTH MACEDONIA        |  | MKD - NORTH MACEDONIA        |  |
| 5 | AKCA SAMIL               | TURKEY                 |  | TUR - TURKEY                 |  |
| 5 | TRAJKOVSKI VITOMIR       | NORTH MACEDONIA        |  | MKD - NORTH MACEDONIA        |  |

**21st Balkan Karate Championships for Cadets,  
Juniors and U21 - RIJEKA 2021 - 2021-11-26**

**Official Results**

|   |                     |                        |   |                              |  |
|---|---------------------|------------------------|---|------------------------------|--|
| 7 | GIRIC LUKA          | SERBIA                 |  | SRB - SERBIA                 |  |
| 7 | DUBRAVCIC AXEL ADAM | CROATIA                |  | CRO - CROATIA                |  |
| 9 | BARLOV ADIN         | BOSNIA AND HERZEGOVINA |  | BIH - BOSNIA AND HERZEGOVINA |  |
| 9 | ZIVKOVIC OGNJEN     | SERBIA                 |  | SRB - SERBIA                 |  |

**JUNIOR KUMITE MALE 76+ KG**

|   |                    |                        |   |                              |  |
|---|--------------------|------------------------|---|------------------------------|--|
| 1 | BOSTANDZIC ANES    | BOSNIA AND HERZEGOVINA |  | BIH - BOSNIA AND HERZEGOVINA |  |
| 2 | BULAJIC VUKAN      | SERBIA                 |  | SRB - SERBIA                 |  |
| 3 | POTPARA LAZAR      | MONTENEGRO             |  | MNE - MONTENEGRO             |  |
| 3 | VASILIC MIHAJLO    | SERBIA                 |  | SRB - SERBIA                 |  |
| 5 | NOVICKI ALEKSANDAR | BOSNIA AND HERZEGOVINA |  | BIH - BOSNIA AND HERZEGOVINA |  |
| 5 | MOISE LEONARD      | ROMANIA                |  | ROU - ROMANIA                |  |
| 7 | OSMANI JASIN       | NORTH MACEDONIA        |  | MKD - NORTH MACEDONIA        |  |
| 7 | PEJOVIC UGLJESA    | SERBIA                 |  | SRB - SERBIA                 |  |
| 9 | MOCANU VLADUT PAUL | ROMANIA                |  | ROU - ROMANIA                |  |
| 9 | KATANEC JAN        | CROATIA                |  | CRO - CROATIA                |  |

**JUNIOR KUMITE TEAM FEMALE**

|   |   |                          |   |                              |  |
|---|---|--------------------------|---|------------------------------|--|
| 1 | KOSOVO<br>- FONIQI ANILA<br>- GASHI VALEZA<br>- MUSTAFA BEHIJE<br>- OSMANI RINESA                   | KOSOVO KARATE FEDERATION |  | KOS - KOSOVO                 |  |
| 2 | CROATIA<br>- GOLOMBOS NIKOLINA<br>- KOVAC IRIS<br>- LISAC LAURA<br>- SGARDELLI EMA                  | CROATIA                  |  | CRO - CROATIA                |  |
| 3 | GREECE<br>- IOSIF EVA<br>- FARMAKI KASSIANI<br>- LYRITSI VASILIKI<br>- TZILIA STYLIANI-ELENI        | GREECE                   |  | GRE - GREECE                 |  |
| 3 | BOSNIA AND HERZEGOVINA<br>- CUCAK NIKOLINA<br>- LEKANIC SELENA<br>- SIPOVIC EMINA<br>- SOFTIC DINKA | BOSNIA AND HERZEGOVINA   |  | BIH - BOSNIA AND HERZEGOVINA |  |
| 5 | SERBIA<br>- GRCAK JANA<br>- FILIPOV NEVENA<br>- IVANOVIC ANDJELA<br>- BOTA DIJANA                   | SERBIA                   |  | SRB - SERBIA                 |  |
| 5 | SLOVENIA<br>- ZIBRET ZALA_MARIA<br>- SEVER ANA<br>- MAGAJNA MASA<br>- AVZNER ZOJA                   | SLOVENIA                 |  | SLO - SLOVENIA               |  |

**JUNIOR KUMITE TEAM MALE**

|   |                        |                        |   |                              |  |
|---|------------------------|------------------------|---|------------------------------|--|
| 1 | BOSNIA AND HERZEGOVINA | BOSNIA AND HERZEGOVINA |  | BIH - BOSNIA AND HERZEGOVINA |  |
|---|------------------------|------------------------|---|------------------------------|--|

**21st Balkan Karate Championships for Cadets,  
Juniors and U21 - RIJEKA 2021 - 2021-11-26**

**Official Results**

|   |  |                             |   |               |
|---|--|-----------------------------|---|---------------|
|   | - NOVICKI ALEKSANDAR<br>- BESIC HASIM<br>- HALILOVIC OMAR<br>- STANIC MIHAJLO<br>- BAZINA ANTONIO<br>- BOSTANDZIC ANES<br>- ZAIMOVIC ALIJA   |                             |   |               |
| 2 | ROMANIA<br>- DOGARU ALEXANDRU_IONUT<br>- GRIGORIU STEFAN_ANTON<br>- MARIN MARIAN<br>- MOCANU VLADUT_PAUL<br>- MOISE LEONARD<br>- TORNACI ERHAN<br>- TUDOR DANIEL                         | ROMANIA                     |    | ROU - ROMANIA |
| 3 | CROATIA<br>- GUDELJ PETAR<br>- KATANEC JAN<br>- KVESIC LUKA<br>- DUBRAVCIC AXEL_ADAM<br>- FAJERBACH MAX<br>- TERIHAI IVAN<br>- SLUKIC JOSIP  | CROATIA                     |    | CRO - CROATIA |
| 3 | SERBIA<br>- CUBRILO LUKA<br>- GIRIC LUKA<br>- PEJOVIC UGLJESA<br>- ORLANDIC PETAR<br>- ZIVKOVIC OGNJEN<br>- GRUBIC MIHAJLO<br>- VASILIC MIHAJLO  | SERBIA                      |    | SRB - SERBIA  |
| 5 | GREECE<br>- MYTILIOS KONSTANTINOS<br>- TSEMPELIS ODYSSEAS<br>- KOSMAS AGGELOS<br>- KATSAKOULAS<br>CHRISTOFOROS<br>- MOKAS EVANGELOS<br>- KIOUPELIS DIMITRIOS<br>- ASIMAKOPOULOS ASIMAKIS | GREECE                      |  | GRE - GREECE  |
| 5 | KOSOVO<br>- BAJRAMI SEFER<br>- BERISHA_ARIAN_<br>- DEMIRI LUAN<br>- HALIMI QENDRIM<br>- IBRAHIMI DREN<br>- ISMAJLI GONI<br>- SAHITI JUSUF  | KOSOVO KARATE<br>FEDERATION |  | KOS - KOSOVO  |

**KATA TEAM CADET AND JUNIOR FEMALE**

|   |   |         |   |               |
|---|---|---------|---|---------------|
| 1 | TURKEY<br>- TUREMEN DAMLA_SU<br>- PEHLIVAN ASLI_BASAK<br>- KOYUNCU PERI | TURKEY  |  | TUR - TURKEY  |
| 2 | SERBIA<br>- MILOSEVIC NEDA<br>- JOVANOVIC SAVA<br>- GRBIC GORDANA       | SERBIA  |  | SRB - SERBIA  |
| 3 | CROATIA   | CROATIA |  | CRO - CROATIA |

**21st Balkan Karate Championships for Cadets,  
Juniors and U21 - RIJEKA 2021 - 2021-11-26**

**Official Results**

|   |   |                        |   |                              |  |
|---|---|------------------------|---|------------------------------|--|
|   | - GRGIC INGA<br>- HORVAT STELA<br>- PALIAGA FLAVIA  |                        |   |                              |  |
| 3 | GREECE<br>- PAPPACHRISTINA TRIADA<br>- PAVLITINA MARIA<br>- XENOU LYDIA LAMPRINI              | GREECE                 |  | GRE - GREECE                 |  |
| 5 | BOSNIA AND HERZEGOVINA<br>- PESTALIC MERJEMA<br>- SALIHOVIC ALDIJANA<br>- STANOJEVIC KRISTINA | BOSNIA AND HERZEGOVINA |  | BIH - BOSNIA AND HERZEGOVINA |  |

**KATA TEAM CADET AND JUNIOR MALE**

|   |   |                        |   |                              |  |
|---|---|------------------------|---|------------------------------|--|
| 1 | TURKEY<br>- KILIC YUSUF<br>- ASLAN GORKEM<br>- AKBABA ALI EFE                               | TURKEY                 |    | TUR - TURKEY                 |  |
| 2 | MACEDONIA KATA TEAM MALE<br>- ANDRICH HRISTIJAN<br>- SPASOVSKI DAVID<br>- STOJANOSKI ANDREJ | NORTH MACEDONIA        |    | MKD - NORTH MACEDONIA        |  |
| 3 | MONTENEGRO<br>- MILIC NIKOLA<br>- JANJIC ALEKSA<br>- GERSCHWITZ AJSEL                       | MONTENEGRO             |    | MNE - MONTENEGRO             |  |
| 3 | SERBIA<br>- NIKOLIC DIMITRIJE<br>- PAVLOVIC STEFAN<br>- BOSKOV ALEKSANDAR                   | SERBIA                 |   | SRB - SERBIA                 |  |
| 5 | BOSNIA AND HERZEGOVINA<br>- LUGONIC ZEMIR<br>- MEHULJIC AMIR<br>- ROSIC RIJAD               | BOSNIA AND HERZEGOVINA |  | BIH - BOSNIA AND HERZEGOVINA |  |
| 5 | CROATIA<br>- BRAVARIC CILO DAMJAN<br>- PARLOV NIKOLA<br>- KEKO LUKA                         | CROATIA                |  | CRO - CROATIA                |  |

**Kata Team female U21**

|   |   |            |   |                  |  |
|---|---|------------|---|------------------|--|
| 1 | SERBIA<br>- CRNOVIC SLAVICA<br>- MESIC MINA<br>- NIKOLIC MILICA       | SERBIA     |  | SRB - SERBIA     |  |
| 2 | MONTENEGRO<br>- CANOVIC DZENA<br>- DJUKANOVIC MASA<br>- MRAKOVIC MILA | MONTENEGRO |  | MNE - MONTENEGRO |  |

**Kata Team male U21**

|   |   |         |   |               |  |
|---|---|---------|---|---------------|--|
| 1 | CROATIA<br>- PREMEC IVOR<br>- KOKIC PATRIK<br>- ECIMOVIC MIHAEL | CROATIA |  | CRO - CROATIA |  |
|---|---|---------|---|---------------|--|

**Kumite Team female U21**

|   |         |         |   |               |  |
|---|---------|---------|---|---------------|--|
| 1 | CROATIA | CROATIA |  | CRO - CROATIA |  |
|---|---------|---------|---|---------------|--|

**21st Balkan Karate Championships for Cadets,  
Juniors and U21 - RIJEKA 2021 - 2021-11-26**

**Official Results**

|   |  |                 |   |                       |  |
|---|--|-----------------|---|-----------------------|--|
|   | - NUIC PETRA<br>- SULEK TIHANA<br>- VUKOJA LEA<br>- ZORKO MIA_GRETA  |                 |   |                       |  |
| 2 | SLOVENIA<br>- DAKOVIC LARA<br>- DEBELJAK HANA<br>- MOLNAR ELIZABETA<br>- POTISK LAURA                                      | SLOVENIA        |  | SLO - SLOVENIA        |  |
| 3 | SERBIA<br>- JANKOVIC BOJANA<br>- PEROVIC IVANA<br>- RADOVIC ANJA<br>- ZIVKOVIC TAMARA                                      | SERBIA          |  | SRB - SERBIA          |  |
| 3 | MACEDONIA KUMITE TEAM<br>FEMALE<br>- BOZHINOVSKA MAGDALENA<br>- ILIEVSKA IVANA<br>- JOVANOVSKA VIKTORIJA<br>- RAMO LORIANA | NORTH MACEDONIA |  | MKD - NORTH MACEDONIA |  |
| 5 | GREECE<br>- FRAGKOULI XRISOULA_VAGIA<br>- ORAIPOULOU STAVROULA<br>- KOUTALIARI KIRIAKI MARIA<br>- KOULOURIDOU PANAGIOTA    | GREECE          |  | GRE - GREECE          |  |

**Kumite Team male U21**

|   |  |                             |   |                                 |  |
|---|--|-----------------------------|---|---------------------------------|--|
| 1 | BOSNIA AND HERZEGOVINA<br>- ZIVKOVIC BRANKO<br>- MURADBASIC HARIS<br>- KRESIC SANDRO<br>- JOVANOVIC SRDJAN<br>- DZUHO RIJAD<br>- KATIC TOMISLAV<br>- TURULJA HAMZA               | BOSNIA AND<br>HERZEGOVINA   |  | BIH - BOSNIA AND<br>HERZEGOVINA |  |
| 2 | MACEDONIA KUMITE TEAM<br>MALE<br>- IDRIZ ABDURAHIM<br>- DZAMGJOZOV BOBAN<br>- BAJRAMI ILIR<br>- KURTANOVIC BERIZ<br>- PETKOV GLIGOR<br>- STOJANOVIKJ STEFAN<br>- SVINARSKI MARIO | NORTH MACEDONIA             |  | MKD - NORTH MACEDONIA           |  |
| 3 | SERBIA<br>- MILUTINOVIC MILOS<br>- STANOJEVIC STEFAN<br>- IVANOVIC NIKOLA<br>- KOVACEVIC PAVLE<br>- TOPUZOVIC ALEKSANDAR<br>- MASLAK NIKOLA<br>- POPOVIC MIHAJLO                 | SERBIA                      |  | SRB - SERBIA                    |  |
| 3 | KOSOVO<br>- BEKA ENDRIT<br>- GASHI MELOS<br>- MALIQI BETIM<br>- MEROVCI ALBIN<br>- REXHEPI MIRLIND<br>- SELMANI ALBINOT<br>- SHAQIRI ENDRIT                                      | KOSOVO KARATE<br>FEDERATION |  | KOS - KOSOVO                    |  |
| 5 | SLOVENIA   | SLOVENIA                    |  | SLO - SLOVENIA                  |  |



**21st Balkan Karate Championships for Cadets,  
Juniors and U21 - RIJEKA 2021 - 2021-11-26**

**Official Results**

|   |   |         |   |               |
|---|---|---------|---|---------------|
|   | - GAAL JAKA<br>- GORISEK MATEJ<br>- HUDALES TOMAZ<br>- KLOBASA ALEKS<br>- TAMSE NIKLAS<br>- VALENCAK_MIHAEL<br>- ZIDAR_DOMEN                  |         |   |               |
| 5 | CROATIA<br>- KALABIC ALEKSANDAR<br>- TOMLJANOVIC LEON<br>- SIMUNEC DINO<br>- LAZAR LEO<br>- PEHAR IVAN<br>- VUJEVIC ANTUN<br>- GLUHINIC DARIO | CROATIA |  | CRO - CROATIA |

**U21 Kata Female**

|    |                         |                          |   |                              |
|----|-------------------------|--------------------------|---|------------------------------|
| 1  | OZYANCAK TUGCE ELIF     | TURKEY                   |    | TUR - TURKEY                 |
| 2  | COLAK KEYDA NUR         | TURKEY                   |    | TUR - TURKEY                 |
| 3  | CRNOVIC SLAVICA         | SERBIA                   |    | SRB - SERBIA                 |
| 3  | RAGUZ IVANA             | CROATIA                  |    | CRO - CROATIA                |
| 5  | TSAGKERA SOFIA          | GREECE                   |    | GRE - GREECE                 |
| 5  | CESAR PIA               | SLOVENIA                 |   | SLO - SLOVENIA               |
| 7  | MRAKOVIC MILA           | MONTENEGRO               |  | MNE - MONTENEGRO             |
| 7  | ECIMOVIC MATEA          | CROATIA                  |  | CRO - CROATIA                |
| 9  | MOYSIDOU ANTONIA        | GREECE                   |  | GRE - GREECE                 |
| 9  | DJUKANOVIC MASA         | MONTENEGRO               |  | MNE - MONTENEGRO             |
| 11 | GANZITTI NIA            | SLOVENIA                 |  | SLO - SLOVENIA               |
| 11 | BEGANOVIC AMILA         | BOSNIA AND HERZEGOVINA   |  | BIH - BOSNIA AND HERZEGOVINA |
| 13 | NIKOLIC MILICA          | SERBIA                   |  | SRB - SERBIA                 |
| 13 | JANCHOVSKA KAROLINA     | NORTH MACEDONIA          |  | MKD - NORTH MACEDONIA        |
| 15 | MANCHEVSKA JOVANA       | NORTH MACEDONIA          |  | MKD - NORTH MACEDONIA        |
| 15 | MESIC MINA              | SERBIA                   |  | SRB - SERBIA                 |
| 17 | BOROVCANIN ISIDORA      | BOSNIA AND HERZEGOVINA   |  | BIH - BOSNIA AND HERZEGOVINA |
| 17 | KELESTURA SEMINA        | BOSNIA AND HERZEGOVINA   |  | BIH - BOSNIA AND HERZEGOVINA |
| 19 | PAVIC JELENA            | SERBIA                   |  | SRB - SERBIA                 |
| 19 | CANOVIC DZENA           | MONTENEGRO               |  | MNE - MONTENEGRO             |
| 21 | POPESCU MARIA ANASTASIA | ROMANIA                  |  | ROU - ROMANIA                |
| 23 | BUDAKOVA ANTONETA       | KOSOVO KARATE FEDERATION |  | KOS - KOSOVO                 |

**U21 Kata Male**

|   |                        |                 |   |                       |
|---|------------------------|-----------------|---|-----------------------|
| 1 | NIKOCEVIC KENAN        | MONTENEGRO      |  | MNE - MONTENEGRO      |
| 2 | BAKIC FILIP            | MONTENEGRO      |  | MNE - MONTENEGRO      |
| 3 | NEDELKOVSKI ALEKSANDAR | NORTH MACEDONIA |  | MKD - NORTH MACEDONIA |
| 3 | SUBOTA UROS            | SERBIA          |  | SRB - SERBIA          |
| 5 | STERNISA NEJC          | SLOVENIA        |  | SLO - SLOVENIA        |
| 5 | KOCAN ARIJAN           | MONTENEGRO      |  | MNE - MONTENEGRO      |
| 7 | KAYNAR OMER BERAT      | TURKEY          |  | TUR - TURKEY          |

**21st Balkan Karate Championships for Cadets,  
Juniors and U21 - RIJEKA 2021 - 2021-11-26**

**Official Results**

|    |                             |                          |   |                              |  |
|----|-----------------------------|--------------------------|---|------------------------------|--|
| 9  | KLOBASA BLAZ                | SLOVENIA                 |  | SLO - SLOVENIA               |  |
| 9  | NEDELICU ANDREI GABRIEL     | ROMANIA                  |  | ROU - ROMANIA                |  |
| 11 | KOSCEVIC LUKA               | CROATIA                  |  | CRO - CROATIA                |  |
| 11 | VELADZIC SENAI              | BOSNIA AND HERZEGOVINA   |  | BIH - BOSNIA AND HERZEGOVINA |  |
| 13 | DJORDJEVIC STRAHINJA        | SERBIA                   |  | SRB - SERBIA                 |  |
| 13 | MARKESINIS LAMPRINOS MARIOS | GREECE                   |  | GRE - GREECE                 |  |
| 15 | HALILOVIC OSMAN             | BOSNIA AND HERZEGOVINA   |  | BIH - BOSNIA AND HERZEGOVINA |  |
| 15 | ECIMOVIC MIHAEL             | CROATIA                  |  | CRO - CROATIA                |  |
| 17 | RASHITI LUNDRIT             | KOSOVO KARATE FEDERATION |  | KOS - KOSOVO                 |  |
| 17 | RISTIC DIMITRIJE            | SERBIA                   |  | SRB - SERBIA                 |  |
| 19 | MERDA ROBERT                | ROMANIA                  |  | ROU - ROMANIA                |  |
| 19 | SALKANOVIC OSMAN            | BOSNIA AND HERZEGOVINA   |  | BIH - BOSNIA AND HERZEGOVINA |  |

**U21 KUMITE FEMALE -50 KG**

|   |                  |                          |   |                       |  |
|---|------------------|--------------------------|---|-----------------------|--|
| 1 | GRCIC TAMARA     | SERBIA                   |    | SRB - SERBIA          |  |
| 2 | WEISMANN LARA    | CROATIA                  |    | CRO - CROATIA         |  |
| 3 | PETROVSKA MARIJA | NORTH MACEDONIA          |   | MKD - NORTH MACEDONIA |  |
| 3 | POLONIJO STELLA  | CROATIA                  |  | CRO - CROATIA         |  |
| 5 | DAKOVIC LARA     | SLOVENIA                 |  | SLO - SLOVENIA        |  |
| 5 | GASHI REDONA     | KOSOVO KARATE FEDERATION |  | KOS - KOSOVO          |  |
| 7 | BALIK HAZEL      | TURKEY                   |  | TUR - TURKEY          |  |

**U21 KUMITE FEMALE -55 KG**

|   |                        |                        |   |                              |  |
|---|------------------------|------------------------|---|------------------------------|--|
| 1 | SIPOVIC NEJRA          | BOSNIA AND HERZEGOVINA |  | BIH - BOSNIA AND HERZEGOVINA |  |
| 2 | HALILOVIC ALMINA       | BOSNIA AND HERZEGOVINA |  | BIH - BOSNIA AND HERZEGOVINA |  |
| 3 | JANKOVIC BOJANA        | SERBIA                 |  | SRB - SERBIA                 |  |
| 3 | SERATLIC NATALIJA      | SERBIA                 |  | SRB - SERBIA                 |  |
| 5 | KOULOURLIDOU PANAGIOTA | GREECE                 |  | GRE - GREECE                 |  |
| 5 | BUBER NURBADE          | TURKEY                 |  | TUR - TURKEY                 |  |
| 7 | BERGANT LAURA          | SLOVENIA               |  | SLO - SLOVENIA               |  |
| 7 | WEISMANN LUNA          | CROATIA                |  | CRO - CROATIA                |  |

**U21 KUMITE FEMALE -61 KG**

|   |                       |                        |   |                              |  |
|---|-----------------------|------------------------|---|------------------------------|--|
| 1 | ESER CAGLA            | TURKEY                 |  | TUR - TURKEY                 |  |
| 2 | NUIC PETRA            | CROATIA                |  | CRO - CROATIA                |  |
| 3 | ZIVKOVIC TAMARA       | SERBIA                 |  | SRB - SERBIA                 |  |
| 3 | KURTES MARINA         | BOSNIA AND HERZEGOVINA |  | BIH - BOSNIA AND HERZEGOVINA |  |
| 5 | RAJIC MONIKA          | BOSNIA AND HERZEGOVINA |  | BIH - BOSNIA AND HERZEGOVINA |  |
| 5 | BOZHINOVSKA MAGDALENA | NORTH MACEDONIA        |  | MKD - NORTH MACEDONIA        |  |
| 7 | RAMO LORIANA          | NORTH MACEDONIA        |  | MKD - NORTH MACEDONIA        |  |
| 7 | MUJAKOVIC NEJLA       | BOSNIA AND HERZEGOVINA |  | BIH - BOSNIA AND HERZEGOVINA |  |

**21st Balkan Karate Championships for Cadets,  
Juniors and U21 - RIJEKA 2021 - 2021-11-26**

**Official Results**

| <b>U21 KUMITE FEMALE -68 KG</b> |                        |                          |   |                              |
|---------------------------------|------------------------|--------------------------|---|------------------------------|
| 1                               | MOLNAR ELIZABETA       | SLOVENIA                 |  | SLO - SLOVENIA               |
| 2                               | BUSNOV ALMEDINA        | BOSNIA AND HERZEGOVINA   |  | BIH - BOSNIA AND HERZEGOVINA |
| 3                               | KASATURA HIRA NUR      | TURKEY                   |  | TUR - TURKEY                 |
| 3                               | QERIMI VLERA           | KOSOVO KARATE FEDERATION |  | KOS - KOSOVO                 |
| 5                               | VUKOJA LEA             | CROATIA                  |  | CRO - CROATIA                |
| 5                               | HALILOVIC ELVEDINA     | BOSNIA AND HERZEGOVINA   |  | BIH - BOSNIA AND HERZEGOVINA |
| 7                               | RADOVIC ANJA           | SERBIA                   |  | SRB - SERBIA                 |
| 7                               | ORAIPOPOULOU STAVROULA | GREECE                   |  | GRE - GREECE                 |

| <b>U21 KUMITE FEMALE 68+ KG</b> |                   |                        |   |                              |
|---------------------------------|-------------------|------------------------|---|------------------------------|
| 1                               | JOVANOVIC MILENA  | MONTENEGRO             |    | MNE - MONTENEGRO             |
| 2                               | VARSAKOVIC MINJA  | SERBIA                 |    | SRB - SERBIA                 |
| 3                               | PEROVIC IVANA     | SERBIA                 |    | SRB - SERBIA                 |
| 3                               | UYGUR FATMA       | TURKEY                 |    | TUR - TURKEY                 |
| 5                               | KRESIC STEFANI    | BOSNIA AND HERZEGOVINA |    | BIH - BOSNIA AND HERZEGOVINA |
| 5                               | BRKAN NEJLA       | BOSNIA AND HERZEGOVINA |    | BIH - BOSNIA AND HERZEGOVINA |
| 7                               | MILOSEVIC TEODORA | SERBIA                 |  | SRB - SERBIA                 |

| <b>U21 KUMITE MALE -60 KG</b> |                     |                        |   |                              |
|-------------------------------|---------------------|------------------------|---|------------------------------|
| 1                             | DUJAKOVIC PAVLE     | BOSNIA AND HERZEGOVINA |  | BIH - BOSNIA AND HERZEGOVINA |
| 2                             | TAMSE NIKLAS        | SLOVENIA               |  | SLO - SLOVENIA               |
| 3                             | BOJIC MATIJA        | MONTENEGRO             |  | MNE - MONTENEGRO             |
| 3                             | NASTEV TODOR        | BULGARIA               |  | BUL - BULGARIA               |
| 5                             | RUMENJAK NOA        | CROATIA                |  | CRO - CROATIA                |
| 5                             | TOPLICANEC KRISTIAN | CROATIA                |  | CRO - CROATIA                |
| 7                             | VALENCAK MIHAEL     | SLOVENIA               |  | SLO - SLOVENIA               |
| 7                             | OZDEMIR BURAK       | TURKEY                 |  | TUR - TURKEY                 |

| <b>U21 KUMITE MALE -67 KG</b> |                   |                          |   |                              |
|-------------------------------|-------------------|--------------------------|---|------------------------------|
| 1                             | BEKA ENDRIT       | KOSOVO KARATE FEDERATION |  | KOS - KOSOVO                 |
| 2                             | MEROVCI ALBIN     | KOSOVO KARATE FEDERATION |  | KOS - KOSOVO                 |
| 3                             | SELMANAJ ARLIND   | KOSOVO KARATE FEDERATION |  | KOS - KOSOVO                 |
| 3                             | HUDALES TOMAZ     | SLOVENIA                 |  | SLO - SLOVENIA               |
| 5                             | MILUTINOVIC MILOS | SERBIA                   |  | SRB - SERBIA                 |
| 5                             | ORESKOVIC PETAR   | CROATIA                  |  | CRO - CROATIA                |
| 7                             | OMEROVIC BAKIR    | BOSNIA AND HERZEGOVINA   |  | BIH - BOSNIA AND HERZEGOVINA |
| 7                             | SUMAR MUHAMED     | BOSNIA AND HERZEGOVINA   |  | BIH - BOSNIA AND HERZEGOVINA |

**21st Balkan Karate Championships for Cadets,  
Juniors and U21 - RIJEKA 2021 - 2021-11-26**

**Official Results**











| <b>U21 KUMITE MALE -75 KG</b> |                         |                          |   |                              |
|-------------------------------|-------------------------|--------------------------|---|------------------------------|
| 1                             | AKKURT EREN             | TURKEY                   |  | TUR - TURKEY                 |
| 2                             | YURUR OMER FARUK        | TURKEY                   |  | TUR - TURKEY                 |
| 3                             | MALIQI BETIM            | KOSOVO KARATE FEDERATION |  | KOS - KOSOVO                 |
| 3                             | TURULJA HAMZA           | BOSNIA AND HERZEGOVINA   |  | BIH - BOSNIA AND HERZEGOVINA |
| 5                             | ZUKIC AFAN              | BOSNIA AND HERZEGOVINA   |  | BIH - BOSNIA AND HERZEGOVINA |
| 5                             | MARKOVIC LEO            | CROATIA                  |  | CRO - CROATIA                |
| 7                             | KAMPOUGERIS CHARALAMPOS | GREECE                   |  | GRE - GREECE                 |
| 7                             | SIMUNEC DINO            | CROATIA                  |  | CRO - CROATIA                |

| <b>U21 KUMITE MALE -84 KG</b> |                        |                          |   |                              |
|-------------------------------|------------------------|--------------------------|---|------------------------------|
| 1                             | DZUHO MAHIR            | BOSNIA AND HERZEGOVINA   |    | BIH - BOSNIA AND HERZEGOVINA |
| 2                             | GASHI MELOS            | KOSOVO KARATE FEDERATION |    | KOS - KOSOVO                 |
| 3                             | TOMLJANOVIC LEON       | CROATIA                  |    | CRO - CROATIA                |
| 3                             | BALIKCIOGLU ABDULKERIM | TURKEY                   |    | TUR - TURKEY                 |
| 5                             | SADIKOVIC EMIL         | BOSNIA AND HERZEGOVINA   |    | BIH - BOSNIA AND HERZEGOVINA |
| 5                             | MURADBASIC HARIS       | BOSNIA AND HERZEGOVINA   |  | BIH - BOSNIA AND HERZEGOVINA |
| 7                             | DZAMGJOZOV BOBAN       | NORTH MACEDONIA          |  | MKD - NORTH MACEDONIA        |

| <b>U21 KUMITE MALE 84+ KG</b> |                    |                        |   |                              |
|-------------------------------|--------------------|------------------------|---|------------------------------|
| 1                             | DZUHO RIJAD        | BOSNIA AND HERZEGOVINA |  | BIH - BOSNIA AND HERZEGOVINA |
| 2                             | STOJANOVIKJ STEFAN | NORTH MACEDONIA        |  | MKD - NORTH MACEDONIA        |
| 3                             | KRESIC SANDRO      | BOSNIA AND HERZEGOVINA |  | BIH - BOSNIA AND HERZEGOVINA |
| 3                             | KARVOUNIS SERGIOS  | GREECE                 |  | GRE - GREECE                 |
| 5                             | JOVOVIC NEMANJA    | MONTENEGRO             |  | MNE - MONTENEGRO             |
| 5                             | BAZDARIC ANTON     | CROATIA                |  | CRO - CROATIA                |
| 7                             | PEHAR IVAN         | CROATIA                |  | CRO - CROATIA                |
| 7                             | GENC KADIR FURKAN  | TURKEY                 |  | TUR - TURKEY                 |

21st Balkan Karate Championships for Cadets,  
Juniors and U21 - RIJEKA 2021 - 2021-11-26

Medals - Nation

| Rank | Nation  | 1. Place | 2. Place | 3. Place |
|------|---|----------|----------|----------|
| 1    |  BOSNIA AND HERZEGOVINA, BIH | 12       | 4        | 10       |
| 2    |  TURKEY, TUR                 | 9        | 6        | 9        |
| 3    |  SERBIA, SRB                 | 7        | 8        | 16       |
| 4    |  CROATIA, CRO                | 5        | 6        | 12       |
| 5    |  NORTH MACEDONIA, MKD        | 2        | 3        | 8        |
| 6    |  MONTENEGRO, MNE             | 2        | 3        | 5        |
| 7    |  GREECE, GRE                 | 2        | 2        | 9        |
| 8    |  KOSOVO, KOS                 | 2        | 2        | 5        |
| 9    |  SLOVENIA, SLO               | 1        | 3        | 3        |
|      |  ROMANIA, ROU                | 1        | 3        | 3        |
| 11   |  BULGARIA, BUL               | 0        | 2        | 2        |